

Compact C Range C系列泵

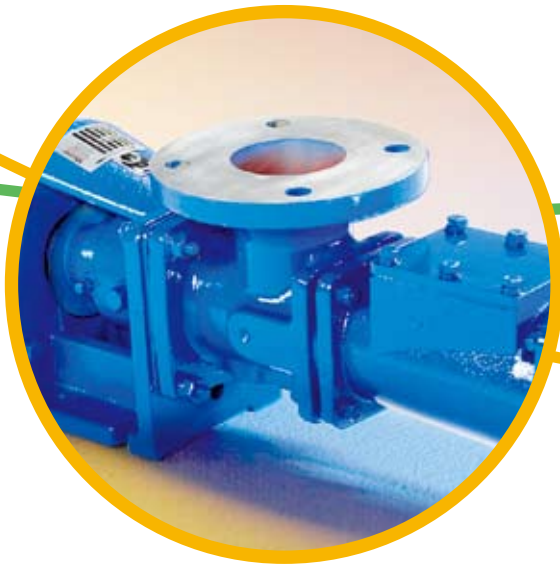

Mono[®] **NOV**

One Company, Unlimited Solutions

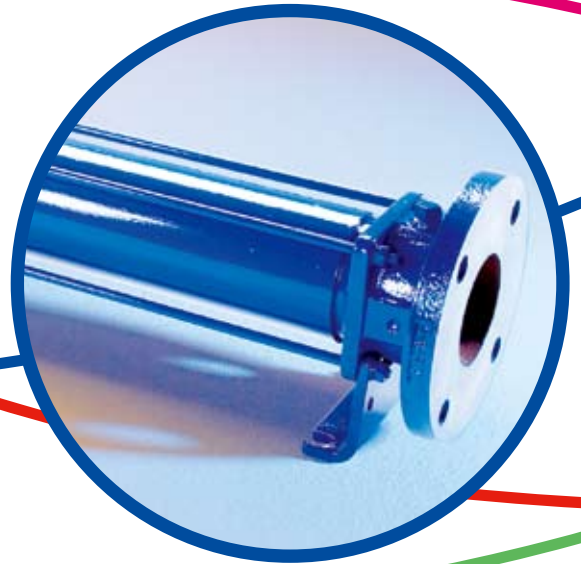
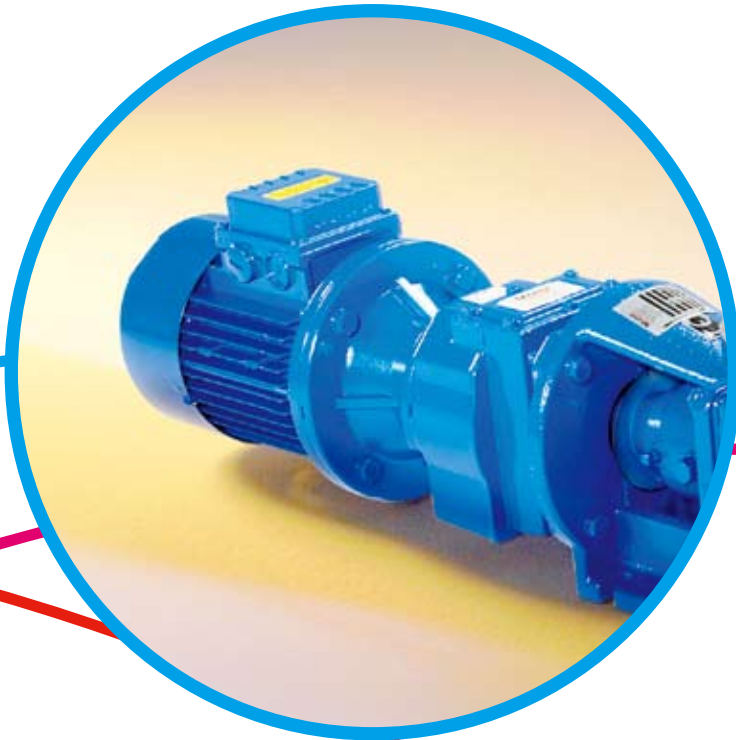
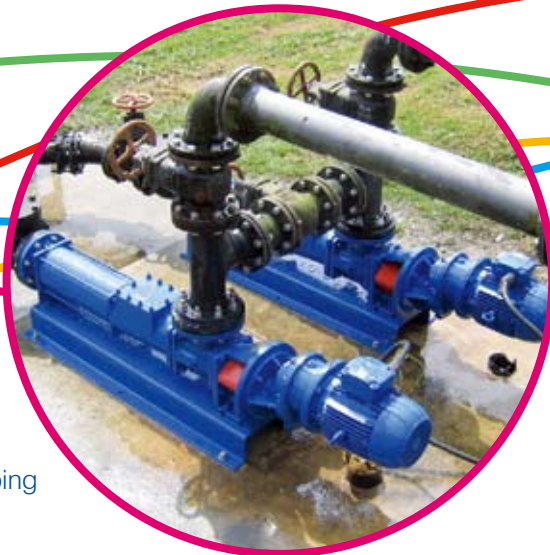

Sludge pumping
输送污泥

Features & Benefits 性能参数

Capacity
流量 最大可达
224m³/hr

Pressure
压力 最大可达
24bar

Temperature
温度 -10°C up to 100°C

Typical applications include:
主要应用于:

- Domestic and industrial effluents
生活和工业废水
- Hydrated lime slurry
石灰浆料
- Sludge
污泥
- Shear sensitive latex emulsion
对剪切力敏感的乳胶等
- Milk curds, sauces, fruit juices
牛奶, 调味品, 果汁等
- Industrial chemicals and detergents
化工原料和清洁剂
- Starch slurries
淀粉浆料
- Coating clays, gypsum and silicate
涂料, 石膏和硅酸盐
- Paper stocks
造纸
- Agricultural slurries
农业泥浆

“A competitively priced progressing cavity pump, with a compact construction and maximum performance characteristics.”

C系列泵是一种结构紧凑，性能优异，具有价格优势的单螺杆泵。

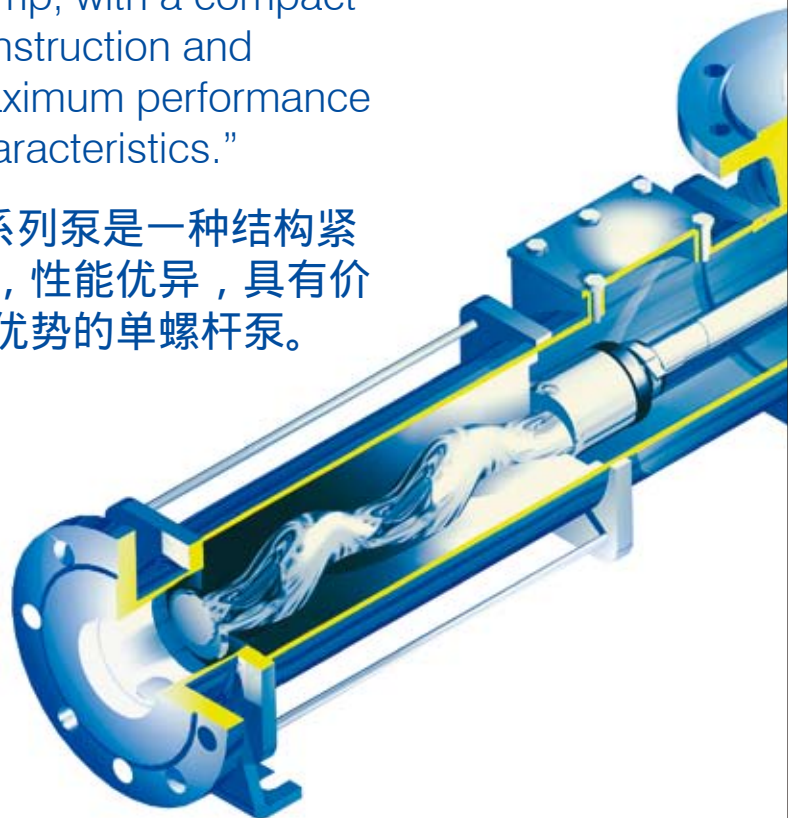

Materials of construction 泵体材料
Available in cast iron or stainless steel, with a choice of rotor and stator materials to suit individual applications e.g. hard chrome plated rotor or natural rubber stator.

泵体材料为铸铁或者不锈钢，根据客户要求，各种定转子材料包括硬铬镀层转子等可供选择。

High pressure / long haul pumping 高压力，高扬程

Can offer considerable project cost savings by utilising small bore pipework and eliminating the need for a series of pumps, when pumping over long distances or with high head requirements.

长距离或者高扬程输送工况下，可以通过减小管路管径或者减少泵的数量等，降低了投资成本。

Low running speeds 低运行转速

Reduced wear for a longer working pump life which extends the periods between routine maintenance. Think of the savings you could make on abrasive applications.

泵的运行转速降低，减少了设备的磨损和日常维护，从而延长了泵的使用时间并增加了经济性。



Waste water pumping
污水输送

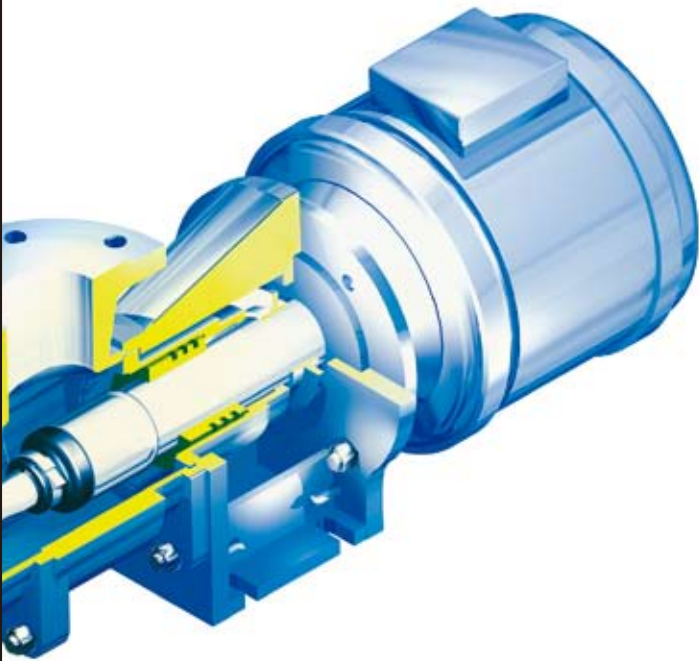

Compact unit 直连型结构

As the drive forms an integral part of the unit, the pump is ideal for space-saving installations.

电机和泵为直连结构，安装空间小。

Gentle pumping action 运行平稳

Minimises shear and crush damage to the pumped product.

降低了剪切力和震动对泵的影响。

Surface mounted 泵表面安全处理

Making it easier, cleaner and less hazardous for maintenance.

泵表面易于清洁，减少维护时的危险。

Up to 8.5m suction lift 高自吸能力

Deep sumps can be easily pumped without the use of submersible equipment.

高达8.5米的自吸能力，保证了不需要其它水下设备，泵能高性能运行。

Plug in shaft 联轴杆结构

Ease of maintenance when assembling or dismantling, with extraction facility.

维护的时候，便于拆卸和安装。

Viscous products 多样的产品系列

The pump can be supplied with a square inlet and conveyor to assist viscous slurries into the pumping element.

通过加装方形进料口和螺旋输送机，可以用来输送粘度较高的介质。

Inspection cover 检查口端盖

Available for applications where rag content is a problem.

当介质中有固体颗粒或者纤维时，可以选择安装检查端盖。

Baseplate 底座

Pumps are supplied on a baseplate to ease installation.

泵整体安装在同一底座上，便于安装。

Sealed joints 密封的传动结构

Fully sealed drive train to maximise life and minimise downtime.

密封的传动装置保证了最长的使用时间减少了维护时间。

Shaft sealing options 轴密封

Packed gland or single and double mechanical seals are available.

填料密封，单端面机械密封或者双端面机械密封可供选择。

Versatile 可垂直安装

Can be installed vertically or horizontally to suit the application. Can be run in either direction.

根据要求可垂直或水平安装，泵旋转方向可调。

Robust drives 驱动减速电机

Specially selected drives and gearboxes for longer life. Options include electric motor drive units supplied as overhead vee belt driven, direct-coupled or variable speed drives with mechanical variable speed or frequency inverter.

各种减速电机，包括变频电机，皮带式可调速电机，摩擦盘减速电机等可供选择。

Duracoat coating 转子镀层

Rotors can be supplied with Mono's range of specialist coatings to help extend the life of the rotors by increasing wear and corrosion resistance.

Mono 的各种转子镀层，可以大大提高转子的硬度和耐磨性能，从而提高转子的使用寿命。

Handles gas entrainment 三相混输

No air or gas locking in the pump. The positive seal formed by the interference fit between rotor and stator enables the pump to self prime and it also allows tri-phase liquids i.e. solids, gases and liquids to be handled easily.

Mono泵定转子的结构可以保证在固液气三相混输时有良好的使用效果。

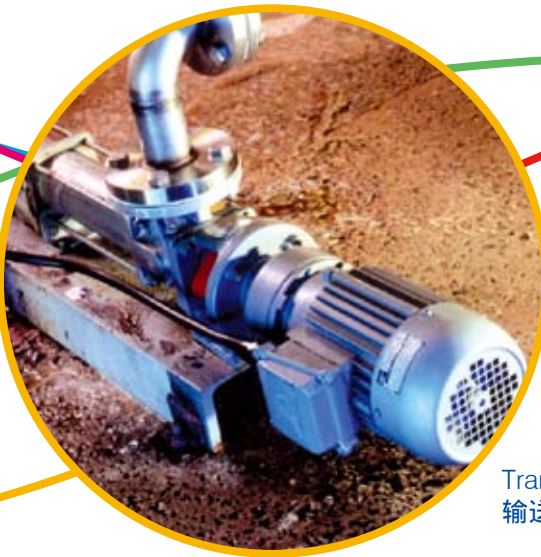

Transfer of industrial detergents
输送清洁剂

Product Dimensions 产品尺寸

MODEL	A	A1	B	C	D	E	F	G	H
C21B	429	115	296	133	1 1/4"	144	85	120	160
C21D	573	250	440	133	1 1/4"	144	85	120	160
C22A	429	115	296	133	1 1/4"	144	85	120	160
C22B	573	250	440	133	1 1/4"	144	85	120	160
C22D	959	525	822	137	1 1/2"	148	85	120	160
C23A	520	165	383	137	1 1/2"	148	85	120	160
C23B	665	300	528	137	1 1/2"	148	85	120	160
C23K	665	300	528	137	1 1/2"	148	85	120	160

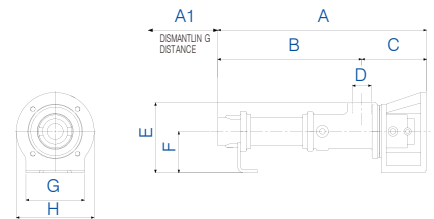

MODEL	A	A1	B	C	D	E	F	G	H
C1XK	750	300	593	157	50	190	85	120	160
C14K	986	455	756	230	65	227	112	140	200
C15K	1102	570	882	220	80	232	112	140	200
C16K	1272	680	1036	236	100	255	125	160	250
C17K	1478	800	1198	281	125	310	150	180	300
C18K	1654	880	1374	280	125	310	150	180	300
C19K	1856	990	1541	315	150	345	160	200	300
C1AK	2007	1100	1692	315	150	345	160	200	300
C1BK	2437	1210	2009	427	200	450	225	280	350
C13D	1160	525	930	230	65	227	112	140	200
C2XA	566	135	409	157	50	190	85	120	160
C2XB	749	315	592	157	50	227	112	120	160
C1XD	1363	650	1086	277	80	245	125	160	250
C14A	781	250	551	230	65	227	112	140	200
C14B	986	455	756	230	65	227	112	140	200
C14D	1462	780	1185	277	80	245	125	160	250
C15A	842	310	622	220	80	232	112	140	200
C15B	1159	570	882	277	80	245	125	160	250
C15D	1776	1005	1457	319	100	280	150	180	300
C16A	960	365	724	236	100	255	125	160	250
C16B	1355	680	1306	319	100	280	150	180	300
C16D	2181	1210	1813	369	125	320	160	200	300
C17A	1110	430	830	281	125	310	150	180	300
C17B	1478	800	1198	281	125	310	150	180	300
C17D	2626	1385	2224	402	150	410	225	280	350
C18A	1246	475	966	281	125	310	150	180	300
C18B	1742	880	1374	386	125	320	160	200	300
C18D	2786	1555	2384	402	150	410	225	280	350
C19A	1394	530	1079	315	150	345	160	200	300
C19B	1856	990	1541	315	150	345	160	200	300
C1AA	1476	610	1161	315	150	345	160	200	300
C1AB	2159	1100	1756	402	150	410	225	280	350
C1BA	1794	640	1366	427	200	450	225	280	350

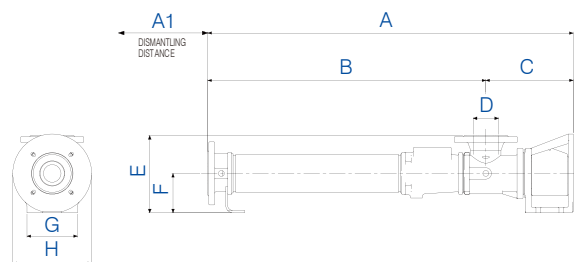

MODEL	A	A1	B	C	D	E	F	G	H
S14A	781	250	526	255	165x165	236	112	140	200
S14K	986	455	731	255	165x165	236	112	140	200
S15A	842	310	587	255	165x165	236	112	140	200
S15K	1102	570	847	255	165x165	236	112	140	200
S16A	960	365	674	286	200x200	260	125	160	250
S16K	1272	680	986	286	200x200	260	125	160	250
S17A	1110	430	777	333	240x240	310	150	180	300
S17K	1478	800	1145	333	240x240	310	150	180	300
S18A	1246	475	912	334	240x240	310	150	180	300
S18K	1654	880	1320	334	240x240	310	150	180	300

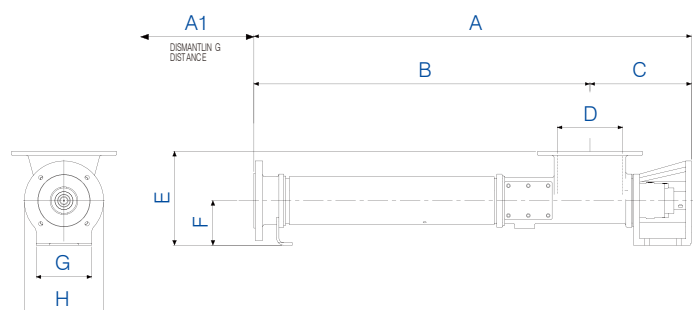

- 1、如无特殊说明，所有尺寸单位为mm。
- 2、A1为推荐的预留空间尺寸。全面准确的安装图请咨询MONO公司。



Pumping of slurry mix
输送混合泥浆

Performance Data 性能参数

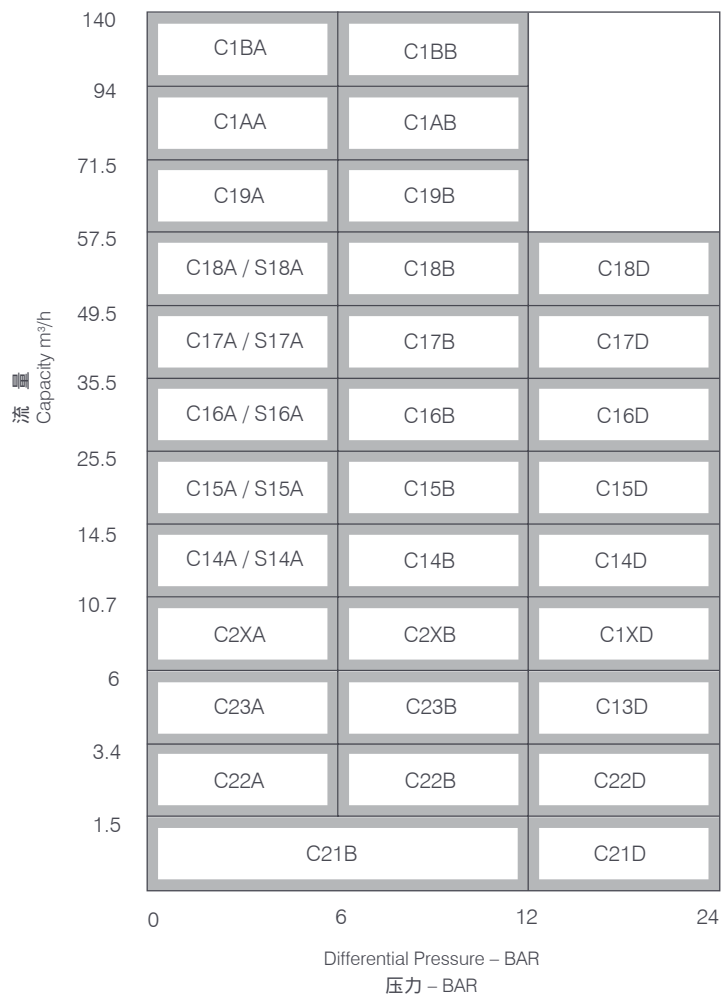
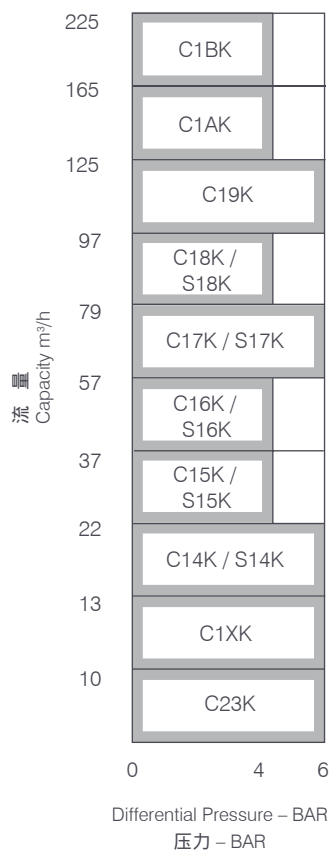

详细选型，可咨询MONO公司。

Motor/Baseplate Dimensions 减速电机和底板的安装尺寸

MODEL 型号	LENGTH 长度	WIDTH 宽度	HEIGHT 高度
C1XK	1304	300	304
C14K	1665	300	475
C15K	1777	360	475
C16K	1947	360	488
C17K	2464	360	609
C18K	2640	420	609
C19K	2902	420	649
C1AK	3053	420	649
C1BK	3481	520	537
C13D	1835	360	475
C2XA	1120	300	304
C2XB	1329	300	304
C1XD	2038	420	488
C14A	1456	300	475
C14B	1665	300	475
C14D	2137	360	488
C15A	1517	300	475
C15B	1834	360	488
C15D	2762	420	609
C16A	1635	360	488
C16B	2341	420	609
C16D	3225	520	472
C17A	2066	360	584
C17B	2464	360	609
C17D	3672	520	727
C18A	2202	360	584
C18B	2788	420	649
C18D	3830	520	537
C19A	2440	420	649
C19B	2902	420	649
C1AA	2522	420	649
C1AB	3205	520	727
C1BA	2840	520	727

MODEL 型号	LENGTH 长度	WIDTH 宽度	HEIGHT 高度
C21B	984	300	304
C21D	1149	300	304
C22A	984	300	304
C22B	1149	300	304
C22D	1544	300	304
C23A	1084	300	304
C23B	1234	300	304
C23K	1234	300	304

MODEL 型号	LENGTH 长度	WIDTH 宽度	HEIGHT 高度
S14A	1456	300	475
S14K	1665	300	475
S15A	1517	300	475
S15K	1777	360	475
S16A	1635	360	488
S16K	1947	360	488
S17A	2066	360	584
S17K	2464	360	609
S18A	2202	360	584
S18K	2640	420	609

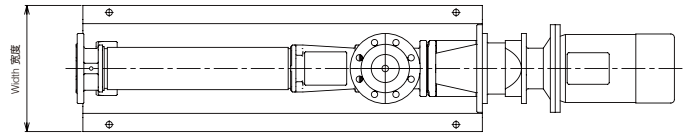
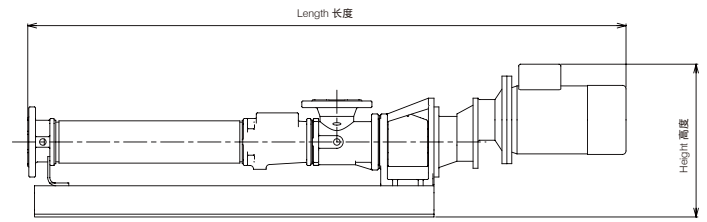

- 1、如无特殊说明,所有尺寸单位为mm。
- 2、这些尺寸为典型安装示例,仅供参考。实际使用尺寸请咨询MONO公司。



Published information other than that marked CERTIFIED does not extend any warranty or representation, expressed or implied, regarding these products. Any such warranties or other terms and conditions of sales and products shall be in accordance with Mono Pumps Limited standard terms and conditions of sale, available on request.
 © Mono Pumps Limited August 2007 Literature reference: MPSB/01/01
 Mono® is a registered trademark of Mono Pumps Ltd.
 Registered in England No 300721

Mono® **NOV**

One Company, Unlimited Solutions