

4100 SERIES

Condensate Pumps - Steel Tank

Technical Specifications

Sterlco® 4100 Series Condensate Pumps set new standards of performance. Reliable and efficient, each unit features heavy gauge, 3/16" steel receivers for long operating life.

In addition, 3450 RPM motors assure maximum efficiency while maintaining minimum motor horsepower. Available in a wide range of sizes, these U.S. made pumps have just the right accessories and options to meet your unique needs.

What's more, a nationwide network of stocking distributors means fast, easy, year-round access to pumps and replacement parts.



4100 Series
Duplex Construction
(Shown with optional control panel & isolation valve)

Features

Standard Features

- Heavy gauge steel receivers
- Simplex or duplex construction
- Bronze fitted centrifugal pumps
- Energy efficient 3450 RPM motors
- Automatic venting
- "Sterl-Seal" ceramic pump seal (250°F)
- Heavy-duty float switch
- Wide range of options and accessories

Optional Features

- Mechanical and electrical alternators
- Gauge glass
- Thermometer
- Discharge pressure gauges
- Isolation valves
- Special motor construction, such as totally enclosed, washdown duty and explosion proof is available
- Magnetic starters with H-O-A selector switches
- 1750 RPM motors, larger pumping capacities and higher discharge pressures - consult factory
- 120 gallon, custom sized and elevated tanks are available
- Complete NEMA 12 Control Panel



Simplex Construction



Duplex Construction

Product Features



Motors:

Heavy-duty, ball-bearing, close-coupled pump motors with stainless steel shaft. 3450 RPM for greater efficiency and more economical operation.

Float Switch:

Two-pole, drip proof case, stainless steel float and float rod, double-break silver-to-silver contacts. Float travel adjustment is easy, visible and accessible.

Automatic Venting:

Provides for efficient operation and long life by venting air and flushing seal area.

Large Tanks:

Plenty of capacity for maximum rating of pump. Return inlet is low Occupies a minimum of floor space

Impeller:

Made of brass for long life. Efficient design provides maximum capacity, minimum motor load.

“SterlSeal” Pump seal (A):

Features the ultimate in ceramic technology for exceptionally long life. Because the seal runs on the bronze impeller hub, the motor shaft is literally outside the pump. Consequently, the shaft is not exposed to corrosion by condensate. Rated for temperatures up to 250°F.

Isolation Valve (B):

Optional on 4100 Series Condensate Pumps. Allows removal of pump without draining the tank.

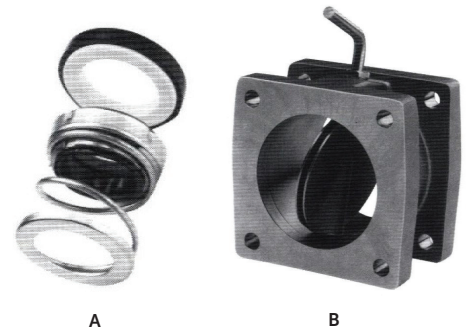

Control Panel

Complete NEMA 12 Control Panel (Optional)

- Motor Circuit Protector
- HOA Selector Switch
- External Reset
- Control Circuit Transformer
- Pilot Light (pump running)
- Removable Mounting Plate and Terminal Strip in a Single NEMA 12 Enclosure
- Mounted and Wired with Single Point Power Connection.

Specifications

4100 Series Engineering and Capacity Data

Capacity Sq. Ft. EDR	Discharge Pressure PSI	Pump Capacity, GPM	Motor HP	Rec. Capacity, Gallons	Unit Model Number		Shipping Weight, lbs.	
					Simplex	Duplex	Simplex	Duplex
8,000	20	12	1/3	8	4028G	-	90	-
2,000	20	3	1/3	15	4122-G	4122-GD	125	185
4,000		6	1/3		4124-G	4124-GD	125	185
6,000		9	1/3		4126-G	4126-GD	125	185
8,000		12	1/3		4128-G	4128-GD	125	185
10,000	20	15	1/2	30	41210-G	41210-GD	190	240
15,000		22.5	1/2		41215-G	41215-GD	190	240
20,000		30	3/4		41220-G	41220-GD	200	250
25,000	20	37.5	3/4	45	41225-J	41225-JD	285	350
30,000		45	1		41230-J	41230-JD	285	355
40,000	20	60	1-1/2	60	41240-J	41240-JD	335	405
50,000	20	75	2	95	41250-J	41250-JD	385	460
2,000	30	3	1/2	15	4132-J	4132-JD	180	250
4,000		6	1/2		4134-J	4134-JD	180	250
6,000		9	1/2		4136-J	4136-JD	180	250
8,000		12	1/2		4138-J	4138-JD	180	250
10,000		15	3/4		41310-J	41310-JD	185	255
15,000	30	22.5	1	30	41315-J	41315-JD	230	300
20,000		30	1		41320-J	41320-JD	230	300
25,000	30	37.5	1	45	41325-J	41325-JD	285	350
30,000		45	1-1/2		41330-J	41330-JD	290	355
40,000	30	60	2	60	41340-J	41340-JD	340	410
50,000	30	75	3	95	41350-J	41350-JD	395	470
2,000	40	3	1	15	4142-J	4142-JD	190	270
4,000		6	1		4144-J	4144-JD	190	270
6,000		9	1		4146-J	4146-JD	190	270
8,000		12	1		4148-J	4148-JD	190	270
10,000		15	1		41410-J	41410-JD	190	270
15,000	40	22.5	1-1/2	30	41415-J	41415-JD	240	310
20,000		30	1-1/2		41420-J	41420-JD	240	310
25,000	40	37.5	1-1/2	45	41425-J	41425-JD	290	355
30,000		45	2		41430-J	41430-JD	295	360
40,000	40	60	2	60	41440-J	41440-JD	340	410
50,000	40	75	3	95	41450-J	41450-JD	395	470
2,000	50	3	2	15	4152-J	4152-JD	195	275
4,000		6	2		4154-J	4154-JD	195	275
6,000		9	2		4156-J	4156-JD	195	275
8,000		12	2		4158-J	4158-JD	195	275
10,000		15	2		41510-J	41510-JD	195	275
15,000	50	22.5	2	30	41515-J	41515-JD	245	320
20,000		30	3		41520-J	41520-JD	255	330

Sample Specification

Furnish and install, where indicated on plans, a Sterling 4100 Series (simplex or duplex) condensate pump, having a capacity of _____ sq. ft. E.D.R. _____ GPM against a discharge pressure of _____ PSI. The receiver shall have a capacity of _____ gallons and be of 3/16" steel construction. Pump(s) shall be of the centrifugal type with two-piece enclosed brass impeller, cast iron housing, high temperature (250°F) mechanical seal and stainless steel motor shaft. The float switch shall be two-pole with plastic case, stainless steel float and shaft, and double-break silver contacts. A flat perforated brass strainer shall be provided at the inlet to the pump from the tank. The motor(s) shall be vertical, 3450 RPM, _____ phase, _____ volt, 60 cycle, _____ H.P. The complete unit is to be factory assembled and tested prior to shipment.

Product Diagrams

G series (simplex)
8 or 15 gallon tank

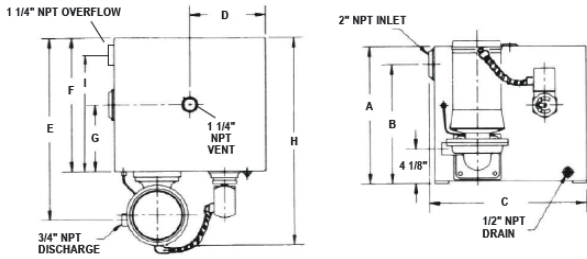

J series (duplex)
15 gallon tank

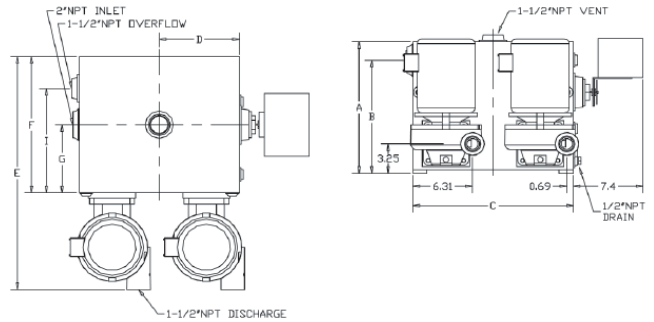

G series (duplex)
15 gallon tank

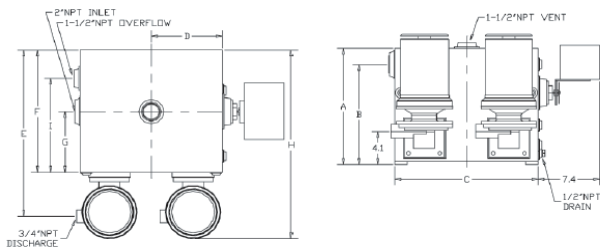

J series (simplex)
15 gallon tank

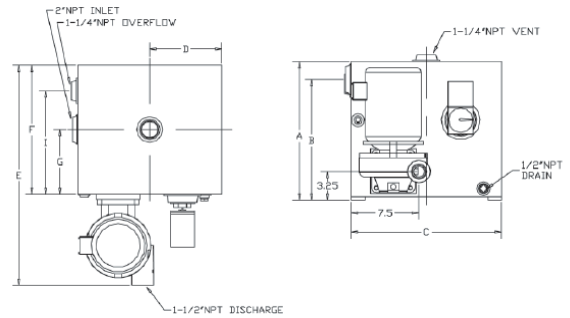

G series
30-120 gallon tanks

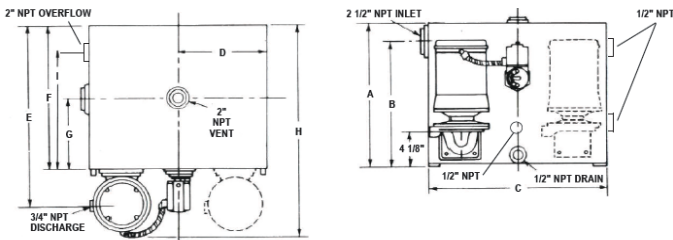

J series
30-120 gallon tanks

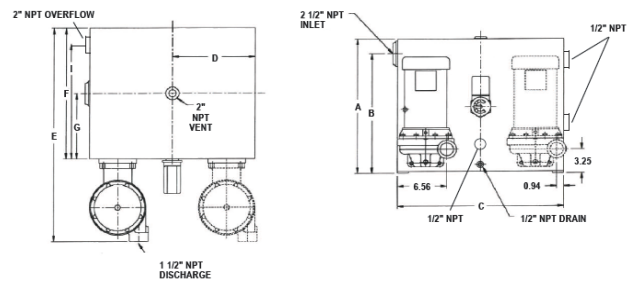

Receiver	A	B	C	D	E	F	G	H	I
8 G	12.50	10.50	12.50	6.25	18.00	12.50	6.25	21.50	10.25
15 G	14.38	12.38	17.00	8.50	20.50	15.00	7.50	23.25	11.50
15 J	14.38	12.38	17.00	8.50	26.31	15.00	7.50		11.50
30 G	18.38	16.12	22.00	11.00	23.50	18.00	9.00	28.00	13.50
30 J	18.38	16.12	22.00	11.00	29.31	18.00	9.00		13.50
45 G	26.38	24.12	22.00	11.00	23.50	18.00	9.00	28.00	13.50
45 J	26.38	24.12	22.00	11.00	29.31	18.00	9.00		13.50
60 G	28.38	26.12	28.00	14.00	23.50	18.00	9.00	28.00	13.50
60 J	28.38	26.12	28.00	14.00	29.31	18.00	9.00		13.50
95 G	28.38	26.12	28.00	14.00	33.50	28.00	14.00	38.00	23.50
95 J	28.38	26.12	28.00	14.00	39.31	28.00	14.00		23.50
120 G	36.38	33.75	28.00	14.00	33.50	28.00	14.00	38.00	23.50
120 J	36.38	33.75	28.00	14.00	39.31	28.00	14.00		23.50