



**RIFTEK**  
Sensors & Instruments



## **DISC BRAKES PROFILE GAUGE**

**IKD Series**

**User's manual**

## Contents

1.	Safety precautions and measurement conditions .....	4
2.	CE compliance.....	4
3.	Laser safety.....	4
4.	General information.....	4
5.	Basic technical data.....	5
6.	Example of designation when ordering.....	5
7.	Complete set to be supplied.....	5
8.	Device structure.....	6
8.1.	Basic components of the device and their functions.....	6
8.1.1.	Digital readout device.....	7
8.1.2.	Laser scanning module.....	8
8.1.3.	Removable bracket installation.....	11
8.2.	Calibration blocks.....	12
9.	Operation principle.....	13
10.	Geometric parameters of the brake disc under control.....	13
10.1.	Brake disc thickness.....	13
10.2.	Brake disc wear.....	13
10.3.	Overall brake disc thickness.....	13
11.	First activation and measurement procedure.....	14
11.1.	Activation.....	14
11.2.	Measurement.....	15
12.	PDA basic parameters setting.....	16
12.1.	Measurement type.....	17
12.2.	Units of measurement.....	17
12.3.	Date/time setting.....	18
12.4.	Device selection.....	18
12.5.	Language setting.....	19
12.6.	Synchronization with PC.....	20
13.	Calculation settings.....	21
13.1.	Calculation methods.....	21
13.2.	Selection of displayed parameters.....	21
13.3.	L Parameters.....	22
14.	Setting the database parameters, tolerances and measurements schemes.....	22
14.1.	Database selection.....	23
14.2.	Reference profile selection and installation.....	24
14.2.1.	Saving reference profiles to a database.....	24
14.3.	Selection and formation of the measurement scheme.....	24
14.3.1.	Selection or removal of the measurement scheme.....	24
14.3.2.	Formation of a new measurement scheme.....	25
14.3.3.	Loading of a new measurement scheme.....	25
14.4.	Tolerances setting.....	26
15.	Version of PDA software.....	27
16.	Shutdown.....	27
17.	Measurements with database maintenance.....	27
17.1.	Measurement.....	28
18.	Browsing the database.....	30
18.1.	Data filtering.....	31
18.2.	Visualization of the disk profile.....	31
19.	Installation of software on PC and startup.....	32
19.1.	Installation.....	32
19.2.	Synchronization of PDA and PC.....	32
19.3.	Program startup.....	33

20.	User settings of the program.....	33
20.1.	Parameters setting.....	33
20.1.1.	"Disk's parameters" tab.....	34
20.1.2.	"Calculated parameters" tab.....	34
20.1.3.	"L-parameters" tab.....	34
20.1.4.	Selection of measurement units.....	34
20.2.	Database settings.....	35
20.2.1.	Setting the path to database.....	35
20.2.2.	Creation of empty database.....	36
20.2.3.	Import of database.....	36
20.2.4.	Language selection.....	36
20.2.4.1.	Preparation and installation of the language support file.....	37
20.3.	Registration data.....	37
20.3.1.	Selection of the organization.....	37
20.3.2.	Registration of operators.....	38
20.3.3.	Registration of series.....	38
20.3.4.	Registration of car/locomotive numbers.....	39
20.3.5.	Registration of tolerances.....	39
20.3.6.	Registration of reference profiles.....	39
20.3.6.1.	Request and registration of the profile file.....	40
21.	Data exchange between PDA and PC.....	41
21.1.	ActiveSync synchronization.....	41
21.1.1.	Transfer of database file to PC.....	41
21.1.2.	Transfer of language file from PC to PDA.....	42
21.1.3.	Transfer of language file from PDA to PC.....	43
21.1.4.	Transfer of reference profile files from PC to PDA.....	43
21.1.5.	Transfer of processing scheme file from PC to PDA.....	44
21.2.	Mass Storage synchronization.....	44
22.	Working with profilograms.....	45
22.1.	Browsing the graph and the profile coordinates.....	45
22.2.	Parameters tab.....	46
22.2.1.	Selection of comparison profile.....	46
22.2.2.	Geometric parameters of the profile.....	46
22.3.	Wear calculation.....	47
22.3.1.	Fast wear calculation.....	47
22.4.	Rescaling.....	47
23.	Scanning and editing of data.....	48
23.1.	Scanning and filtering of data.....	48
23.2.	Editing data.....	49
23.3.	Excel-format report.....	50
24.	Taking measurements under PC control (without PDA).....	51
24.1.	Calibration.....	51
24.1.1.	Installation of Bluetooth-connection.....	52
24.1.2.	Calibration of the profilometer.....	52
25.	Annex 1. Charging procedure.....	53
26.	Annex 2. Program for making measurement schemes.....	53
27.	Annex 3. Testing and calibration.....	54
27.1.	Preparation for testing/calibration.....	55
27.2.	Calibration.....	56
28.	Warranty policy.....	57
29.	List of changes.....	58
30.	Distributors.....	58
31.	RIFTEK's measurement devices for railway transport.....	61

## 1. Safety precautions and measurement conditions

- Prior to mounting the profilometer onto the wheel/disk, areas of contact of the side supports with the wheel/disk surface should be thoroughly cleaned from dirt.
- When mounting the module on the wheel/disk, do not allow heavy shocks of its support against the wheel/disk.
- The output window of the profilometer and profilometer supports must be carefully inspected and cleaned.
- Do not use laser module in locations close to powerful light sources.

## 2. CE compliance

The profilometers have been developed for use in industry and meet the requirements of the following Directives:

- EU directive 2014/30/EU. Electromagnetic compatibility (EMC).
- EU directive 2011/65/EU, "RoHS" category 9.

## 3. Laser safety

The profilometer make use of an c.w. 660 (or 405) nm wavelength semiconductor laser. Maximum output power is 1 mW. The device belongs to the 2 laser safety class according IEC/EN 60825-1:2014. The following warning label is placed on the profilometer body:

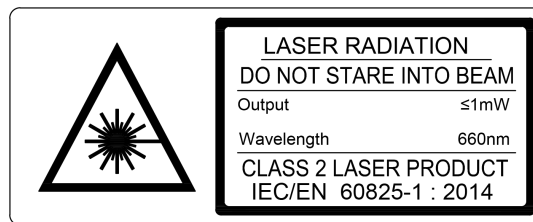

The following safety measures should be taken while operating the profilometer:

- Do not target laser beam to humans;
- Do not disassemble the sensor;
- Avoid staring into the laser beam.

## 4. General information

The Laser disc brakes profilometer IKD Series is designed for:

- measuring the disc brake thickness;
- measuring the disc brake wear;
- measuring the overall thickness of disc brakes;
- full profile scanning and analysis of the working surface of disc brakes;
- support of the electronic database of profiles.

The profilometer can measure parameters of the disc brakes installed on the wheel as well as on the wheelset axle (a removable bracket is used for installation).

## 5. Basic technical data

Name of parameter	Value
Measurement range	30
Profile measurement range, mm	150
Measurement error	± 0.03
Discreteness of indication, mm	0.01
Discreteness of the profile formation, not less, mm	0.1
Digital readout device (PDA) dimensions, mm	see Fig. 3
Dimensions of laser scanning module, mm	see Fig. 5
Power supply (laser scanning module), V	3.7 Li-ion rechargeable battery 6800 mAh
Power supply (PDA), V	3.7 Li-polymer battery 3300 mAh
Number of measurements that can be taken before battery recharge, not less	1000
PDA memory capacity	100 000 measurements
Interface between laser scanning module and PDA	Bluetooth
Operating temperature, °C	-15...+35
Enclosure rating	IP42

## 6. Example of designation when ordering

**IKD - universal** – Profilometer designed to measure parameters of the disc brakes installed on the wheel and on the wheelset axle. The set includes a removable bracket used to install the profilometer on the disc brakes installed on the wheelset axle.

## 7. Complete set to be supplied

Designation	Name	Quantity	Weight, kg
RF303M	Digital readout device (PDA)	1	0.3
RF506	Laser scanning module	1	3
RF506.51.008	Removable bracket	1	1.2
RF506.40	Charging device 5V 1A for PDA	1	0.2
RF506.41	Charging device 5V 1A for laser module	1	0.2
RF506.42	Data cable	1	
RF506.43	Bluetooth adapter	1	
RF506.30	Packing case	1	1.2
IKD_DB	Database management system (CD)	1	
RF506UM	User's manual	1	
	Calibration tools (option):		
RF506.51.000	Calibration block for disk brakes installed on the wheel		5.4
RF506.41.000-01	Calibration block for disk brakes installed on the wheelset axle		5.7
RF506Calibr	Calibration software		

The profilometer comes in the special case that protects the device against any possible damage (Figure 1).



Figure 1

## 8. Device structure

### 8.1. Basic components of the device and their functions

Basic components of the device (Figure 2):



Figure 2

- (1) Digital readout device (personal digital assistant, PDA)
- (2) Laser scanning module
- (3-4) Charging devices
- (5) Data cable

### 8.1.1. Digital readout device

Digital readout device (PDA) is designed for control of the laser scanning module, data reception from the scanning module, indication of measurement results, parameter input, and data storage.

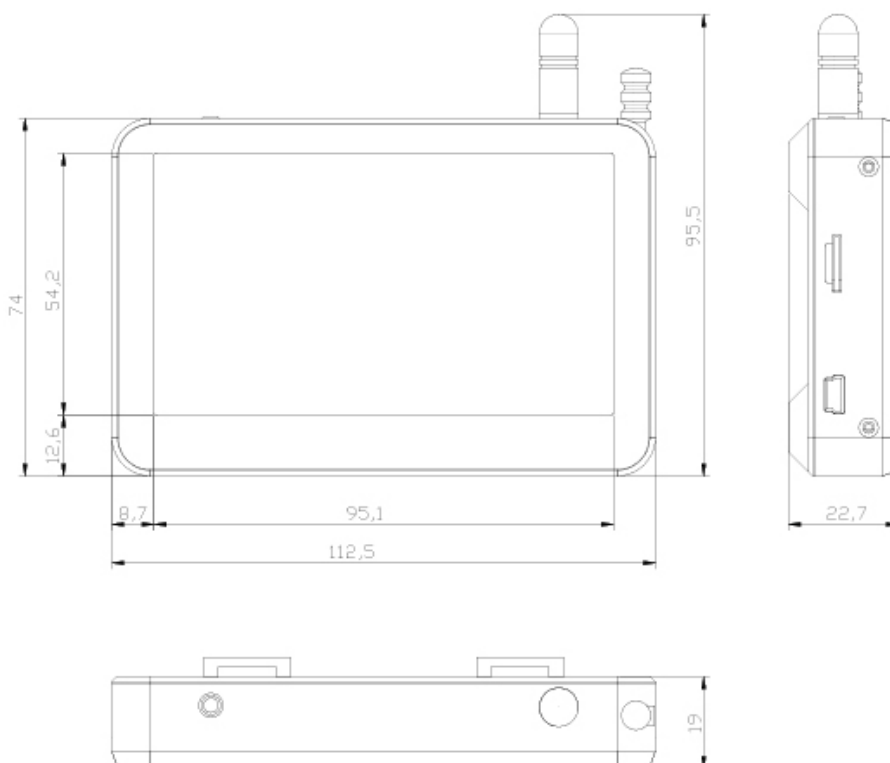

**Figure 3**

Figure 3 indicates:

- (1) Turn-on button
- (2) Charging indication, red/blue LED
- (3) Connector to PC USB-port or charging device
- (4) Flash memory card connector
- (5) Stylus
- (6) Bluetooth antenna

Overall dimensions of PDA are shown in Figure 4:



**Figure 4**

### 8.1.2. Laser scanning module

The module is intended for laser scanning of the disc brakes surface.

Figure 5 indicates:

- (1) Turn ON button
- (2) Indicator of Bluetooth connection (blue LED)
- (3) Indicator of turn ON (red LED)
- (4) Charging device connector
- (5) Charging indication, red/green LED
- (6) Magnetic support for mounting on the wheel side surface
- (7) Output window
- (8) Removable bracket

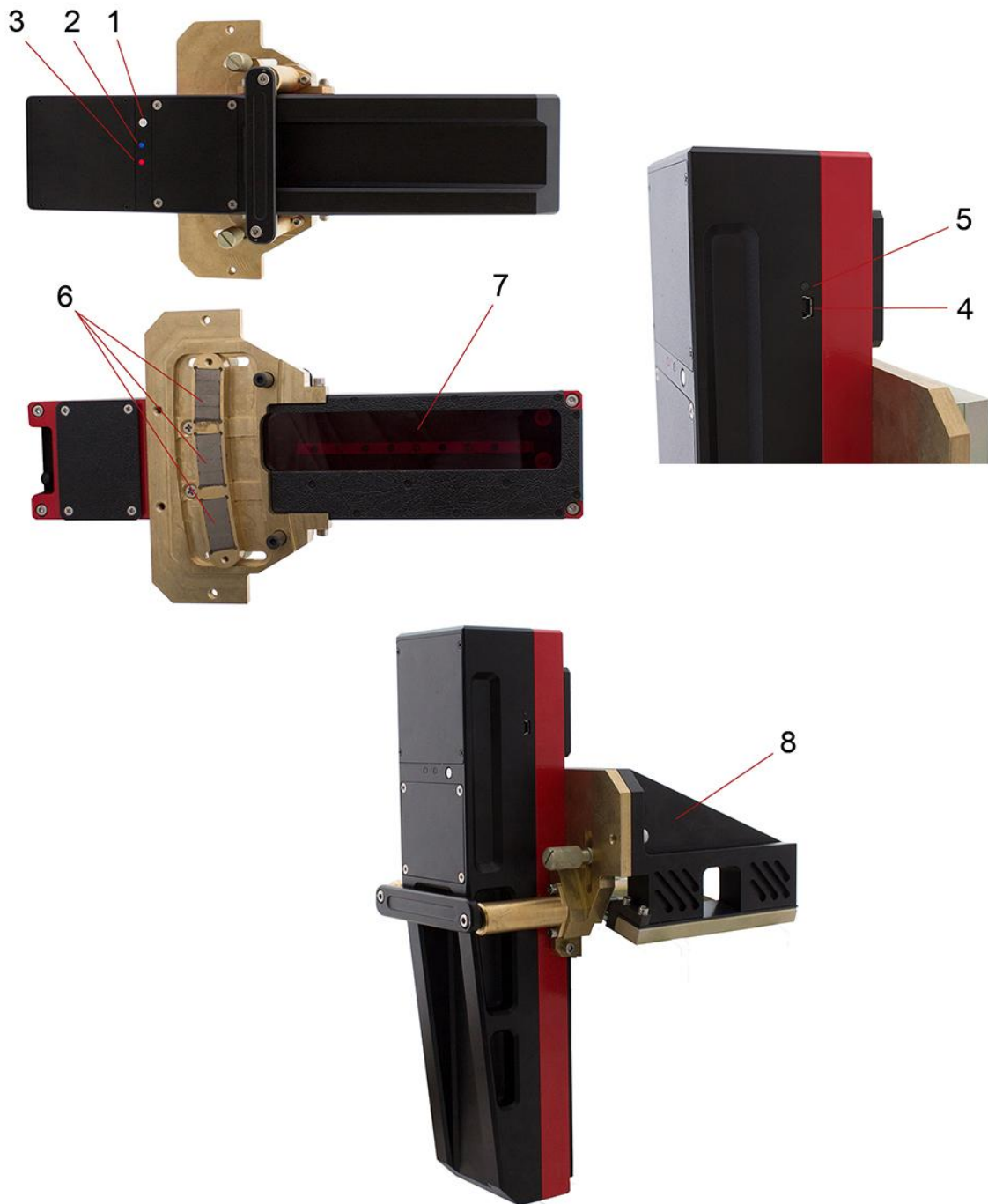

Figure 5



Overall dimensions of the scanning module for the disc brakes installed on the wheel are shown in Figure 6:

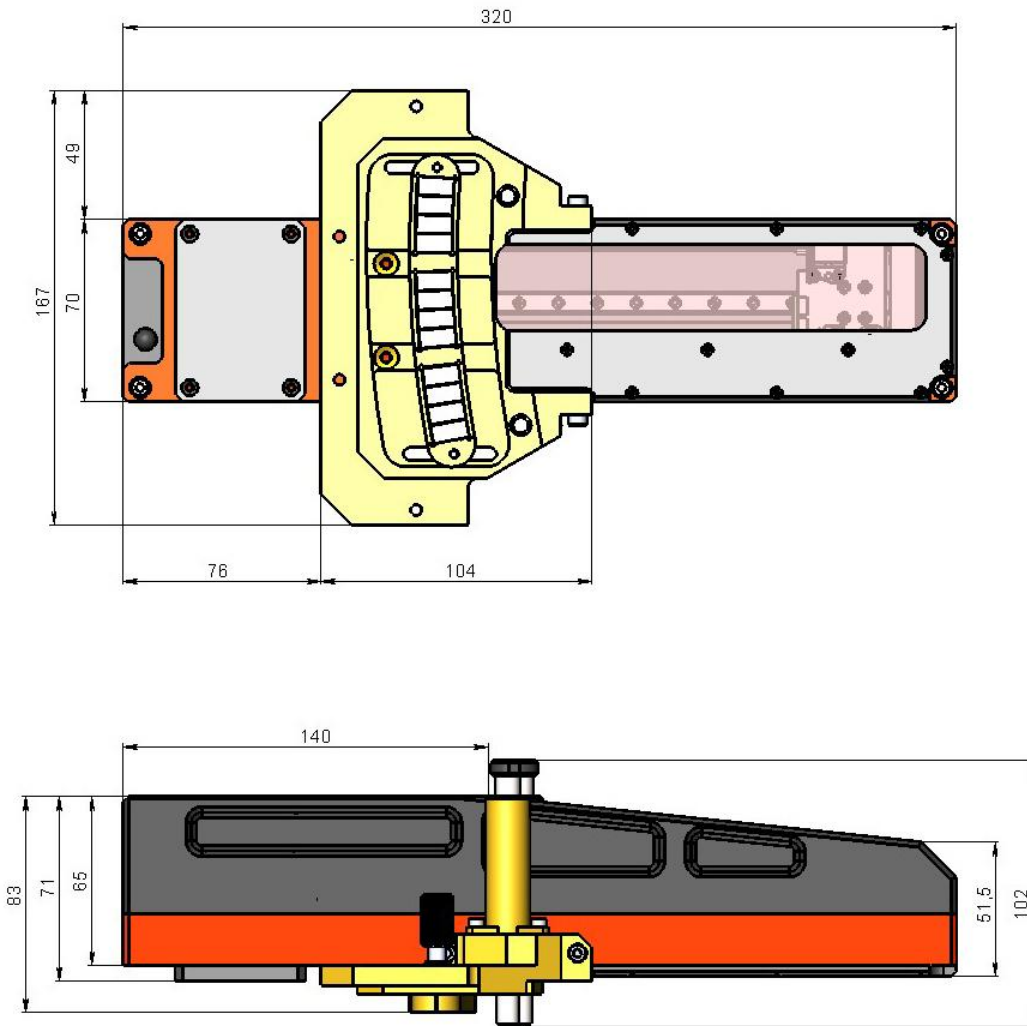

Figure 6

Example of mounting the IKD onto the disc brakes (Figure 7):

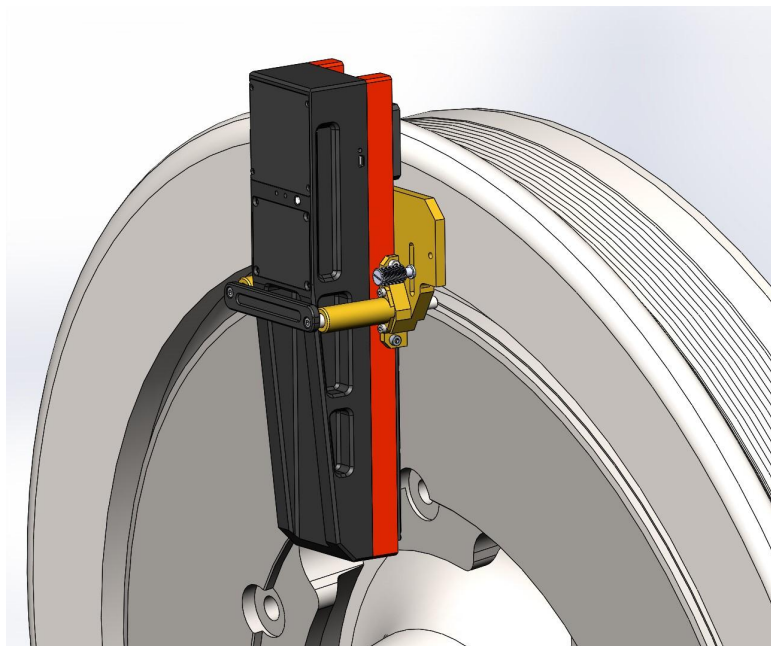
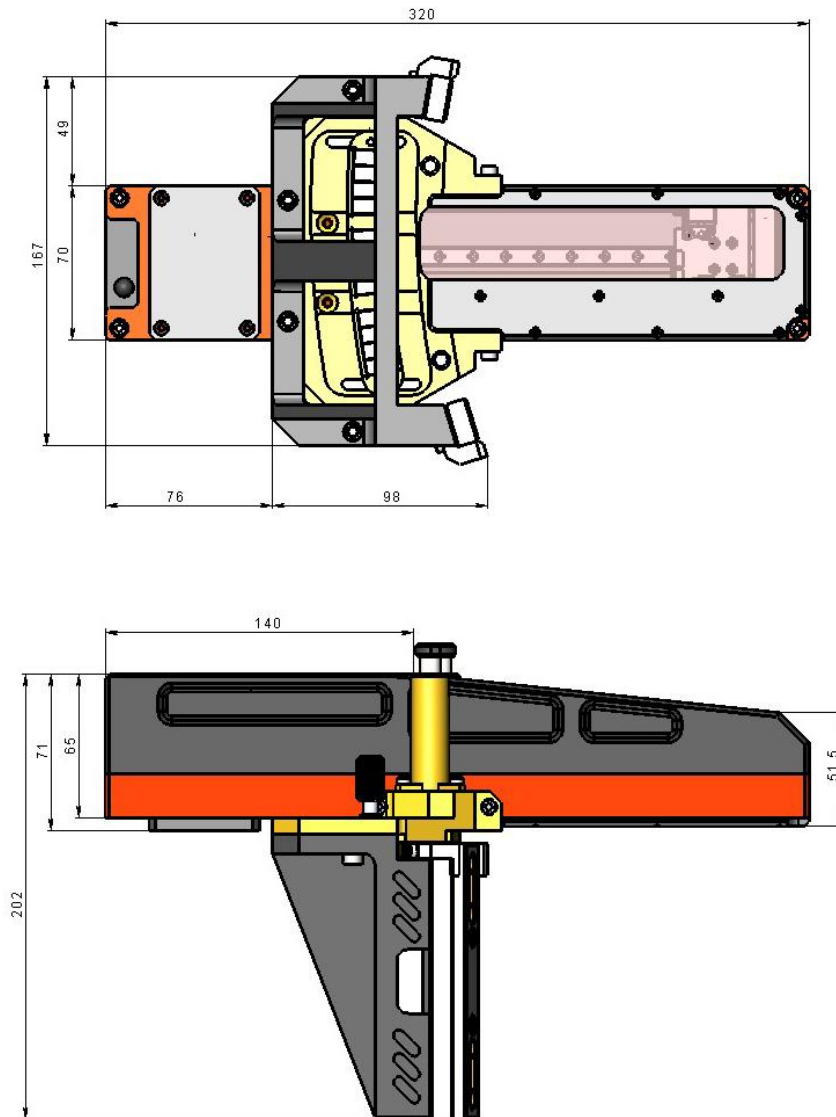

Figure 7

Overall dimensions of the scanning module for the disc brakes installed on the wheelset axle are shown in Figure 8:



**Figure 8**

Example of mounting the IKD onto the disc brakes installed on the wheelset axle (Figure 9):

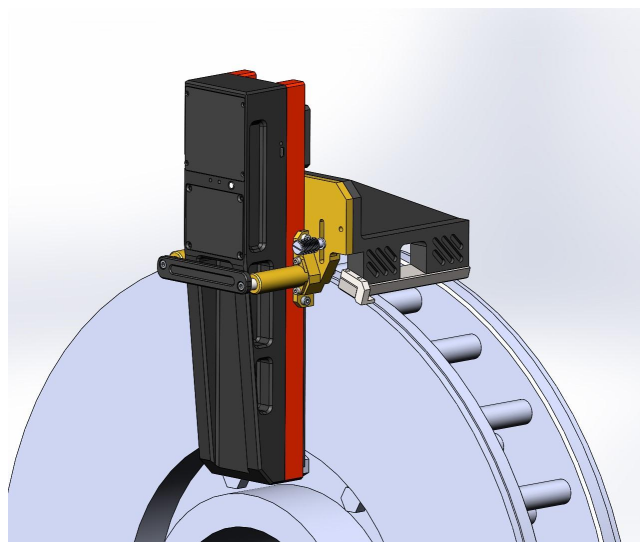

**Figure 9**

### 8.1.3. Removable bracket installation

IKD without a removable bracket is used for the disc brakes installed on the wheel (Wheel-mounted).

To measure the disc brakes installed on the wheelset axle, the profilometer comes with a removable bracket (RF506.51.008).

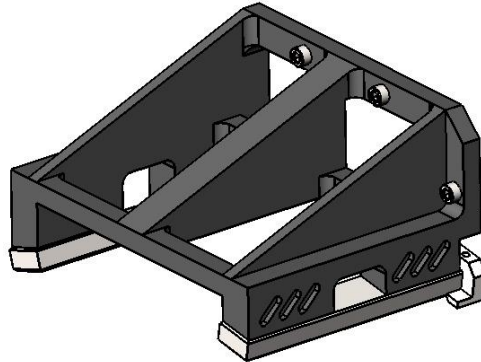

Figure 10

The bracket is fastened to the IKD support using 4 screws.

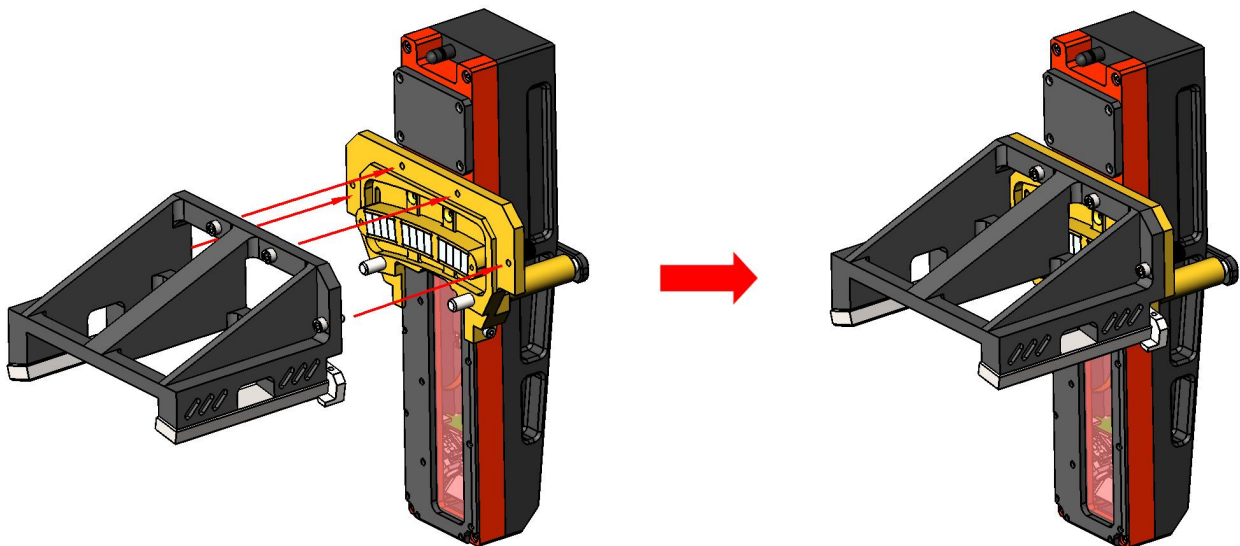

Figure 11



**Attention!**

After installing or removing the bracket (RF506.51.008), it is necessary to calibrate the profilometer on the supplied calibration block before starting to measure the disk brakes!

## 8.2. Calibration blocks

The profilometer can come with the calibration blocks of two types:

- calibration block for the disk brakes installed on the wheel,
- calibration block for the disk brakes installed on the wheelset axle.

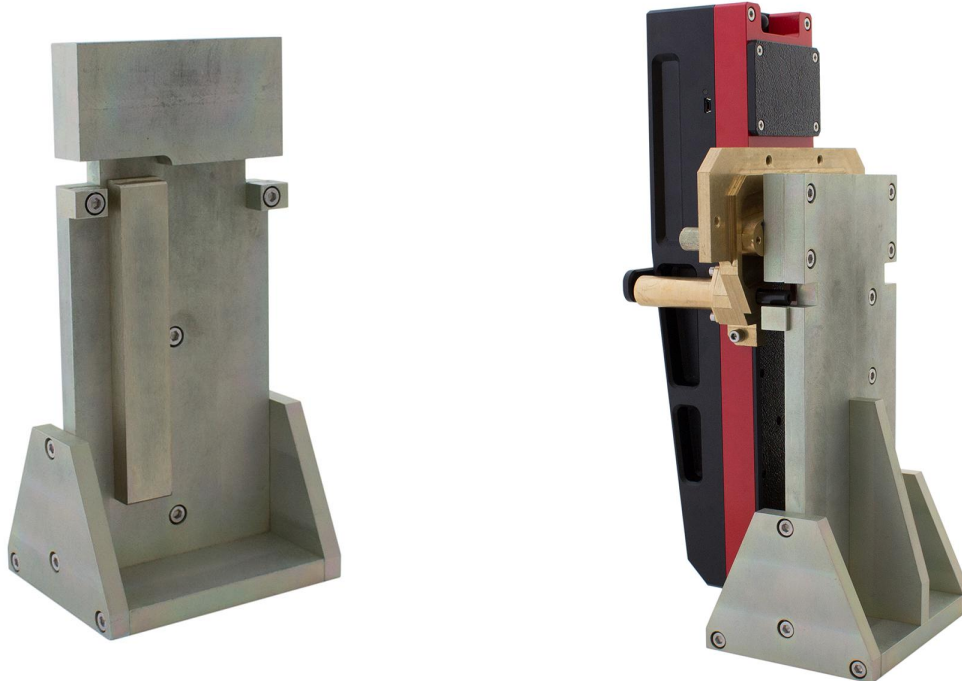

Figure 12. Calibration block RF506.51.000

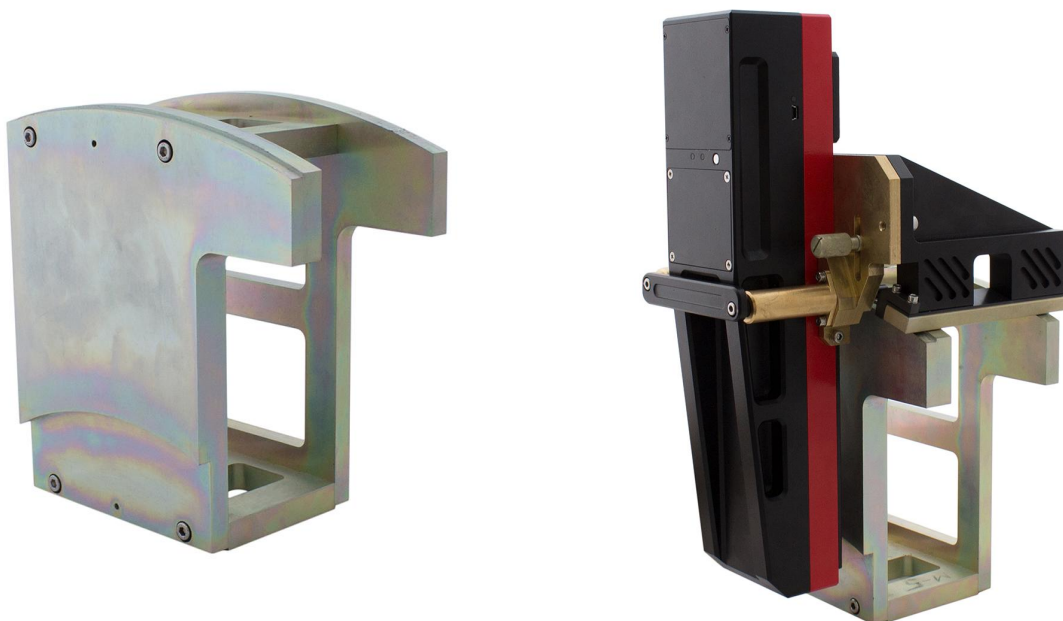

Figure 13. Calibration block RF506.41.000-01

## 9. Operation principle

Operator mounts the laser scanning module onto the disk to be measured. Having received a command from PDA or PC, the laser module performs non-contact scanning of the disk surface. Measurement results (geometric parameters and profile of the surface) are displayed on PDA, can be saved in the PDA memory, and transferred to the PC database. Simultaneously, additional parameters can be saved: operator number, side identifier (left or right wheel), axis number, locomotive (carriage) number, etc.

## 10. Geometric parameters of the brake disc under control

Brake disk parameters are calculated automatically after laser scanning. Parameter L1 is used to calculate the overall thickness of the brake disc. The default value of parameter L1, set in the PDA, is given in p. [13.3](#). and can be changed by the user.

### 10.1. Brake disc thickness

Calculation of the brake disc thickness.

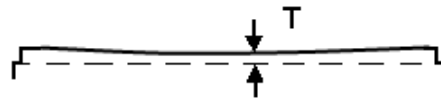

### 10.2. Brake disc wear

Calculation of the brake disc wear in relation to the reference profile.

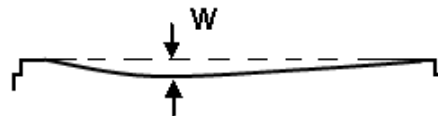

### 10.3. Overall brake disc thickness

Calculation of the brake disc thickness.

Calculation of the minimum value of the brake disc thickness for both sides. Two profiles must be measured:

$$D = T1 + T2 + L1$$

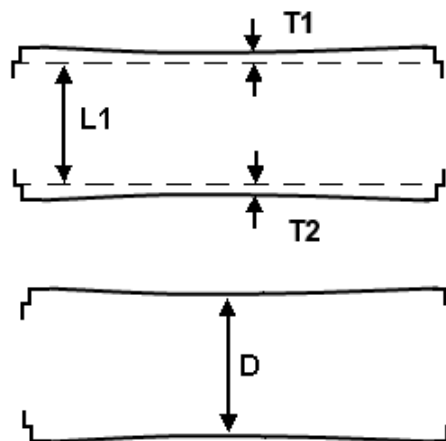

## 11. First activation and measurement procedure

Charge accumulators of the laser module and indication device by connecting them to charging devices (see par. 25).

### 11.1. Activation

- Turn the PDA on by pressing the button (1), Figure 3. The PDA screen will show the main program window containing: main menu; indicators of PDA and laser module charging degree; indicator of Bluetooth connection.

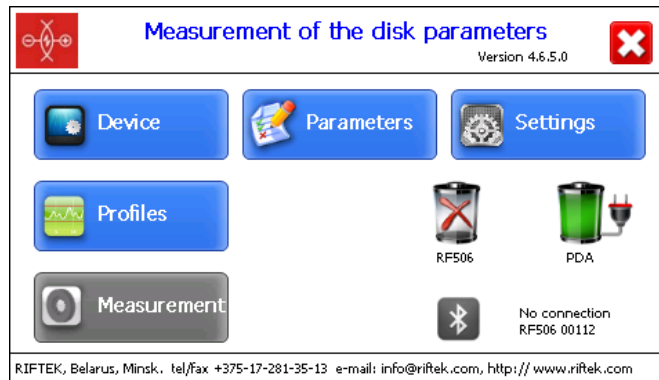

Button	Assignment
Device	Setting the PDA basic parameters (p.12)
Parameters	Setting the measurement parameters (p.13)
Settings	Setting parameters of database, tolerances, and others (p.14)
Profiles	View the disk profile (p.18)
Measurement	Run the measurement process (p.11.2)

- Switch the laser module on by pressing and holding button 1 (Fig. 5) for several seconds. When connecting the laser module, a red LED blinks (3).
- After the laser module is switched on, some time will pass until automatic wireless communication is set between the profilometer and the PDA, which is accompanied by blinking of a blue LED (2) on the laser module. The LED goes out when the link is established.
- The main program window will be updated.

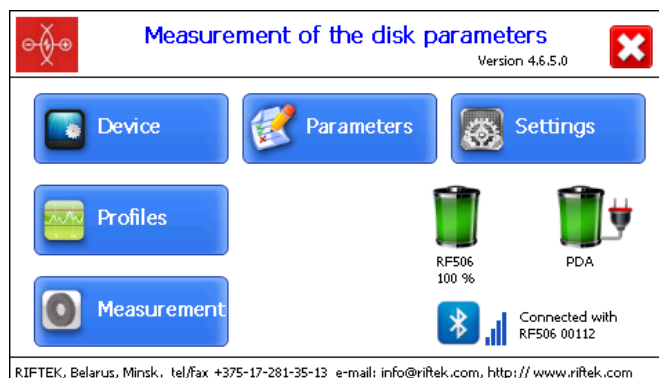

The **Measurement** button, indicator of Bluetooth connection, serial number of the laser scanning module, and indicators of the charging degree will be active.



## 11.2. Measurement

There are two types of measurements:

1. Rapid measurements without saving the results.
2. Measurements by using the selected scheme with saving results to database.

The measurement procedure by using type 2 is described in par. [17](#). How to select the measurement type see in par. [12.1](#).

Measurement by using the scheme (type 2) is used for full-featured work with the profilometer with maintaining the database of measurements.



### Attention!

Before installing the scanning module onto the disk you need to clean of dirt the areas, where the basic supports of the laser scanning module contact with the disk surface.



When installing the laser scanning module onto the disk avoid of strong impacts of its supports on the disk, because it can lead to incorrect operation of the profilometer.

15

## WARNING!

To avoid device shock on the wheel refer to the following installation procedure:

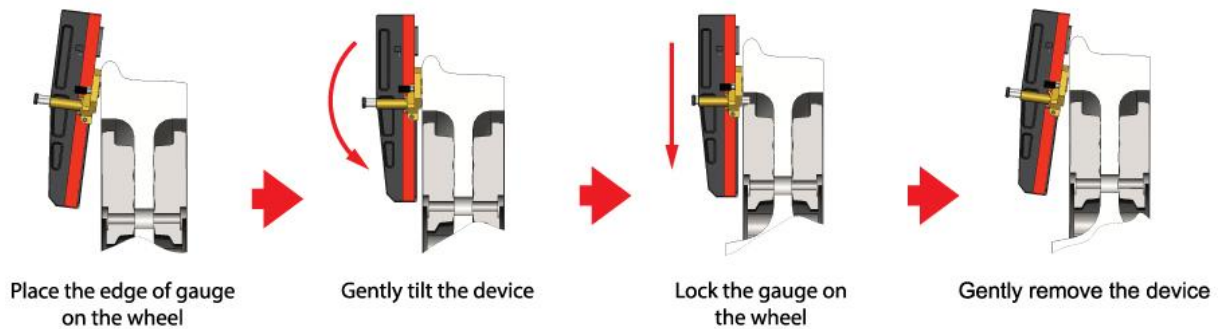

You need to inspect periodically the output window and basic supports of the laser scanning module and clean them of dirt.

Do not clean the glass by using abrasive materials and aggressive cleaning agents.

To perform single measurement, it is necessary to:

- Fix the laser module on the calibration unit or disk.



Figure 14A

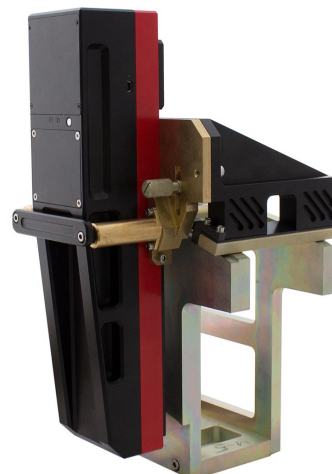
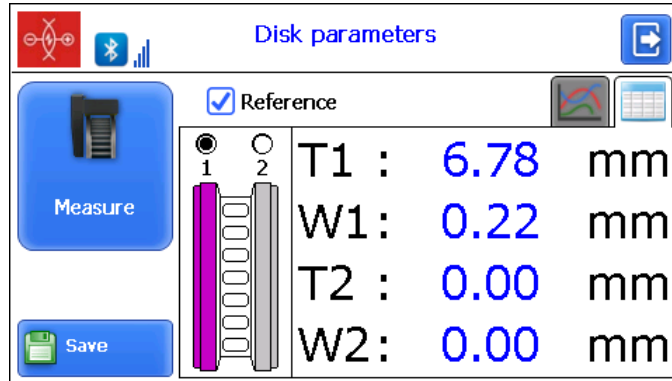
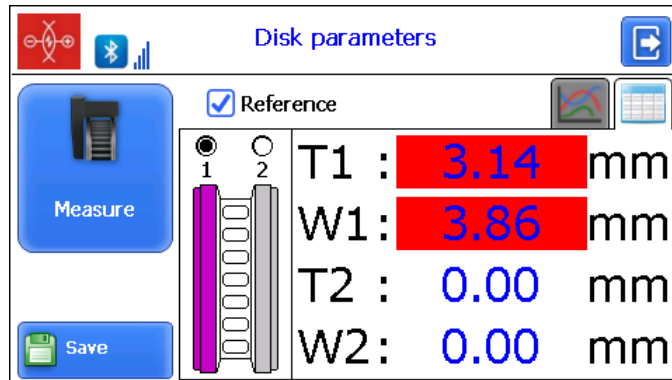

Figure 14B

- Make sure that the module is mounted correctly without any misalignment and gaps.
- Tap the **Measurement** button on the PDA display.
- The laser module is scanning the disk surface. During the scanning process (3-4 seconds), a red LED (3) is lit.
- When the scanning process is complete, the PDA will show the values of measured parameters selected for displaying (see par. [13.2.](#)).



When the parameter goes beyond the set limits, its value is highlighted in red:



- To view the disk profile, tap the **Profile** button:

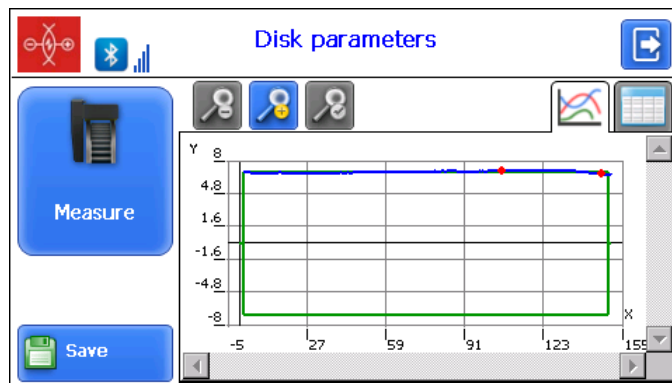

- If you scan the calibration block or the reference disk and scanning results differ from the reference values by no more than 0.1 mm, the device is ready to work, otherwise it must be calibrated in accordance with par. [24.1.2.](#) or [27.2.](#)

## 12. PDA basic parameters setting

Prior to starting work with the profilometer, PDA program setting must be performed.

The window of basic parameters setting is called by clicking the **Device** button in the main program window (par. [11.1.](#)):



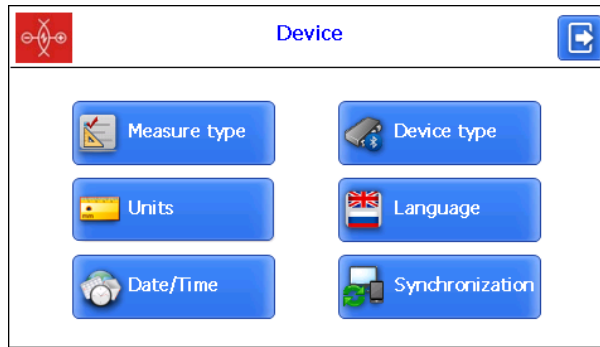

Button	Assignment
Measure type	Rapid measurements/measurements with saving results to database
Units of measurement	Millimeters/inches
Date/time	Date/time setting
Device type	Device selection
Language	Language selection
Synchronization	Synchronization with PC

### 12.1. Measurement type

There are two types of measurements:

1. Rapid measurements without saving the results.
2. Measurements by using the selected scheme with saving results to database.

To select the measurement type, tap the **Measure type** button. Then select **Rapid measurement** or **Measurement by scheme**. Tap the **Save** button.

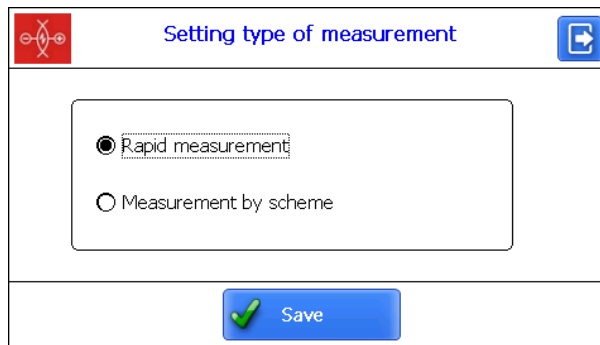

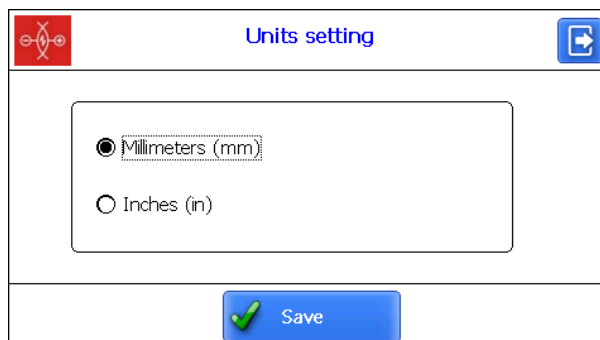

### 12.2. Units of measurement

All parameters and measurement results can be present in the Metric system (millimeters), or in the English system (inches). To set the units of measurement, tap the **Units** button. Next, select **Millimeters (mm)** or **Inches (in)**, and tap **Save**.



### 12.3. Date/time setting

To set the date and time, tap the **Date/Time** button. Next, set the date and time using the buttons  , and tap the **Save** button.

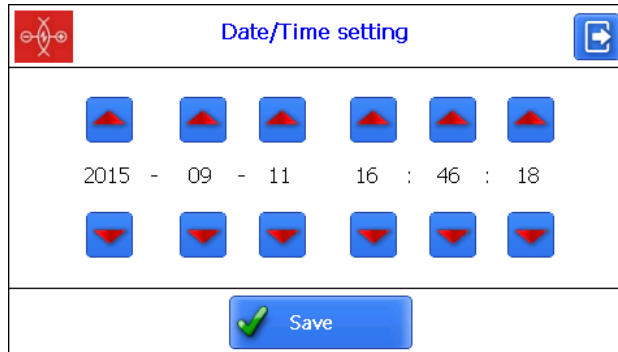

### 12.4. Device selection

The PDA Bluetooth-connection is automatically configured to work with the laser scanning module, which comes with the PDA.

To **Select/Add** other device, tap the **Device type** button.

The device selection window contains a list of available devices (devices, the connection with which has been established earlier, and which have been saved in the PDA memory).

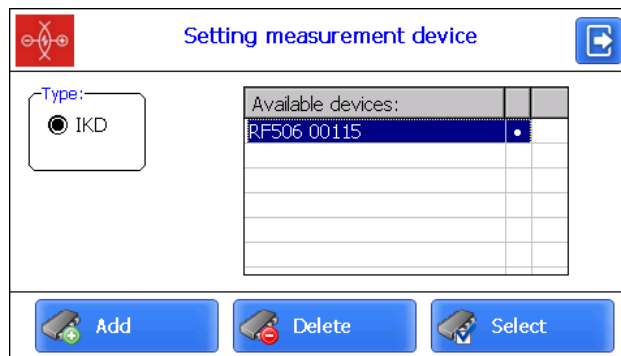

If the device that you need is present in the list, you can select it and tap the **Select** button. From now on, the PDA will attempt to connect to the selected device by default.

If the device number is absent in the list, you can add it. Tap the **Add** button and go to the **Device searching** window.



To search for available devices, tap the **Start** button and wait for the search to complete:

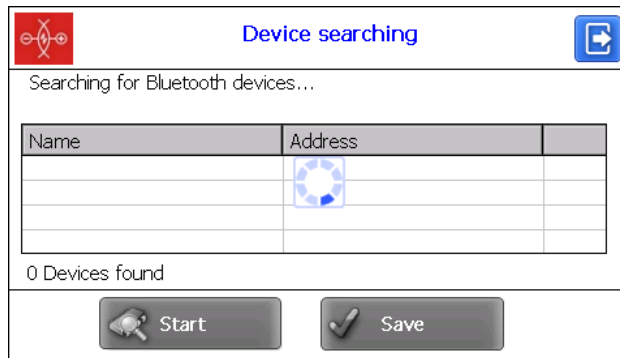

Detected devices (with serial numbers) will appear on the screen:



Next, select the device and tap the **Save** button to save the address of the new device.

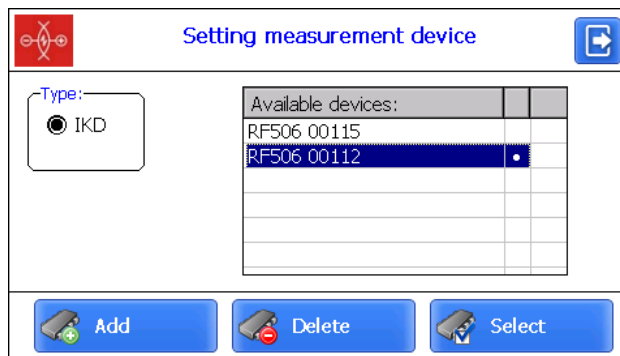

You can delete the device that you do not use anymore by tapping the **Delete** button.



## 12.5. Language setting

It is possible for the user to change the program language, form his own language support files as well as change/edit the terminology used.

To select the language, tap the **Language** button. Next, select the required language support file and tap the **Select** button.

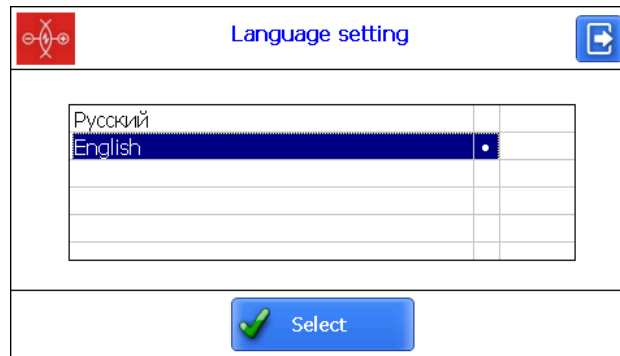

If no such file is available, it is necessary to use the new files preparation procedure, which is described in par. [20.2.4.1.](#), and then load a new language file from PC to PDA as shown in par. [21.1.3.](#)

20

## 12.6. Synchronization with PC

To transfer data between PDA and PC, it is necessary to synchronize them. There are two ways of synchronization via USB cable.

When you select **MS ActiveSync**, synchronization with PC is performed via the **ActiveSync** software (Windows XP), or via **Windows Mobile Device Center** (Windows 7). When you select **Mass Storage**, the device is detected in Windows as an external storage device.

To select the type of synchronization, tap the **Synchronization** button in the **Device** window. Next, select the required type and tap **Save**.

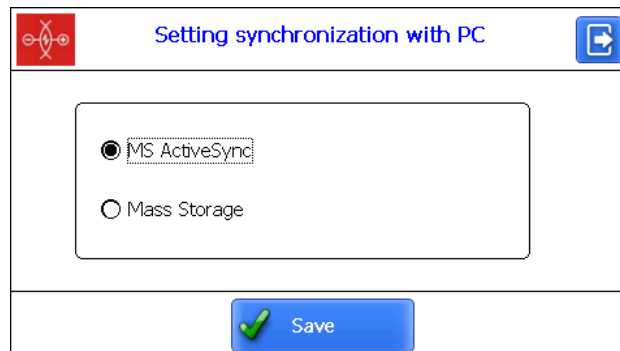

To apply the changes, PDA will prompt you to restart. If you do not need to sync the PDA with PC currently, you can restart the PDA later.

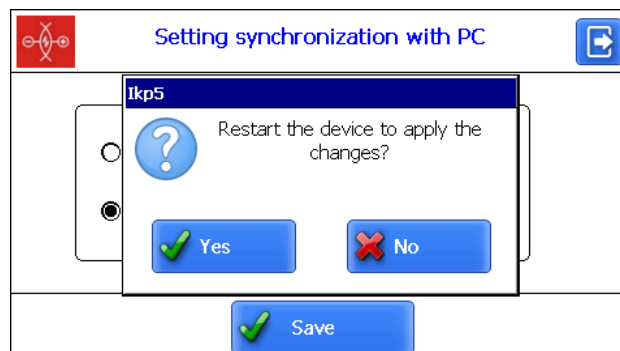

## 13. Calculation settings

The **Parameters** window, which is called from the main program window, is intended for calculation settings of controlled parameters of the disk.

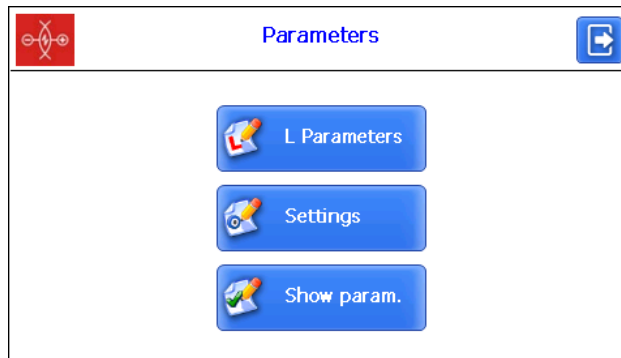

Button	Assignment
Settings	Calculation methods setting
Show param.	Selection of displayed parameters
L Parameters	L Parameters setting

### 13.1. Calculation methods

To select the calculation method, tap the **Settings** button. The following window appears:

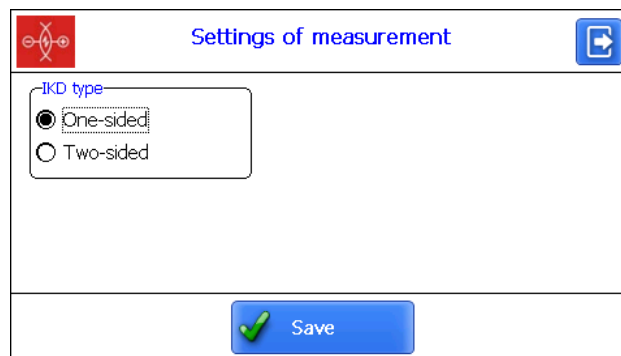

Select the method and tap **Save**.

### 13.2. Selection of displayed parameters

Tap the **Show param.** button. The following window appears:

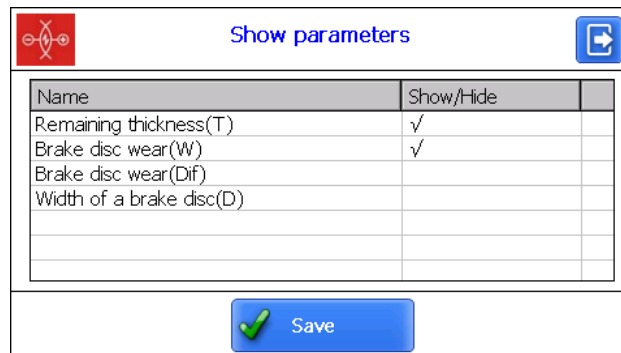

To select/deselect the parameter to display, double-click in the **Show/Hide** column opposite to the required parameter. Tap **Save**.

### 13.3. L Parameters

To set L-parameters, tap the **L Parameters** button.

The program displays only those parameters, which are necessary to calculate the selected geometrical parameters of the disk.

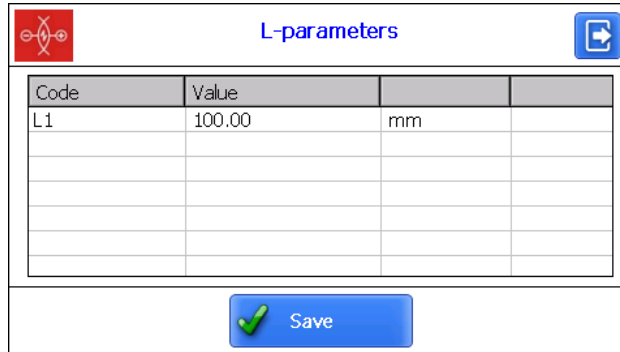

Code	Value		
L1	100.00	mm	

L-parameter	Default value	Assignment
L1	100 mm	Used for calculation of the disk thickness (par. 10)

To edit the parameter, tap twice in the **Value** column opposite to the required parameter, and enter a new value in the **Data Input** window. Then tap the **Enter** button -

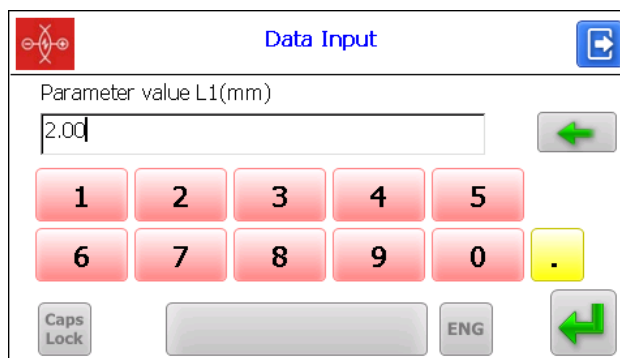
Tap the **Save** button to save changes.

## 14. Setting the database parameters, tolerances and measurements schemes

The **Settings** window is intended for setting the database parameters, tolerances, measurements schemes, etc.

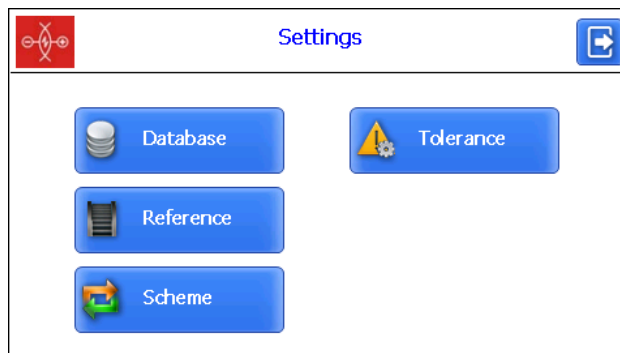

Button	Assignment
Database	Selection of the current database
Reference	Reference profile selection
Scheme	Measurement scheme setting
Tolerance	Tolerances setting

### 14.1. Database selection

If necessary, the measurement results can be saved to the PDA database. The program makes it possible to create and store several database files connected with a specific date of taking measurements.

To select the database file, tap the **Database** button.

23

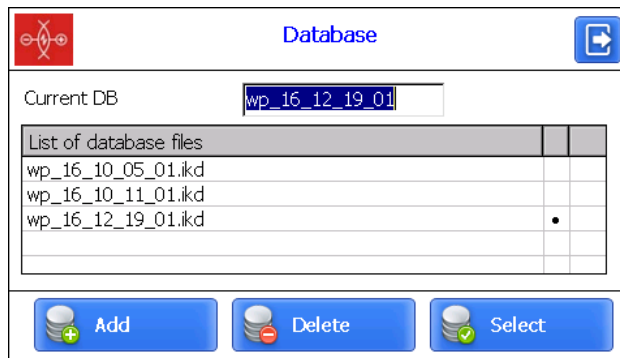

To create a new database, tap the **Add** button.

By default, the program prompts to form the database file with the name **wp\_yy\_mm\_dd.ikd**, where **yy\_mm\_dd** is the current date:

**yy** – the last two digits of the year;

**mm** – month;

**dd** – day.

You can agree with the proposed name, or enter another:

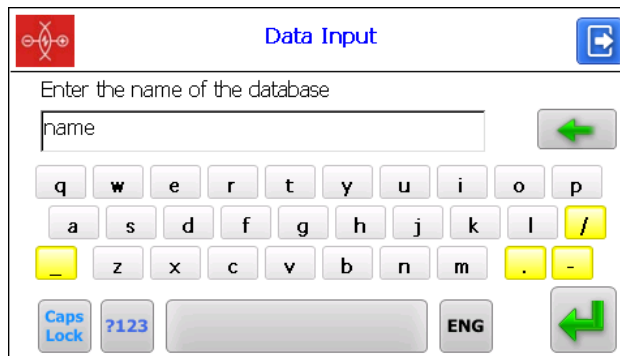

Then tap the **Enter** button - .

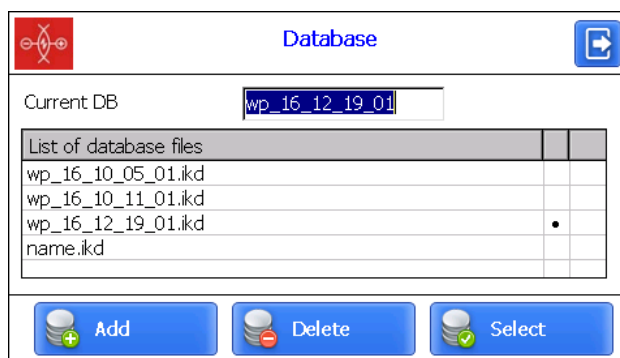

To select the database file from a list of previously created, tap it and then tap **Select**. The selected file will be marked with "•".

To delete the database file, tap it and then tap **Delete**. If you delete the current database, the error message will appear.

## 14.2. Reference profile selection and installation

The program makes it possible to compare the scanned profile of the disk with the reference profile. To select the reference profile, tap the **Reference** button.

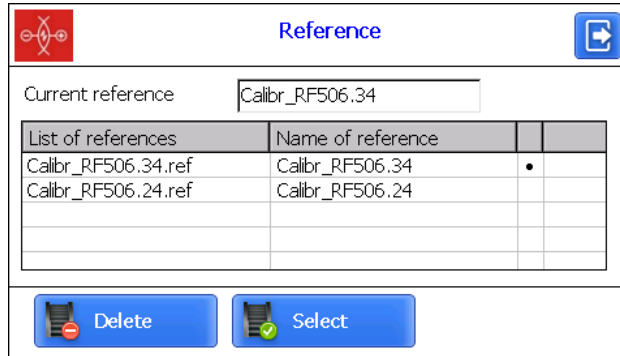

To select the reference file, tap on it and then tap **Select**. The selected file will be marked with "•".

To delete the reference file, tap on it and then tap **Delete**. If you delete the current reference file, the error message will appear.

### 14.2.1. Saving reference profiles to a database

Reference profiles are stored in the PDA database as profile description files with the extension **.ref**. The PDA is supplied with several pre-installed profiles.

If there is no required reference profile in the database, the user can request the missing profile from **RIFTEK** (free), and then transfer the received profile to the PDA as shown in par. [21.1.4.](#)

## 14.3. Selection and formation of the measurement scheme

Measurement scheme is meant as a sequence of making measurements/processing of wheels in the rolling stock with specified parameters of each wheelset (wheelset numbers, car numbers, series, etc.). The program automatically offers operator to perform measurement on a concrete wheel in accordance with selected scheme of wheel processing. The program contains several preset schemes. Besides, the user can form his own measurement scheme.

### 14.3.1. Selection or removal of the measurement scheme

To select the measurement scheme, tap the **Scheme** button.

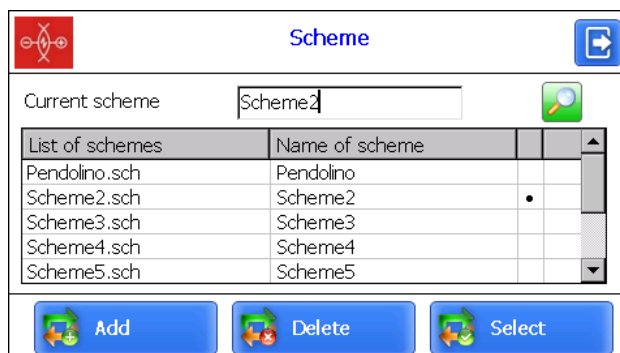



To view the scheme, tap the line containing the scheme file name, and then tap the **View** button .

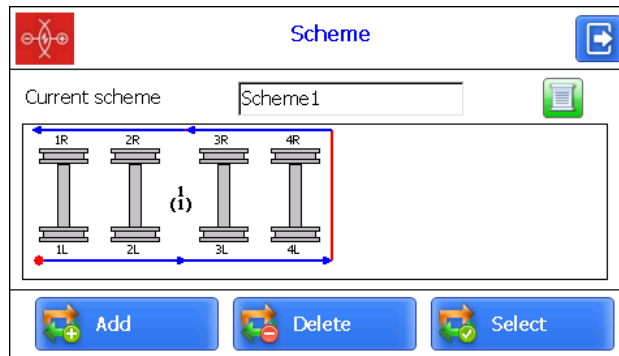

Arrows in the figure show the direction of processing of brake disks as well as the names assigned to disks (1L-first axis, left side; 2L-second axis, left side; 1R-first axis, right side, etc.).

To select the scheme file, tap it and click **Select**. The selected file will be marked with "•".

To delete the scheme file, tap it and click **Delete**. If you delete the current scheme, the error message will appear.

#### 14.3.2. Formation of a new measurement scheme

To form a new measurement scheme, tap **Add**. By using the on-screen keyboard, type the scheme name, or agree with the proposed name. Then tap the **Enter** button - .

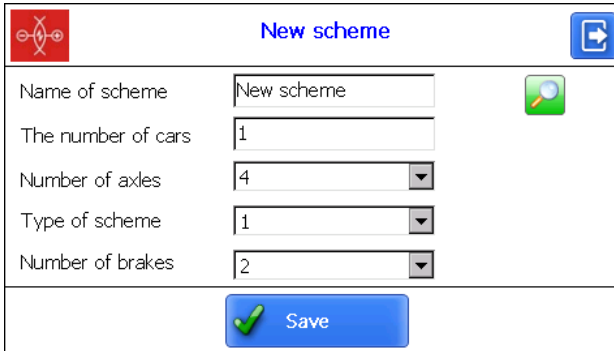

Next:

- select the number of cars in the rolling stock;
- select the number of axes;
- select the scheme;
- select the number of disk brakes;
- tap **Save**.

During the selection of parameters **Number of axes** and **Type of scheme**, you can look at the formed scheme by using the **View** button - .

This method of creating the measurement scheme makes it possible to create only simple schemes without specifying the numbers of wheelsets, cars, etc. To form a complete scheme, see par. [26](#).

#### 14.3.3. Loading of a new measurement scheme

If you can not create a new scheme as described in the previous paragraph, you can use the special program for PC (see par. [26](#)), and then upload that scheme to the PDA as described in par. [21.1.5](#).

## 14.4. Tolerances setting

The program automatically controls measured geometric parameters for going out beyond the tolerances set. It is possible for the user to create groups of tolerances. Control of parameters will be performed for a selected group.

To select the current group of tolerances, tap the **Tolerance** button.

The table will show the tolerances only for the selected geometric parameters of the disk.

A red color indicates the maximum/minimum critical values of parameters. An orange color indicates the maximum/minimum values, which are close to critical values.

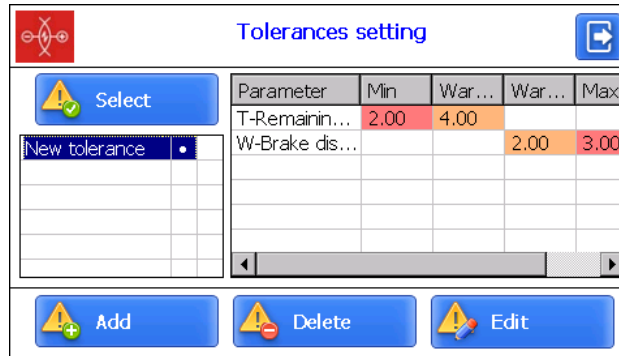

Parameter	Min	War...	War...	Max
T-Remainin...	2.00	4.00		
W-Brake dis...			2.00	3.00

To select the group of tolerances, tap it and then tap **Select**. The selected file will be marked with "•".

To delete the tolerance, tap it and then tap **Delete**. If you delete the current tolerance, the error message will appear.

To correct the tolerance, tap it and then tap **Edit**.

To add a new tolerance, tap the line with the type name and then tap **Add**. View on the screen:



Parameter	Min	War.Min	War....	Max	
T-Remainin...	0.00	0.00			mm
W-Brake dis...			0.00	0.00	mm

To change the type name, it is necessary to place a cursor in the **Name of Tolerance** field, and enter a new value in the appeared window. Then tap the **Enter** button -



To correct the value, it is necessary to tap twice in the column opposite to the parameter name, and enter a new value in the emerged window. Then tap the **Enter** button. If any of the parameters has a zero value, the tolerance will not be used.

After setting the tolerances, tap **Save**.

## 15. Version of PDA software

The software version is shown in the main program window:

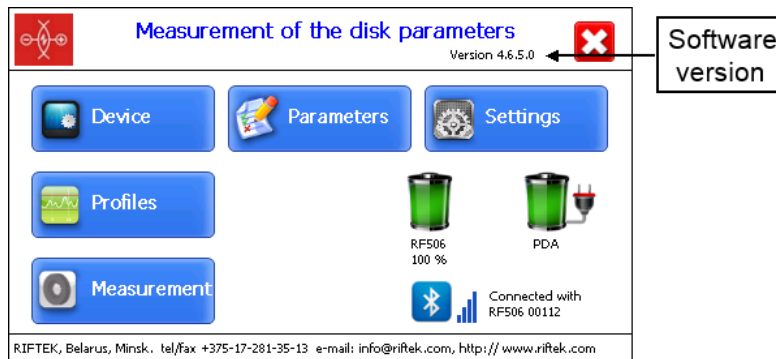

## 16. Shutdown

To shutdown the PDA, tap the **Shutdown** button - , and confirm the action:

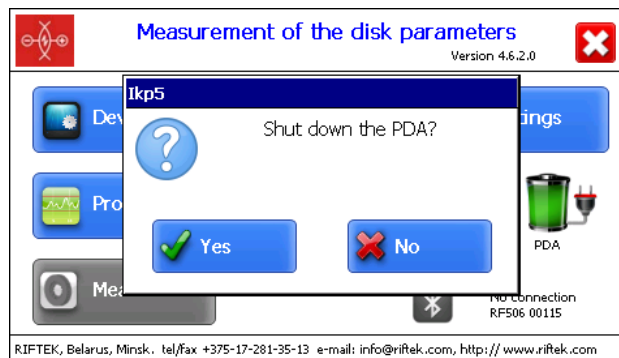

## 17. Measurements with database maintenance

There are two types of measurements:

1. Rapid measurements without saving the results.

2. Measurements by using the selected scheme with saving results to the database.

Procedure of rapid measurements is described in par. [11.1](#). How to select the measurement type, see par. [12.1](#)

The second type is used for a fully functional work with the profilometer with saving results to the database.







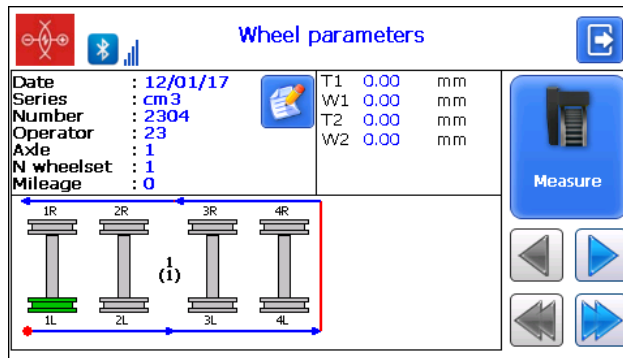

When the Bluetooth-connection is established, you can start measurements by using the **Measurement** button in the main program window. The window for entering the wheelset parameters will appear on the screen:



Parameter fields will be filled in accordance with the selected measurement scheme. If needed, you can fill/edit the required fields, and tap the **Save** button to save changes. The selected scheme will be displayed on the screen:



### Designations and buttons:

	ordinal number of the car to be measured (number of cars in the train)
	editing of the wheel parameters
	a previous/subsequent disk
	a previous/subsequent car
	a measured disk
	a disk to be measured next time
	a non-measured disk
	a measured disk to be measured again
	measurement

## 17.1. Measurement

- Measure the brake disk offered by the program (highlighted in green). To do this, tap the **Measure** button. The laser module will scan the selected side of the brake disc.
- Upon completion of the scanning process, the measured values of geometrical parameters selected for displaying will appear on the PDA screen.

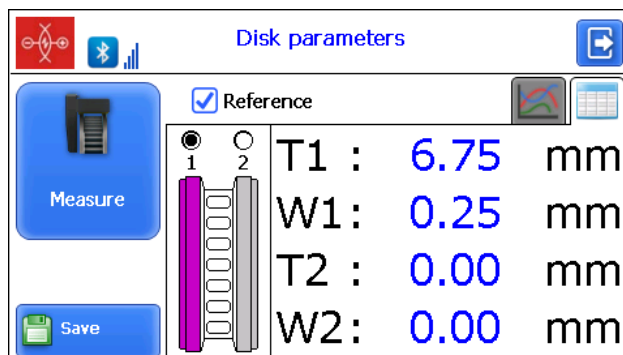

The values, which are beyond the tolerances, will be highlighted in red:

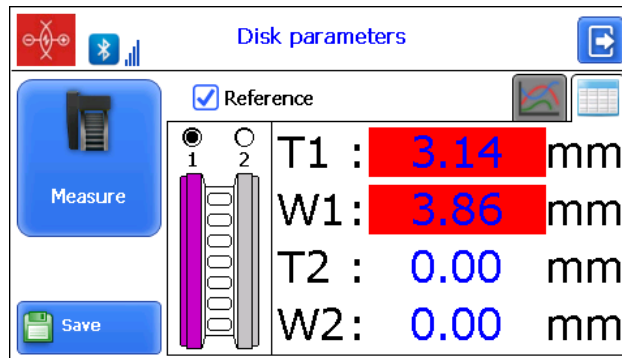

- To view the disk profile, tap the **View** button - . The scanned disk profile and the selected reference profile will be displayed on the PDA screen.

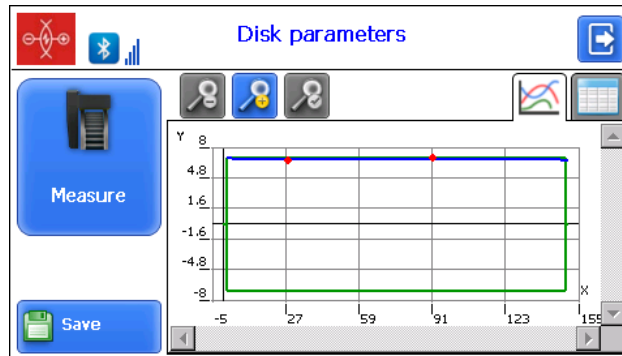

For more information about working with profiles, see par. [18.2](#).

- To perform the measurement again, tap the **Measure** button.
- Next, it is necessary to perform the measurement of the other side of the brake disc:
  - Install IKD on the other side of the brake disc
  - Select the disc you need

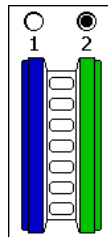

- Perform the measurement

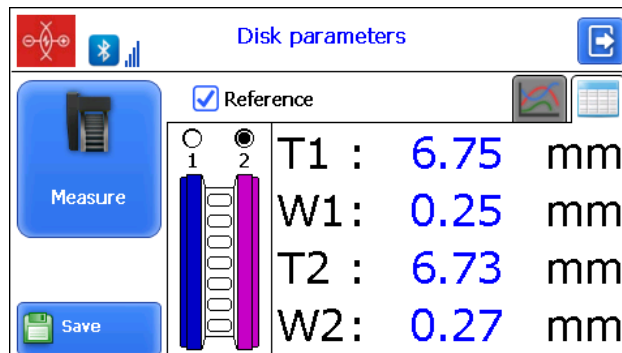

- When a satisfactory result is obtained, tap the **Save** button to save it.
- The program will offer to pass to the measurement of the next brake disk in accordance with the selected measurement scheme.

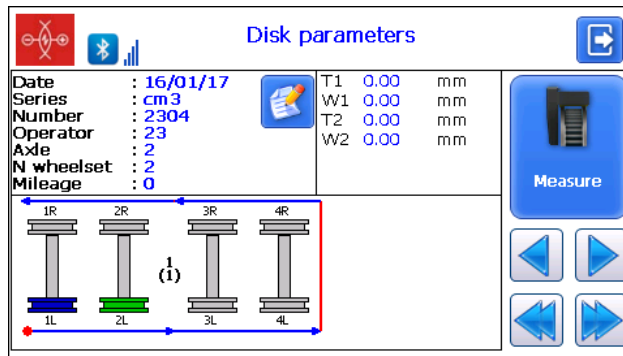

- To view the results of previous measurements, you can use the arrows. If you select the measured disk, the saved parameters of the disk will be displayed on the PDA screen.

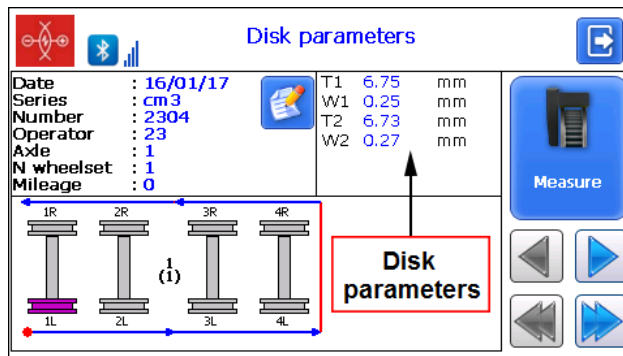

- When you measure the brake disk that was previously measured, the program prompts you to replace the existed database file with a new one.

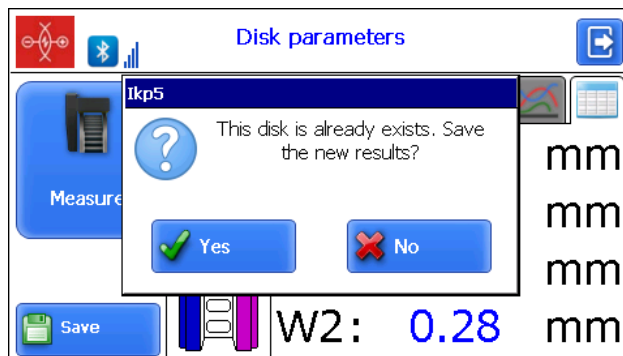

## 18. Browsing the database

Tap the **Profiles** button in the main window. View on the screen:

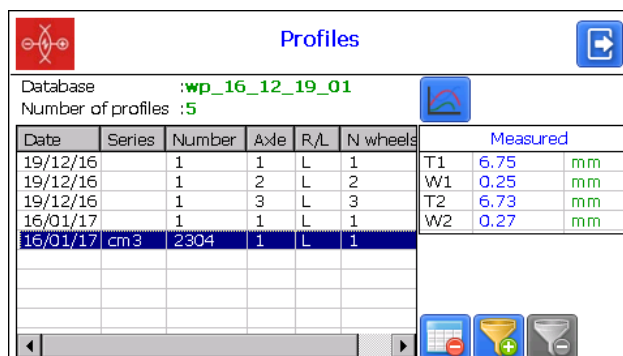

**Buttons:**

	Browse the profile of the selected disk
	Delete the selected disk
	Apply filtering
	Disable filtering
	Save the reference file

**18.1. Data filtering**

Tap the **Filter** button and select parameters.  
An example of filtering by the **Axle** parameter:

**Filter data**

Date: [dropdown]      Series: [dropdown]

Number: [dropdown]      Axle: [dropdown with value 1]

The filtered field will be highlighted in yellow:

**Profiles**

Database :wp\_16\_12\_19\_01

Number of profiles :3

Date	Series	Number	Axle	R/L	N wheels	Measured
19/12/16		1	1	L	1	T1 6.75 mm
16/01/17		1	1	L	1	W1 0.25 mm
16/01/17	cm3	2304	1	L	1	T2 6.73 mm
						W2 0.27 mm



To delete a current filter, tap .

**18.2. Visualization of the disk profile**

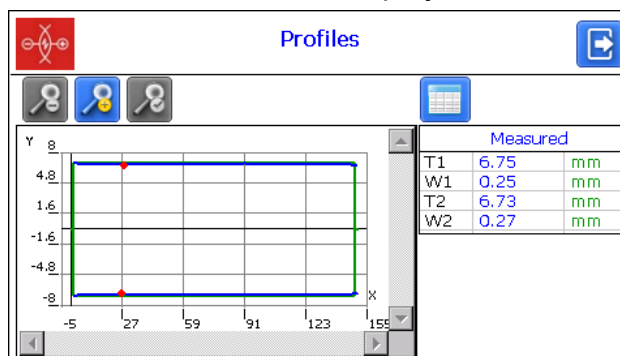
To browse the disk profile, you need to tap the **Profile** button - . The disk profile and the profile of the selected reference will be displayed on the PDA screen.



### Buttons:

	Zoom in
	Zoom out
	Standard image scale

## 19. Installation of software on PC and startup

### 19.1. Installation

The **ikd\_DB** software is intended for maintaining the database on a personal computer (the updated version of the program can be downloaded here [https://riftek.com/media/documents/ikd/Install\\_ikd.exe](https://riftek.com/media/documents/ikd/Install_ikd.exe)).

To install the software, insert a compact disk into the PC CD drive, select and start the **Install\_ikd.exe** file in the software folder. Follow instructions of the installation wizard. By default, the program will be installed in the following folder **C:\Program Files (x86)\Riftek, LLC\ikd\_db\**

### 19.2. Synchronization of PDA and PC

There are two ways of synchronization via USB cable to transfer data between PDA and PC:

- MS ActiveSync
- Mass Storage

When you select **MS ActiveSync**, synchronization with PC is performed via the **ActiveSync** software (Windows XP), or via **Windows Mobile Device Center** (Windows 7), which must be installed on PC. Installation files can be found on the supplied disk with the software.

In the PDA parameters, the **ActiveSync** must be selected as the synchronization type (see par. [12.6.](#)).

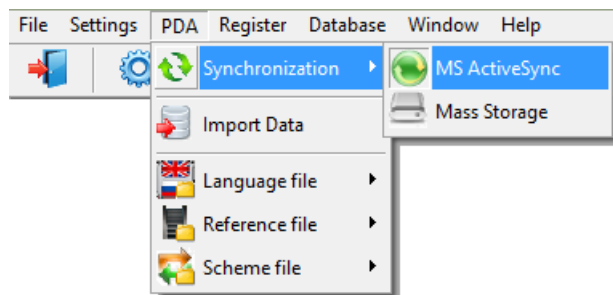

When you select **Mass Storage**, the device will be detected in Windows as an external storage device.

In the PDA parameters, the **Mass Storage** must be selected as the synchronization type (see par. [12.6.](#)).

To check the correctness of synchronization via **ActiveSync**, switch on the PDA and connect it to the UDP port of the PC by a supplied cable. If the connection is successful, the following message will appear on the screen:



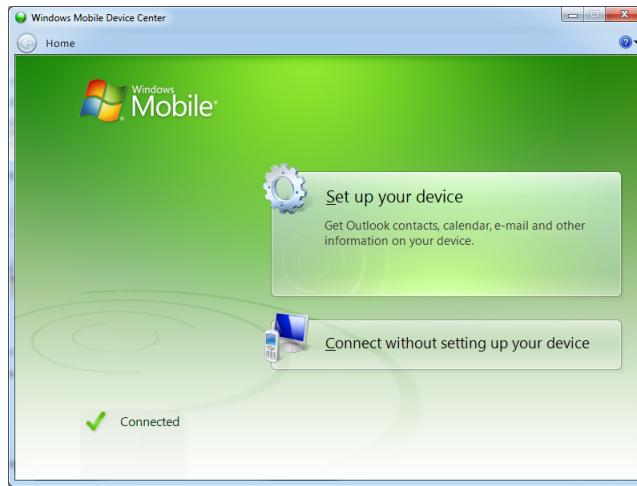

### 19.3. Program startup

To start the program, select **Start > All programs > Riftek, LLC > IKD\_DB > Ikd\_db.exe**. The main program window is shown below.

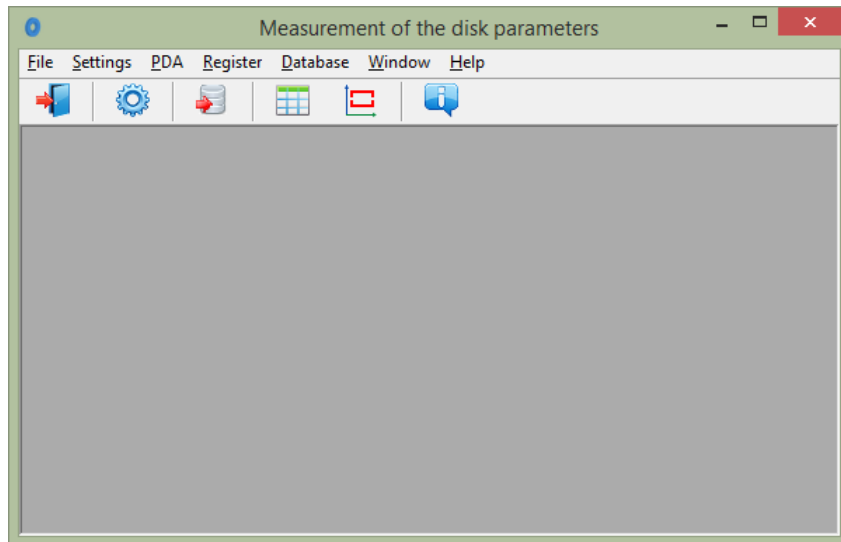

## 20. User settings of the program

### 20.1. Parameters setting

Select **Settings > Parameters** in the main window menu, or click .

Disk's parameters	
Measurement date	<input checked="" type="checkbox"/>
Measurement time	<input checked="" type="checkbox"/>
Wheelset	<input checked="" type="checkbox"/>
Number	<input checked="" type="checkbox"/>
Series	<input checked="" type="checkbox"/>
Axle	<input checked="" type="checkbox"/>
Operator	<input checked="" type="checkbox"/>
Mileage	<input checked="" type="checkbox"/>
Side	<input checked="" type="checkbox"/>

The **Parameters** window includes four tabs:

- Disk's parameters
- Calculated parameters
- L-parameters
- Measurement method

### 20.1.1. "Disk's parameters" tab

In this tab, you can select parameters, which will be displayed on the screen when browsing the database.

Disk's parameters   Calculated parameters   L-parameters   Measurement	
Name	Show/Hide
Measurement date	<input checked="" type="checkbox"/>
Measurement time	<input checked="" type="checkbox"/>
Wheelset	<input checked="" type="checkbox"/>
Number	<input checked="" type="checkbox"/>
Series	<input checked="" type="checkbox"/>
Axle	<input checked="" type="checkbox"/>
Operator	<input checked="" type="checkbox"/>
Mileage	<input checked="" type="checkbox"/>
Side	<input checked="" type="checkbox"/>

If the parameter is selected, its value will be shown in the table of results and in the table of profiles.

### 20.1.2. "Calculated parameters" tab

In this tab, the user can select geometrical parameters, which will be calculated and displayed on the screen when browsing the database.

Disk's parameters   Calculated parameters   L-parameters   Measurement	
Name	Show/Hide
Thickness (T1)	<input checked="" type="checkbox"/>
Wear (W1)	<input checked="" type="checkbox"/>
Wear (Dif1)	<input checked="" type="checkbox"/>
Full Thickness (D)	<input checked="" type="checkbox"/>

Descriptions and functions of parameters are the same as in the PDA software (see par. [10.](#)).

### 20.1.3. "L-parameters" tab

In this tab, the user can set values of L-parameters for calculated geometrical parameters of the disk.

Disk's parameters   Calculated parameters   L-parameters   Measurement		
Code	Value	
Parameter L1	100,00	mm

Descriptions and functions of L-parameters are the same as in the PDA software (see par. [10.](#)).

### 20.1.4. Selection of measurement units

All parameters and measurement results can be in the Metric system (millimeters), or in the English system (inches).

Select **mm** or **inch** in the **Measurement method** tab. After saving the changes, all information will be displayed in the selected units of measurement.

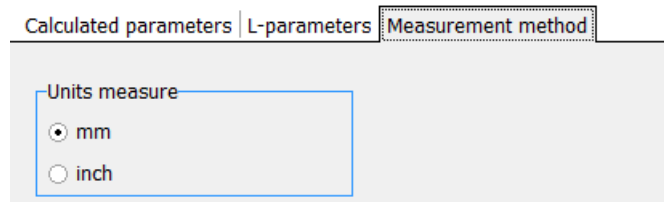

## 20.2. Database settings

### 20.2.1. Setting the path to database

The user can change the drive and the directory of the database storage. Select **File > Path to DB...** in the main menu.

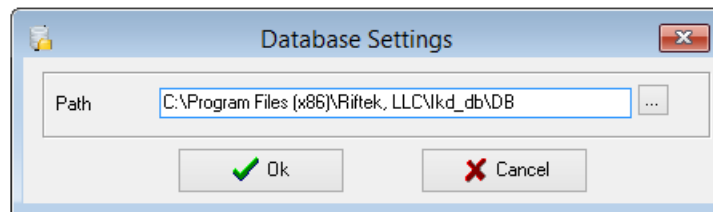

Next:

- click the select button
- specify a new path to the database
- confirm the creation of a new database

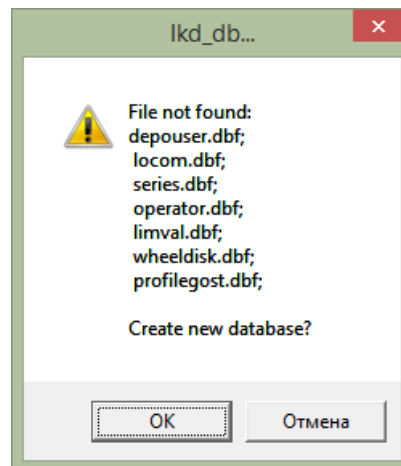

All database files will be copied to the specified path.

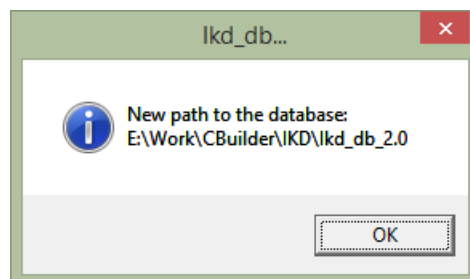

### 20.2.2. Creation of empty database

To create an empty database, select **File > New DB** in the main menu.

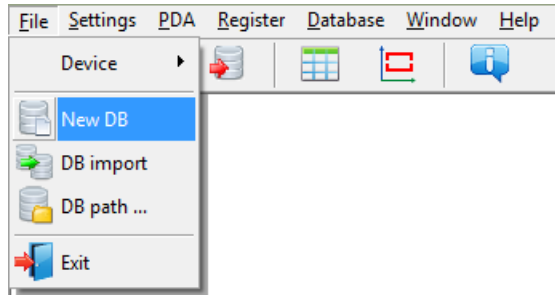

All data, excepting the reference files, will be deleted from the database. At the same time, catalog **DB(dd.mm.yy)** will be created in the installation directory whereto all deleted data (**dd.mm.yy** – current date) will be copied. Subsequently, these data can be restored (see par. [20.2.3](#)).

### 20.2.3. Import of database

To import data to the database from the other database (previously saved), you need to:

- Select **File > Import Data**.
- Select the folder with DB files in the left-hand window. All files will appear in the right-hand window:

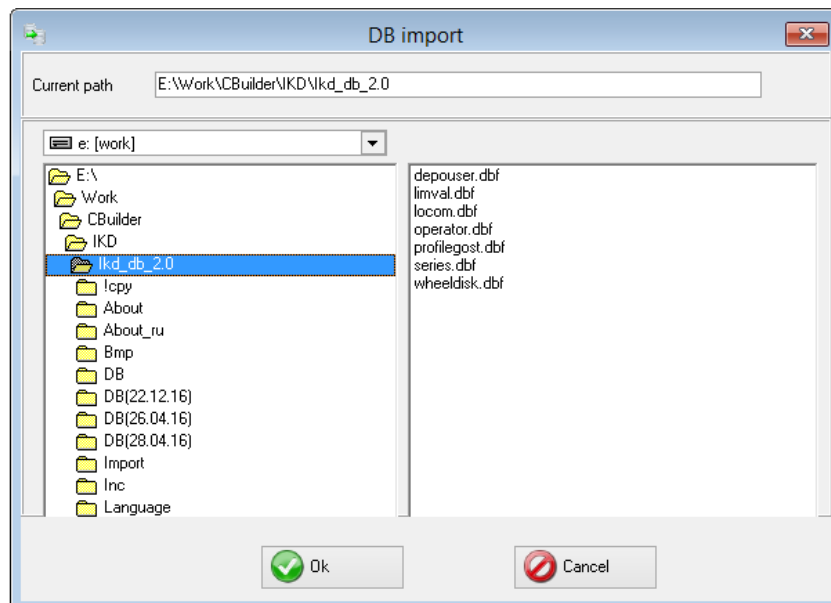

- Click **OK** to import data.

### 20.2.4. Language selection

In the main window, select **Settings > Language** and select the language support file.

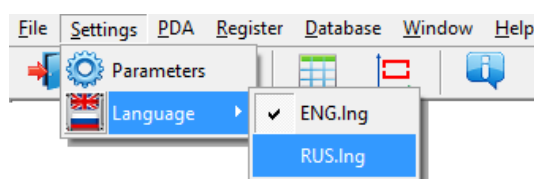

### 20.2.4.1. Preparation and installation of the language support file

The user can change the language, form his own language support files as well as change/edit the terminology used. Language support files are located in the directory used in the process of installation. By default, the following directory is used: **C:\Program Files (x86)\Riftek, LLC\ikd\_db\Language\**.

The directory contains two files, **RUS.Ing** and **ENG.Ing**, to support Russian and English languages respectively.

To create the support file for any other language, it is necessary to:

- copy one of the existing files. For example, **ENG.Ing** under the other name, for example, **DEU.Ing**;
- edit the renamed file by using any text processor, namely, change all terms and phrases to analogous ones from the required language;
- save the edited **\*.Ing** file in the **Language** folder.

To change and edit terminology, it is necessary to:

- edit the corresponding language file by using any text processor;
- save the edited **\*.Ing** file in the **Language** folder.



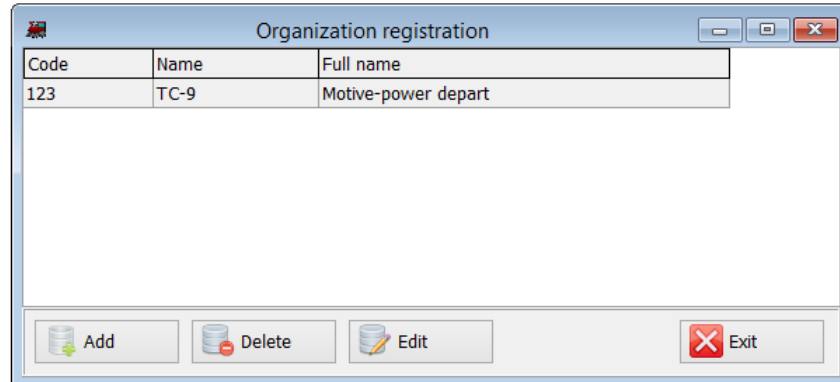

## 20.3. Registration data

### 20.3.1. Selection of the organization

To add/select the user organization, select **Registration > Organization** in the main window. Subsequently, this information will be used for obtaining data from the selected depot and for generating reports.



#### Buttons:

	Add a new organization
	Delete the selected organization
	Edit the selected organization
	Exit the organization registration mode

To select a current organization:

- Click **Edit**
- Tick the depot
- Click **Save**

Organization

Code

Name

Full name

### 20.3.2. Registration of operators

Steps to follow: menu **Registration** > **Operator**.

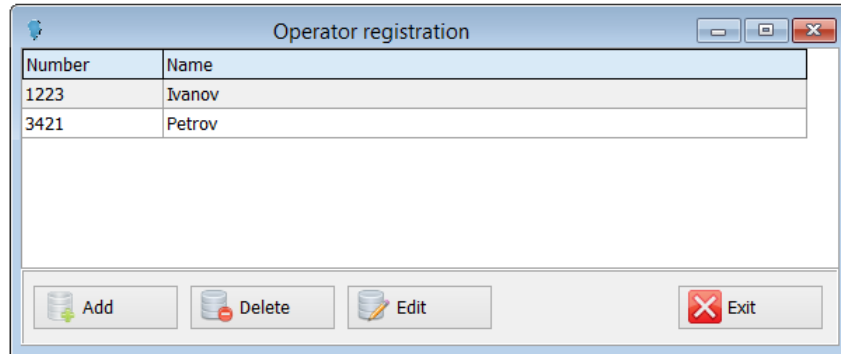

Functions of buttons are similar to those in par. [20.3.1](#).

### 20.3.3. Registration of series

Steps to follow: menu **Registration** > **Series**. Registered series of cars or locomotives are displayed in the emerged window.

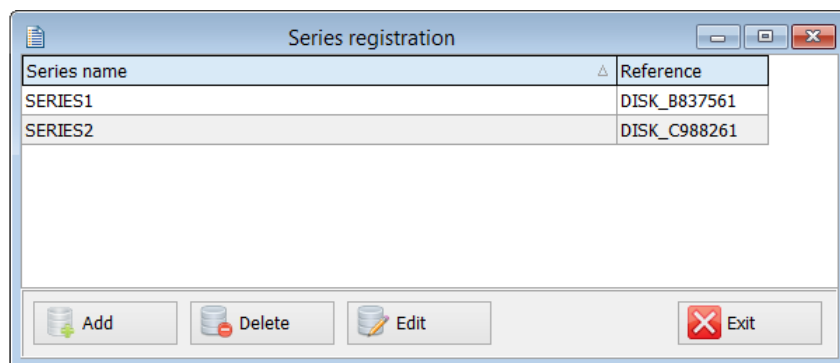

When registering a new series, a new entry for this series will be added to the table of tolerances automatically (see par. [20.3.5](#)).

Functions of buttons are similar to those in par. [20.3.1](#).

When adding a new series, it is necessary to enter the name of the series and select the reference profile for it. Flange parameters values of the selected profile will be calculated and added to the table of tolerances automatically after saving the series (see par. [20.3.6](#)).

### 20.3.4. Registration of car/locomotive numbers

Steps to follow: menu **Registration** > **Number**. Registered numbers of cars/locomotives are displayed in the emerged window.

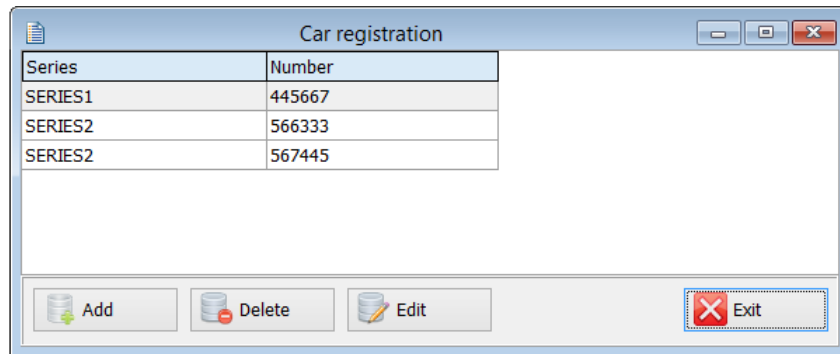

Functions of buttons are similar to those in par. [20.3.1](#).

### 20.3.5. Registration of tolerances

Steps to follow: menu **Registration** > **Tolerance**. Registered series of cars/locomotives with boundary values of calculated geometric parameters of the disk are displayed in the emerged window.

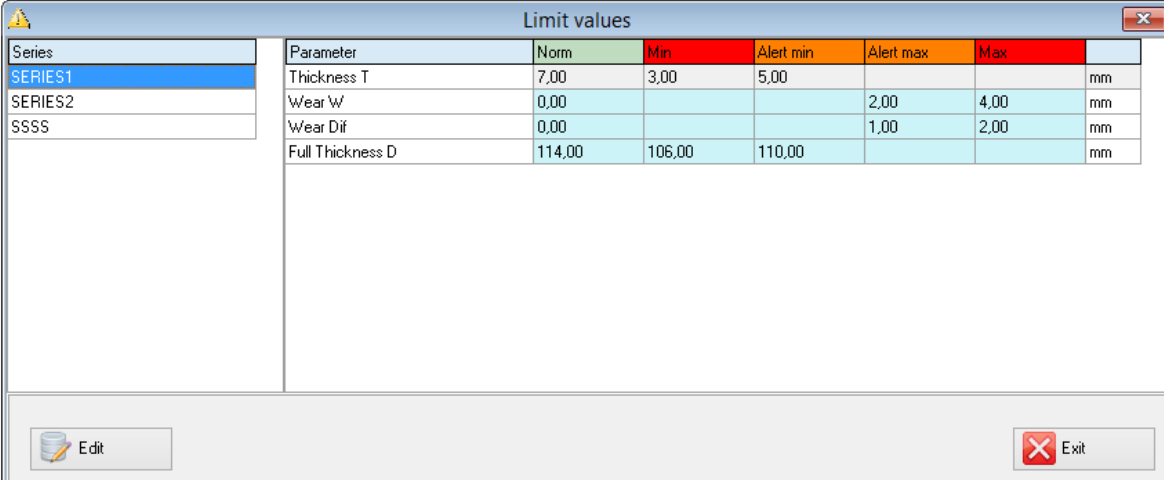

Series	Parameter	Norm	Min	Alert min	Alert max	Max	
SERIES1	Thickness T	7,00	3,00	5,00			mm
SERIES2	Wear W	0,00			2,00	4,00	mm
SSSS	Wear Dif	0,00			1,00	2,00	mm
	Full Thickness D	114,00	106,00	110,00			mm

Only parameters, which were selected in the list of parameters, are available for editing (see par. [20.1.2](#)).

Maximum/minimum critical values of parameters are indicated with a red color. An orange color indicates maximum/minimum values of parameters, which are close to critical.

The **Norm** value is calculated and added to the table automatically when adding/editing the series of the selected reference (see par. [20.3.3](#)).

### 20.3.6. Registration of reference profiles

The program comes with several preset profiles. In addition, the supplied disc with software contains the base of reference profiles. You can find profiles in the **Reference Profiles** directory in separate folders for each country.



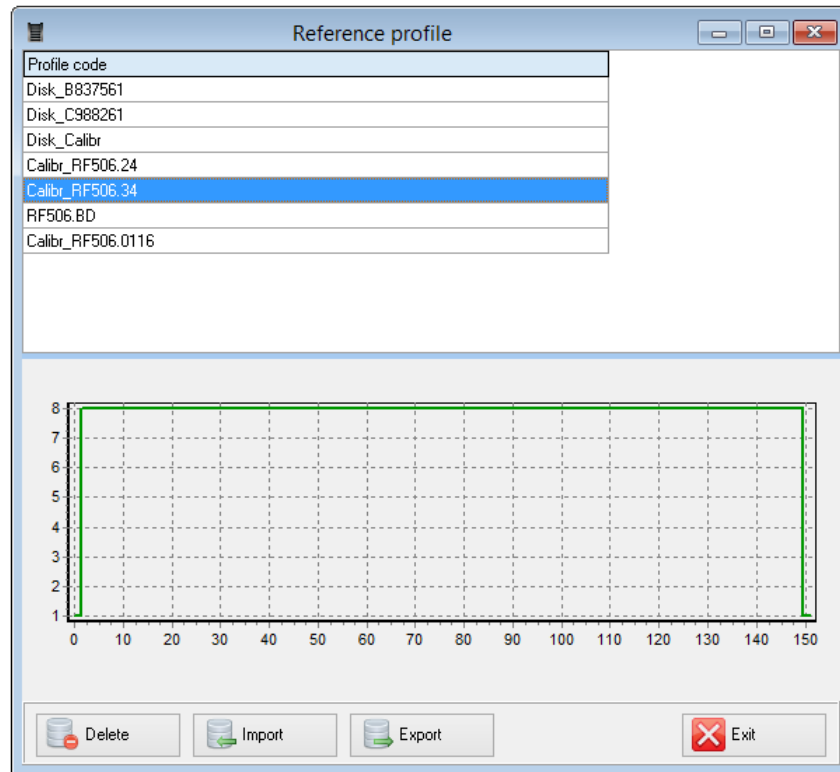

In addition, the user can form a description of the required profile himself or request it from RIFTEK (free service).

To browse available profiles, select **Registration** > **Reference**:



The **Reference profile** window displays the table with the list of reference profiles, saved to database, and a graphical view of the selected profile.

**Buttons:**

 Delete	Delete the reference profile
 Import	Import the reference profile from *.ref file
 Export	Export the reference profile to *.ref file
 Exit	Exit the organization registration mode

### 20.3.6.1. Request and registration of the profile file

To get .ref-file of reference profile, send the drawing of profile to RIFTEK ([info@riftek.com](mailto:info@riftek.com)). Register the received .ref-file as follows:

- click **Import**
- in the window appeared, indicate the path to the .ref-file
- click **Open**

The profile will be added to the base of reference profiles.



## 21. Data exchange between PDA and PC

To exchange data between PC and PDA, you need to select the device: **File > Device > RF303M-PDA.**

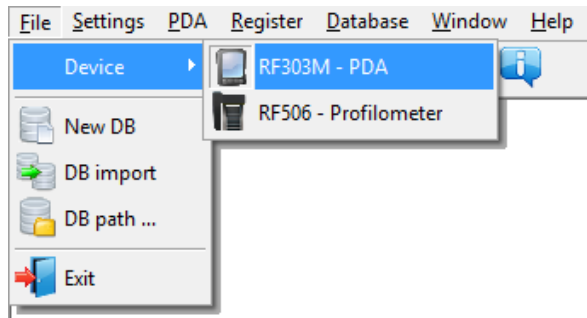

Data exchange between PC and PDA is performed by means of direct cable connection of PDA to PC USB-port (special **RF506.42** cable is supplied).

There are two ways of synchronization via USB cable:

- ActiveSync
- Mass Storage

For more details, see par. [19.2.](#)

### 21.1. ActiveSync synchronization

When you select this type of synchronization, additional features of data exchange with PDA will be available:

- Transfer of database files to PC
- Transfer of language files
- Transfer of reference profile files
- Transfer of processing scheme files

#### 21.1.1. Transfer of database file to PC

To transfer the database file from PDA to PC, it is necessary to:

- select **PDA > Import Data**

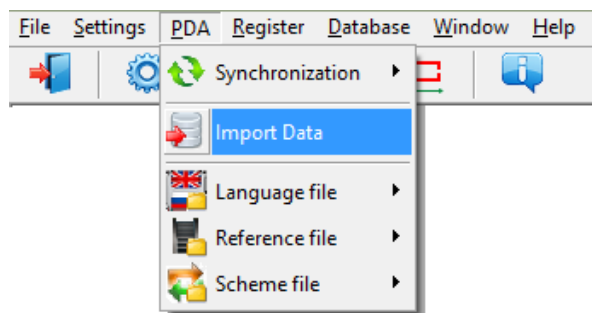

- mark the required files in the emerged window and click **Ok**

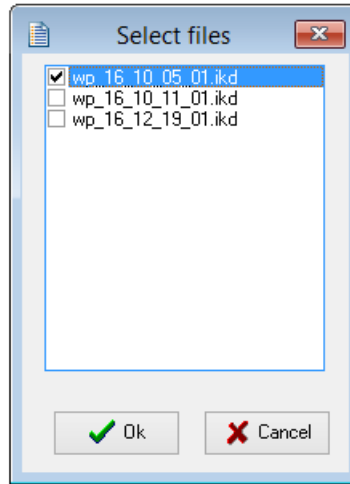

### 21.1.2. Transfer of language file from PC to PDA

To transfer the language file from PC to PDA, it is necessary to:

- select **PDA > Language file > Export**

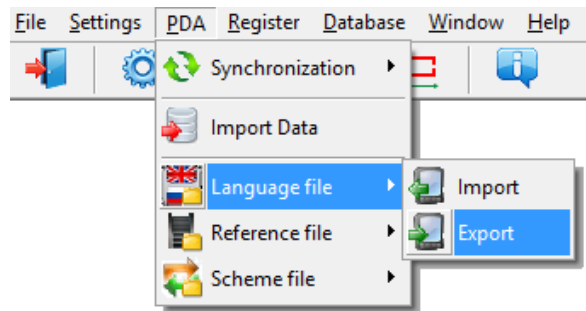

- select the required file

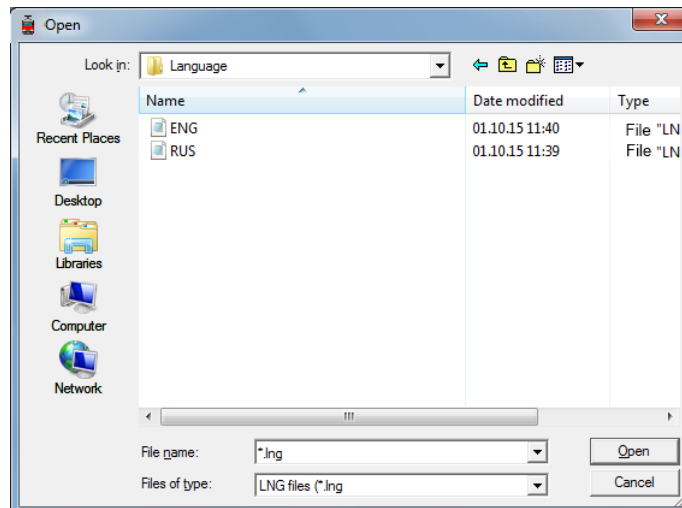

If transfer is successful, the screen will show:

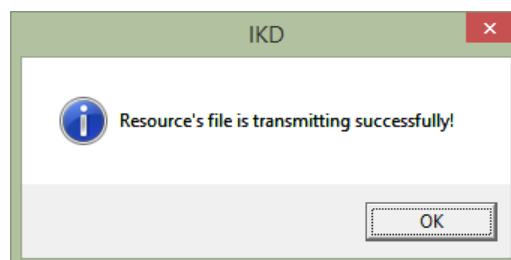

### 21.1.3. Transfer of language file from PDA to PC

To transfer the language file from PDA to PC, it is necessary to:

- select **PDA > Language file > Import**

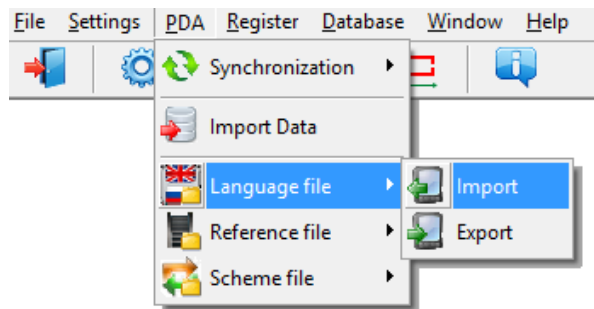

- select the required file

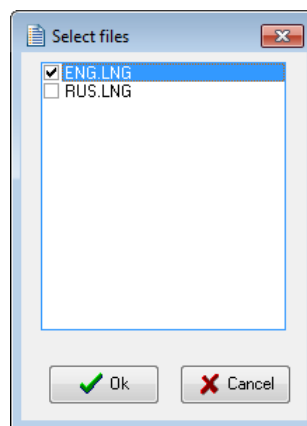

If transfer is successful, the selected files will be saved to the specified path.

### 21.1.4. Transfer of reference profile files from PC to PDA

To transfer the reference profile file from PC to PDA, it is necessary to:

- select **PDA > Reference file > Export**

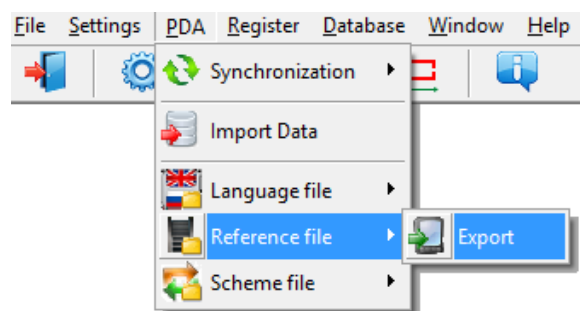

- select the required **.ref** file

If transfer is successful, the screen will show:

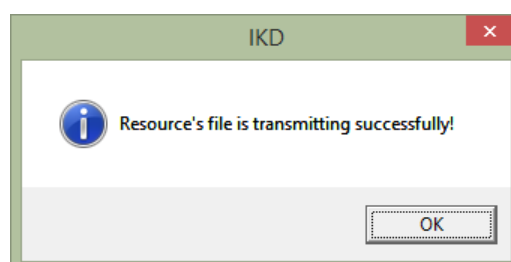

### 21.1.5. Transfer of processing scheme file from PC to PDA

To transfer the processing scheme file from PC to PDA, it is necessary to:

- select **PDA > Scheme file > Export**

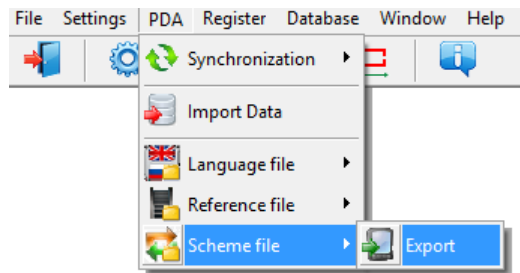

- select the required **.sch** file  
If transfer is successful, the screen will show:

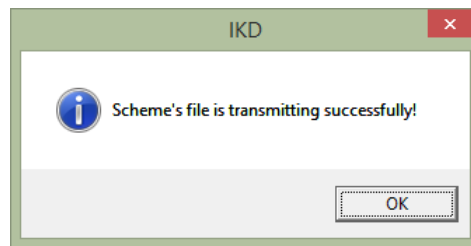

### 21.2. Mass Storage synchronization

When you select this type of synchronization, PDA is detected as an external storage device. Therefore, the only **Import Data** item is active. Transfer of language/scheme/reference files from PDA to PC and back can be performed by simple copying.

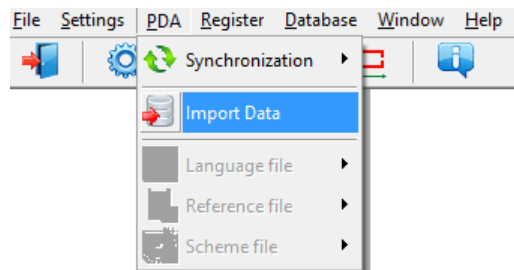

To transfer database files from PDA to PC, it is necessary to:

- select **PDA > Import Data**
- specify the path to the database on PDA (by default, **SDMMC\Autorun\DB**)

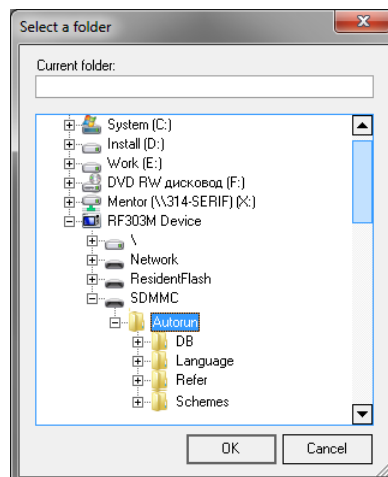

- mark the required files in the emerged window and click **Ok**

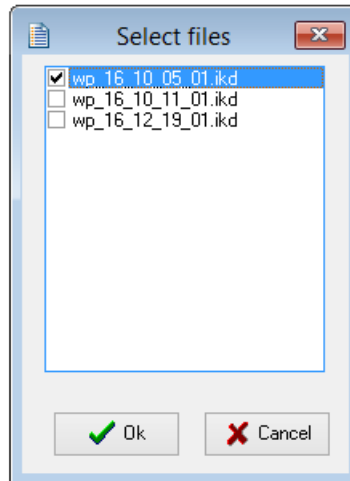

## 22. Working with profilograms

### 22.1. Browsing the graph and the profile coordinates



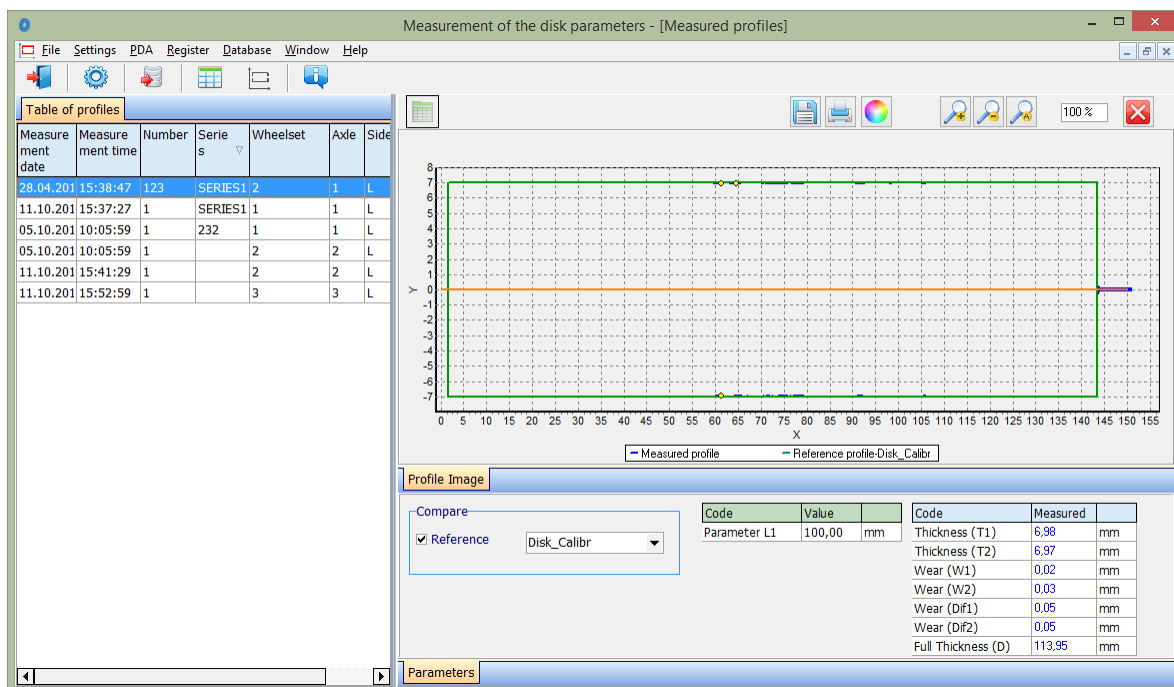

To browse the saved profiles of the rolling surface, select **Database > Profiles**, or click the **Profiles** button - .



At the left side of the window you can see the **Table of profiles** tab, which contains a list of saved profiles. The table displays only the identification parameters of the disk, which were selected in the parameters window (see par. [20.1.](#)).

When selecting a profile, it is possible to browse a graphical image and geometric parameters of the measured disk. To browse the coordinates of the selected profile you need to click the **Profile Values** button. After that an additional tab with the measured coordinates will appear.

## Buttons:

	Show/hide the Profile Values tab
	Save the profile image to file (.bmp file)
	Print the profile image
	Change the background color of the graph
	Zoom in/out the profile graph

## 22.2. Parameters tab

Calculated geometric parameters of the profile as well as L-parameters values are displayed on the **Parameters** tab, which is at the bottom of the window.

Compare <input checked="" type="checkbox"/> Reference    Disk_Calibr		<table border="1"> <thead> <tr> <th>Code</th> <th>Value</th> <th></th> </tr> </thead> <tbody> <tr> <td>Parameter L1</td> <td>100,00</td> <td>mm</td> </tr> </tbody> </table>	Code	Value		Parameter L1	100,00	mm	<table border="1"> <thead> <tr> <th>Code</th> <th>Measured</th> <th></th> </tr> </thead> <tbody> <tr> <td>Thickness (T1)</td> <td>6,98</td> <td>mm</td> </tr> <tr> <td>Thickness (T2)</td> <td>6,97</td> <td>mm</td> </tr> <tr> <td>Wear (W1)</td> <td>0,02</td> <td>mm</td> </tr> <tr> <td>Wear (W2)</td> <td>0,03</td> <td>mm</td> </tr> <tr> <td>Wear (Dif1)</td> <td>0,05</td> <td>mm</td> </tr> <tr> <td>Wear (Dif2)</td> <td>0,05</td> <td>mm</td> </tr> <tr> <td>Full Thickness (D)</td> <td>113,95</td> <td>mm</td> </tr> </tbody> </table>	Code	Measured		Thickness (T1)	6,98	mm	Thickness (T2)	6,97	mm	Wear (W1)	0,02	mm	Wear (W2)	0,03	mm	Wear (Dif1)	0,05	mm	Wear (Dif2)	0,05	mm	Full Thickness (D)	113,95	mm
Code	Value																																
Parameter L1	100,00	mm																															
Code	Measured																																
Thickness (T1)	6,98	mm																															
Thickness (T2)	6,97	mm																															
Wear (W1)	0,02	mm																															
Wear (W2)	0,03	mm																															
Wear (Dif1)	0,05	mm																															
Wear (Dif2)	0,05	mm																															
Full Thickness (D)	113,95	mm																															

### 22.2.1. Selection of comparison profile

To compare a profile with a reference, it is necessary to tick the **Compare** field and select the required reference profile in the drop-down list.

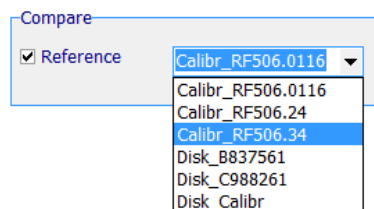

### 22.2.2. Geometric parameters of the profile

The table of measured geometric parameters displays only parameters, which were selected in the parameters window (see par. [20.1.2](#)).

Code	Measured	
Thickness (T1)	3,92	mm
Thickness (T2)	5,69	mm
Wear (W1)	1,78	mm
Wear (W2)	0,01	mm
Wear (Dif1)	0,52	mm
Wear (Dif2)	2,08	mm
Full Thickness (D)	109,97	mm

Parameters, which are beyond the set tolerances, are highlighted in red/orange (see par. [20.3.5](#)).

## 22.3. Wear calculation

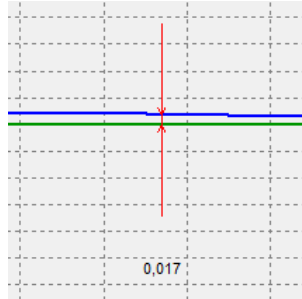

### 22.3.1. Fast wear calculation

To obtain fast calculation of the profile wear at a certain point relative to the reference, put cursor bar to any of the profiles, and when a cross-like (+) mouse cursor appears press the left mouse key. The resulting screen will show the value of the coordinate difference between profiles taken along X- and Y-axes, as shown by arrows:



To remove size indication from the screen, it is necessary to put cursor to any of the profiles and press the right mouse key.

## 22.4. Rescaling

To change the image scale, mark a part of the image with the left mouse key, move the image by holding it with the right mouse key pressed, or use the buttons **Increase** - , **Decrease** -  and **Show all** - .

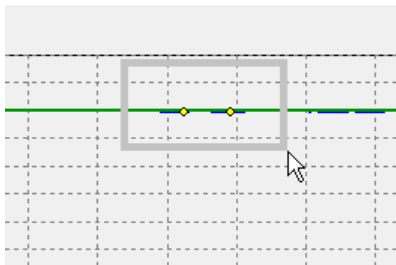

## 23. Scanning and editing of data

### 23.1. Scanning and filtering of data

To scan data, select **Database > Table** in the menu or click the **Table** button - . The form with results will be as follows:

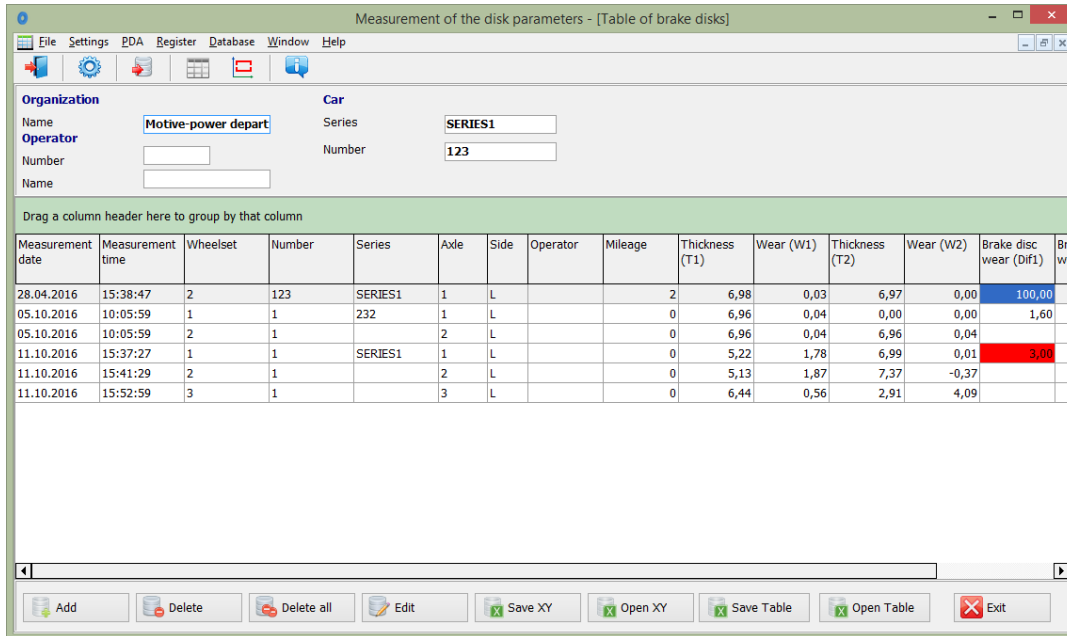

- **Hide/show the field**

The table displays the identification and geometric parameters of the wheelset, which are marked for displaying in the parameters settings (see par. [20.1.1](#) and [20.1.2](#)).

- **Sorting of data**

To sort data for any of the fields, click the left mouse key on the header of the field column:

Measurement date	Measurement time	Wheelset
03.12.2015	13:56:49	1
03.12.2015	13:57:33	2
03.12.2015	16:19:34	1
03.12.2015	17:05:10	1

➔

Measurement date	Measurement time	Wheelset <span style="font-size: 0.8em;">▼</span>
03.12.2015	13:56:49	1
03.12.2015	16:19:34	1
03.12.2015	17:05:10	1
03.12.2015	13:57:33	2

To cancel data sorting, press the **Ctrl** key and click the left mouse key on the header of the field column.

- **Filtering of data**

In order to filter data in any of the fields, click the left mouse key on the header of the field grouping, and select a required value in the emerged drop-down list:

Measurement	Measurement time	Wheelset
(All)	13:56:49	1
(Custom...)	13:57:33	2
<input type="checkbox"/> 03.12.2015	16:19:34	1
<input type="checkbox"/> 06.01.2016	17:05:10	1
06.01.2016	11:00:03	SU000111
06.01.2016	11:00:03	SU000112
06.01.2016	11:00:03	SU000113
06.01.2016	11:00:03	SU000114

➔

Measurement date	Measurement time	Wheelset
06.01.2016	11:00:03	SU000111
06.01.2016	11:00:03	SU000112
06.01.2016	11:00:03	SU000113
06.01.2016	11:00:03	SU000114

To cancel filtering, all steps should be taken in the reverse order.



**• Data grouping**

To group data for any of the fields, click the left mouse key on the header of the field column, and, with the mouse key pressed, drag it onto the table header:

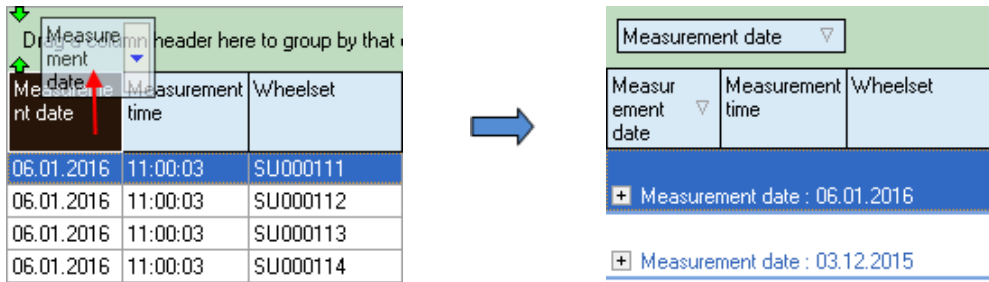

**• Changing the field position order**

To change the field position, click the left mouse key on the header of the field column and, with the mouse key pressed, drag it to the required position:

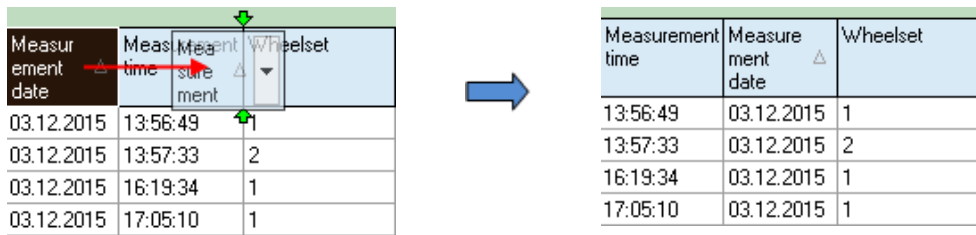

**Buttons:**

	Add the disk
	Delete the selected brake disk
	Delete all brake disks
	Edit the selected brake disk
	Export the coordinates of brake disks to the Excel format

**23.2. Editing data**

You can edit, add and remove data in/from the database.

**• Editing data**

To edit the current entry, click the button and input/change the values of parameters. To save changes, click the **Save** button.

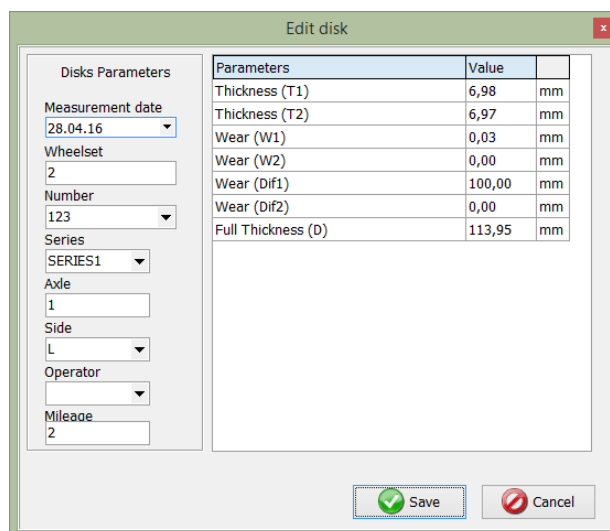

### • Adding data

To add a new entry, click the  button and enter the values of parameters. Click the **Save** button to save a new entry.

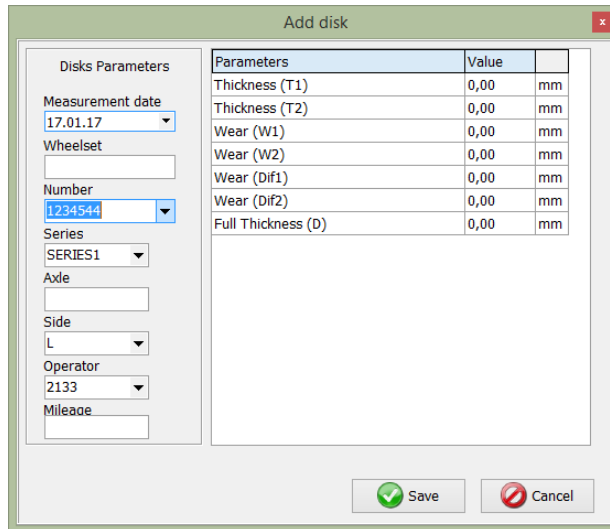

### • Deleting data

To delete the current entry, click the  button and then click **OK** to confirm.

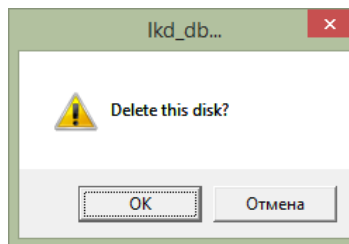

### • Deleting all selected data

If you need to delete several entries combined by some condition, apply filtering as shown in par. [23.1.](#), click the  button and confirm the action.

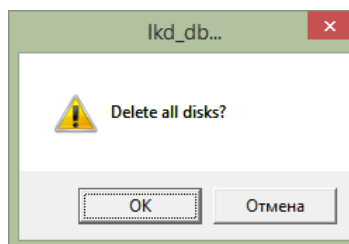

## 23.3. Excel-format report

You can save data in the Excel format.

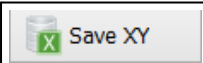
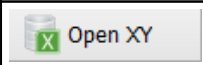
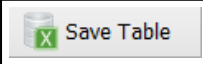
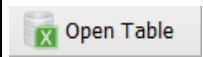
	Save coordinates X, Y to a file (Excel)
	Open a file with coordinates of profiles
	Save a table with parameters of profiles to a file (Excel)
	Open a table with parameters of profiles

## 24. Taking measurements under PC control (without PDA)

The laser scanning module (RF506) can work under direct control of PC without PDA. To work under direct control of PC, it is necessary to select **File > Device > RF506-Profilometer** in the main menu.

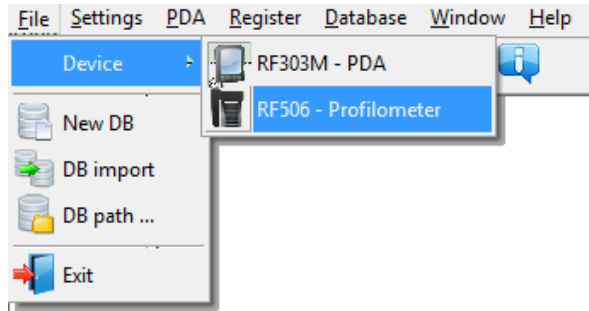

The **PDA** item will be replaced with the **Profilometer** item in the main menu of the program.

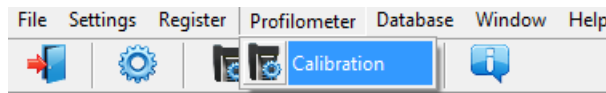

The menu contains one item:

- Calibration

Before starting to work with the profilometer, it is necessary to set the COM-port for Bluetooth-connection between the laser scanning module and PDA. The procedure is described in the User's Manual that comes with the Bluetooth-adapter.

### 24.1. Calibration

Select **Profilometer > Calibration**, or click the button .

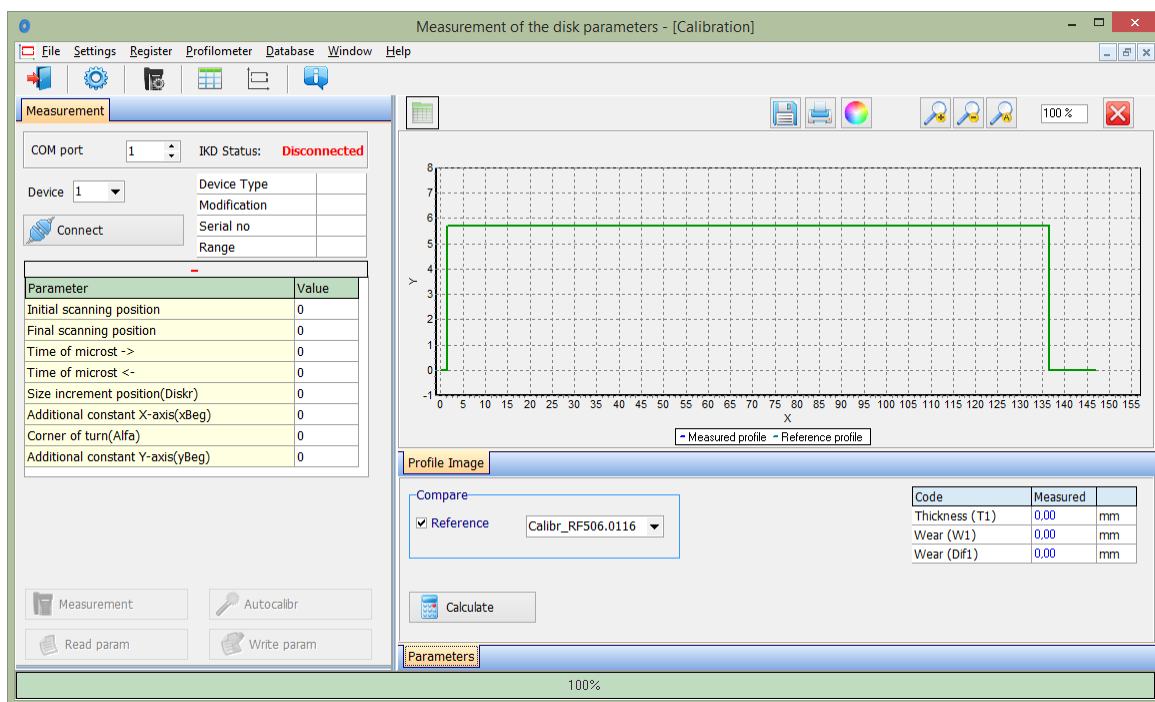

### 24.1.1. Installation of Bluetooth-connection

Select the COM-port and click the **Connect** button.

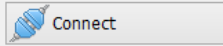
COM port	19	IKD Status:	Disconnected
Device	1	Device Type	
		Modification	
		Serial no	
		Range	





If the connection is established, the device will be identified, and calibration parameters will be obtained. The status will be changed to **Connected**.

COM port	19	IKD Status:	Connected
Device	1	Device Type	56
		Modification	53
		Serial no	112
		Range	8

The table of calibration parameters:

Parameter	Value
Initial scanning position	12
Final scanning position	3060
Time of microst ->	10
Time of microst <-	5
Size increment position(Diskr)	495
Additional constant X-axis(xBeg)	6000
Corner of turn(Alfa)	341
Additional constant Y-axis(yBeg)	4338

**Buttons:**

 Measurement	Measurement
 Read param	Read calibration parameters
 Write param	Write calibration parameters
 Autocalibr	Set calibration parameters automatically



The **Auto calibration** button will be active, if at least one measurement of the profile is performed as well as the reference profile is selected.

### 24.1.2. Calibration of the profilometer

- Place the profilometer on the calibration block.
- Select the reference profile from the list (**Compare > Reference**).
- Perform the measurement (the **Measurement** button)
- Perform the calibration (the **Autocalibr** button)
- Save calibration parameters (the **Write param** button).

Calibration parameters can be set manually. Click the left mouse key in the field of the parameter value, and enter the new value.



**Attention!** Writing incorrect values of some parameters can lead to the incorrect work of the device.

Buttons functions are described in par. [20](#).

## 25. Annex 1. Charging procedure

- Switch off the PDA (laser module).
- Connect the charging device to PDA (laser module).
- Connect the charging device to 220V.
- Time of charging – 4 hours, until the blue LED is lit.
- Disconnect the charging device from 220V.
- Disconnect the charging device from PDA (laser module).

## 26. Annex 2. Program for making measurement schemes

To create the measurement schemes, the user can use the special program **SchemeBuilder.exe**. When the program is started, the main window appears on the screen:

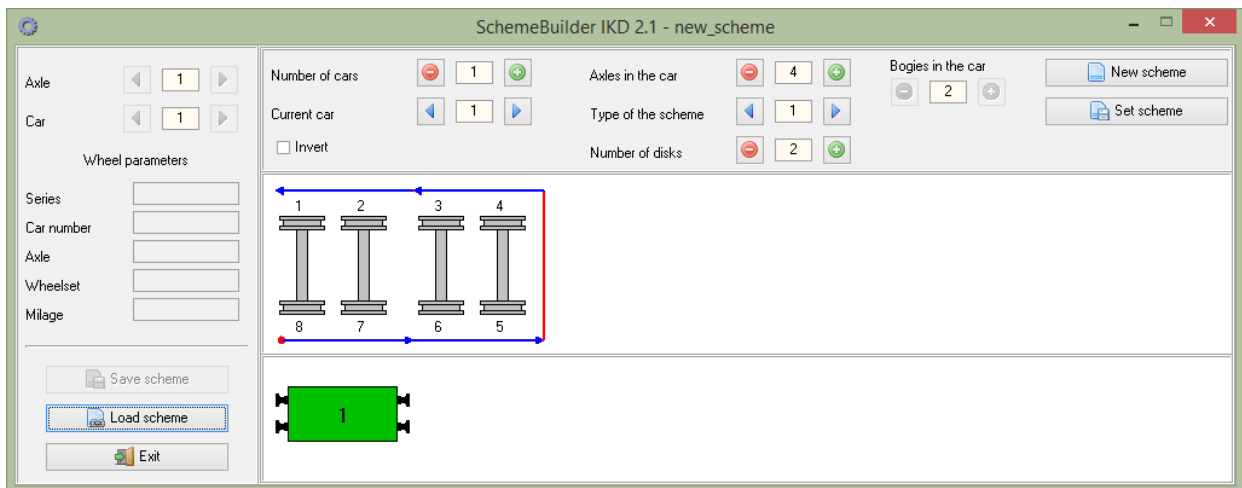

To form the scheme:

- Enter the number of cars
- Enter the number of axles in every car
- If the measurement of the car is performed in the reverse order, tick the **Invert** box
- Select the type of the scheme
- Click the button to accept
- Next, enter parameters of all wheelsets sequentially for each car

Wheel parameters	
Series	Series
Car number	1234
Axle	1
Wheelset	11
Run	

- The fields **Axle** and **Car** are used to navigate through the scheme

Axle	1
Car	1

- Click the **Save scheme** button
- Enter the name of the scheme

Save scheme
-------------

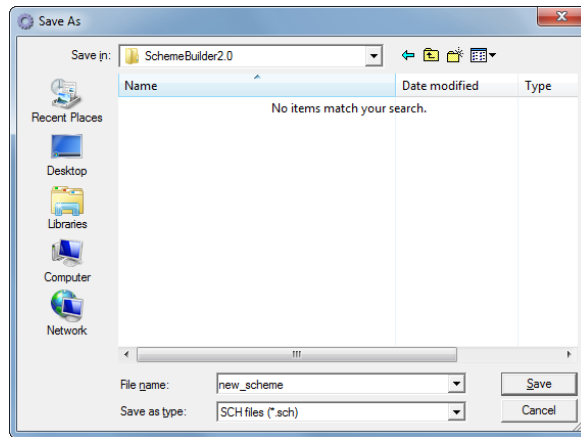

The user can edit the existing scheme. To edit the scheme, click the **Load scheme** button and select the **.sch** file. After loading, you can edit and save the wheelset parameters.

To transfer the scheme file to PDA, use the procedure described in par. [21.1.5](#).

**Clarification.** The measurement scheme is a text file with extension **.sch**. User can create and edit such file by using any text processor.

**Example:**

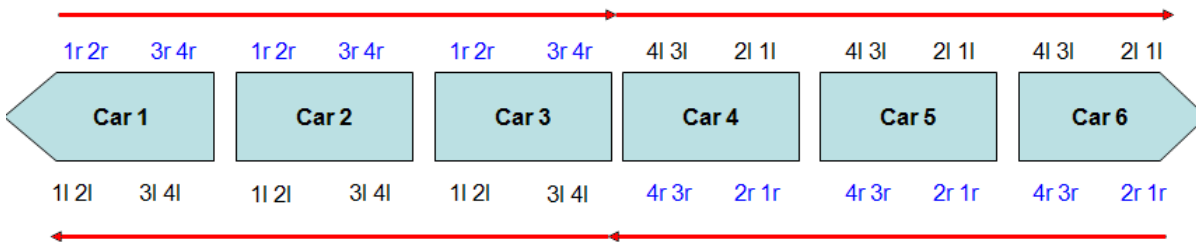

Scheme\_EXAMPLE

```
{
1d-|SM 3|7102|1|11|SU11|111|1r|11|SU11|111|2|12|SU12|112|2r|12|SU12|112|3|13|SU13|113|3r|13|SU13|113|4|14|SU14|114|4r|14|SU14|114|;
2d-|SM 3|7202|1|12|SU21|211|1r|21|SU21|211|2|22|SU22|212|2r|22|SU22|212|3|23|SU23|213|3r|23|SU23|213|4|24|SU24|214|4r|24|SU24|214|;
3d-|SM 3|7302|1|13|SU31|311|1r|31|SU31|311|2|32|SU32|312|2r|32|SU32|312|3|33|SU33|313|3r|33|SU33|313|4|34|SU34|314|4r|34|SU34|314|;
4i-|SM 3|7402|4r|44|SU044|414|4|44|SU44|414|3r|43|SU43|413|3|43|SU43|413|2r|42|SU42|412|2|42|SU42|412|1r|41|SU41|411|1|41|SU41|411|;
5i-|SM 3|7502|4r|54|SU54|514|4|54|SU54|514|3r|53|SU53|513|3|53|SU53|513|2r|52|SU52|512|2|52|SU52|512|1r|51|SU51|511|1|51|SU51|511|;
6i-|SM 3|7602|4r|64|SU064|614|4|64|SU64|614|3r|63|SU63|613|3|63|SU63|613|2r|62|SU62|612|2|62|SU62|612|1r|61|SU61|611|1|61|SU61|611|;
}
```

Where:

- 1d – cars arranged in direct order (1 – sequence number)
- 1i – cars arranged in the reverse order (1 – sequence order)
- SM3 – car series
- 7102 – number
- 1l – sequence number of wheelset and the side (l- left/r-right)
- 11 – axle number
- SU11 – name of wheelset
- 111 – running distance of wheelset

## 27. Annex 3. Testing and calibration

We can supply the IKD complete with a calibration-disk simulation unit (see p. [27.2.](#)) and **RF506Calibr** calibration program that are designed for periodic testing and self-calibration of the IKD.

Instead of the calibration unit use can be made of the disk with known profile entered to the database (see par. [20.3.6](#)).

Before start the testing and calibration process, it is necessary to set the COM-port for Bluetooth-connection between the laser scanning module and PC. The procedure is described in the User's Manual that comes with the Bluetooth-adapter.

## 27.1. Preparation for testing/calibration

- Install the **RF506Calibr** program on the PC.
- Install Bluetooth-connection between the scanning module and PC.
- Place the profilometer on the calibration unit.
- Run **RF506Calibr** program.

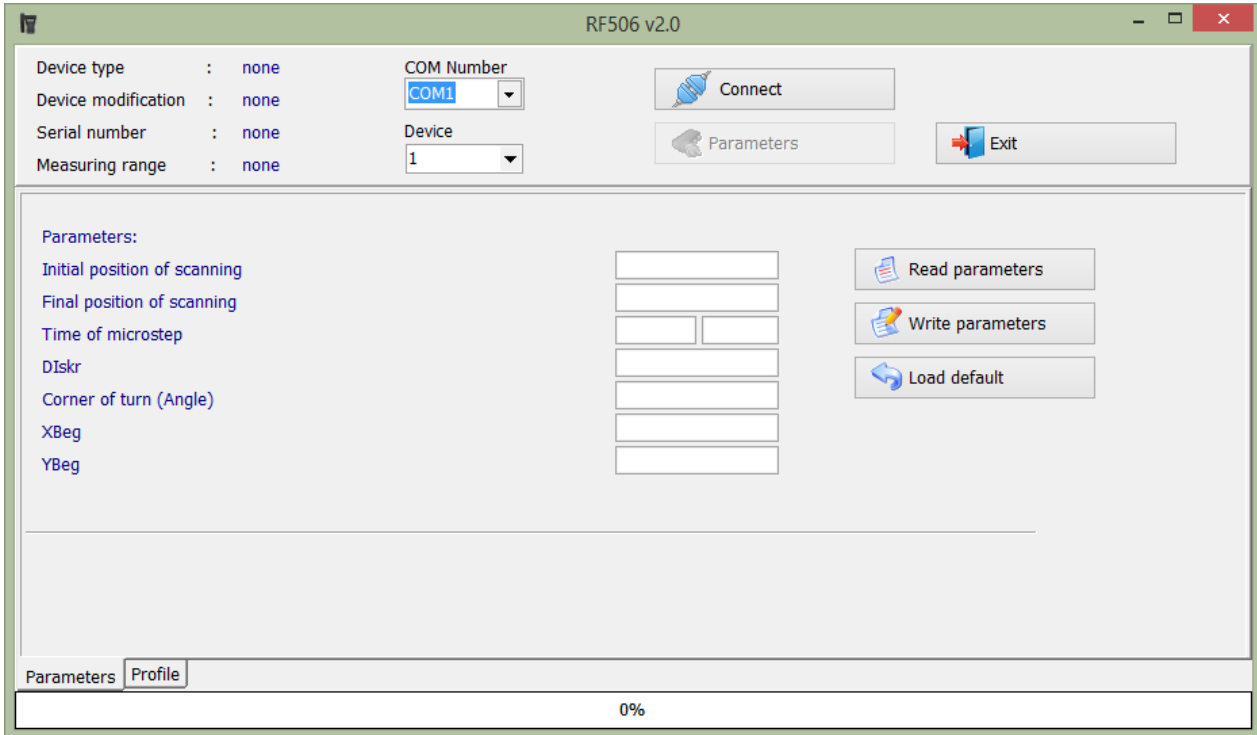

- To install Bluetooth-connection, select the required port.

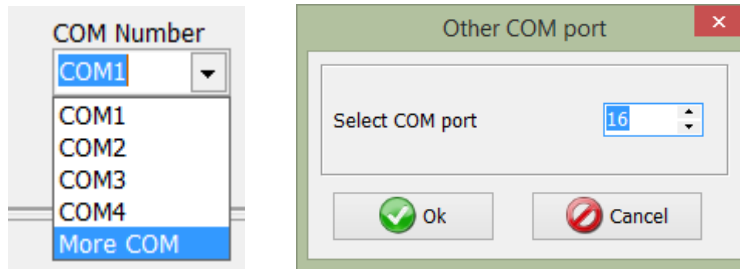

The device will be identified, and calibration parameters will be read.

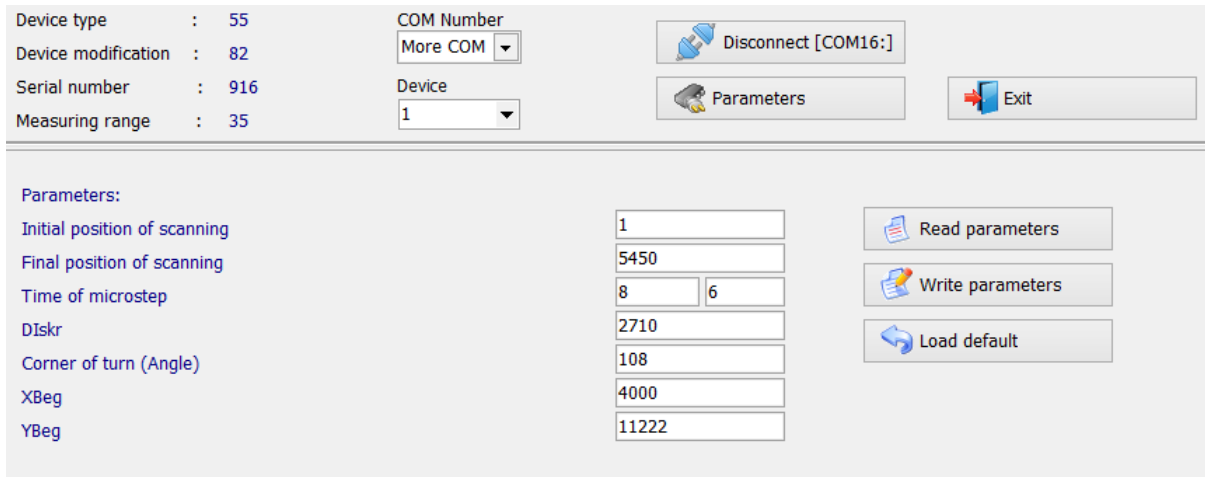

- To measure the profile, press the **Measure** button. The display will show measured profiles after measurement has been taken.

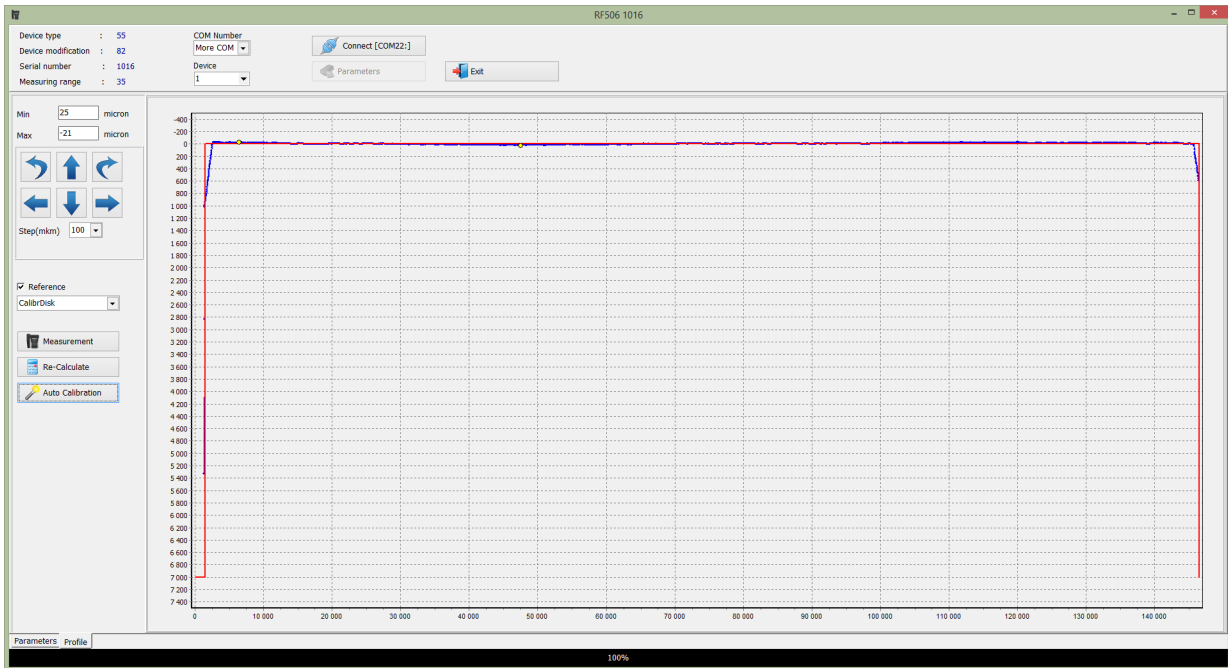

- To compare with the reference, tick the **Compare** box and select the required reference profile in the **Reference** drop-down list.

## 27.2. Calibration

To carry out an automatic calibration, do the following steps:

- Select the reference profile from the list.
- Perform the measurement (the **Measuring** button).
- Perform the calibration (the **Auto calibration** button).
- Perform the testing measurement. If successful, go to the **Parameters** tab and save parameters (the **Write parameters** button).

Parameters:

Initial position of scanning	<input type="text" value="1"/>	<input type="button" value="Read parameters"/> <input style="border: 2px solid red;" type="button" value="Write parameters"/> <input type="button" value="Load default"/>
Final position of scanning	<input type="text" value="5450"/>	
Time of microstep	<input type="text" value="8"/> <input type="text" value="6"/>	
DIskr	<input type="text" value="2710"/>	
Corner of turn (Angle)	<input type="text" value="108"/>	
XBeg	<input type="text" value="4000"/>	
YBeg	<input type="text" value="11222"/>	

- If parameters have incorrect values (negative or zero) for any reason, it is necessary to restore factory settings by pressing the **Load Default** button. After that, recalibrate the profilometer.



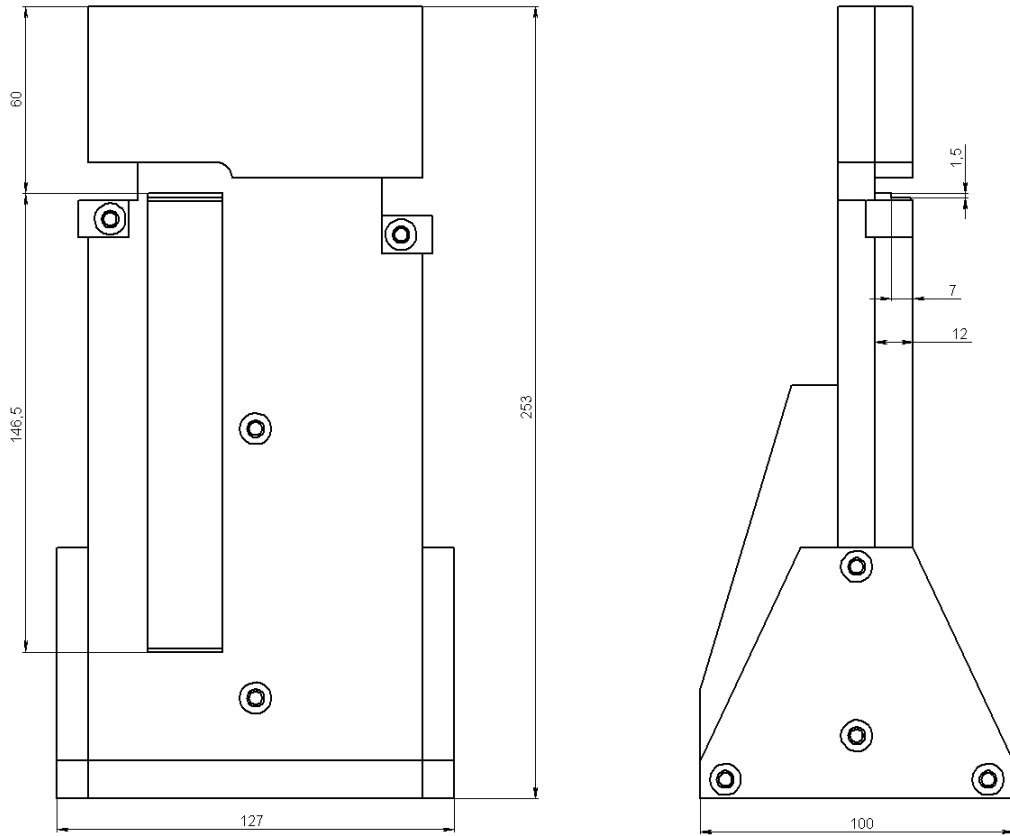

Figure 1A(RF506.51.002)

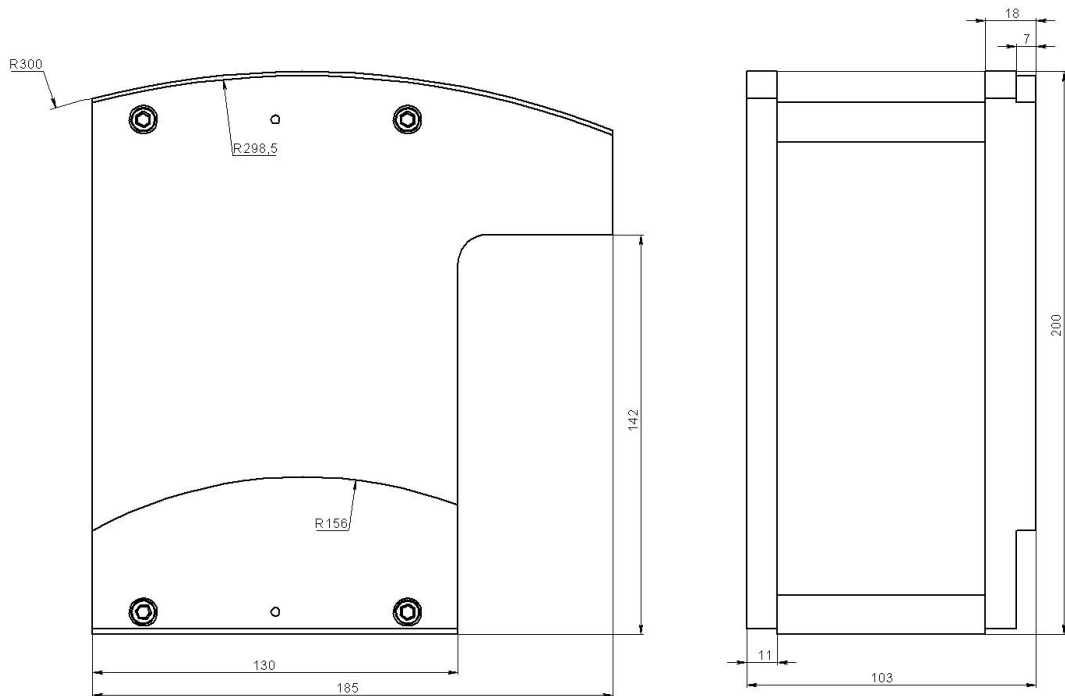

Figure 1B(RF506.41.000-01)

## 28. Warranty policy

Warranty assurance for the Disc Brakes Profile Gauge IKD Series - 24 months from the date of putting in operation; warranty shelf-life - 12 months.

## 29. List of changes

Date	Revision	Description
06.02.2017	1.0.0	Starting document.
28.09.2018	2.0.0	<b>IKD-universal</b> – Profilometer designed to measure parameters of the disc brakes installed on the wheel and on the wheelset axle.

## 30. Distributors

### AUSTRIA

**MBM Industry & Rail Tech GmbH**

**RAILWAY INSTRUMENTS ONLY**

Tullnerbachstraße 36,  
A-3002 Purkersdorf, Austria  
Tel: +43 2231 66000  
Fax: +43 2231 66000 12  
[office@mbm-industrietechnik.at](mailto:office@mbm-industrietechnik.at)  
[www.mbm-tech.at](http://www.mbm-tech.at)

### AUSTRALIA

**Applied Measurement Australia Pty Ltd**

**RAILWAY INSTRUMENTS ONLY**

Thornton Plaza, Unit 5,  
27 Thornton Crescent, Mitcham  
VIC 3132, Australia  
Tel: +61 39874 5777  
Fax: +61 39874 5888  
[sales@appliedmeasurement.com.au](mailto:sales@appliedmeasurement.com.au)  
[www.appliedmeasurement.com.au](http://www.appliedmeasurement.com.au)

### BENELUX

**Althen Sensors & Controls BV**

Vlietweg 17a  
2266KA Leidschendam  
The Netherlands  
Tel: +31 70 3924421  
Fax: +31 70 3644249  
[sales@althen.nl](mailto:sales@althen.nl)  
[www.althensensors.com](http://www.althensensors.com)  
[www.althencontrols.com](http://www.althencontrols.com)

### BULGARIA, HUNGARY

**RMT Ltd.**

R Zahradni 224  
739 21 Paskov, Czech Republic  
Tel: +420 558640211  
Fax: +420 558640218  
[rmt@rmt.cz](mailto:rmt@rmt.cz)  
[www.rmt.cz](http://www.rmt.cz)

### BRAZIL

**CAPI Controle e Automação Ltda**

Rua Itororó, 121, CEP 13466-240  
Americana-SP, Brazil  
Tel: +55 19 36047068  
Fax: +55 19 34681791  
[capi@capicontrol.com.br](mailto:capi@capicontrol.com.br)  
[www.capicontrol.com.br](http://www.capicontrol.com.br)

### CHILE

**Verne SpA**

Apoquindo 2818, oficina 31,  
Las Condes, Santiago, Chile  
Tel: +56 2 228858633  
[info@verne.cl](mailto:info@verne.cl)  
[jsaavedra@verne.cl](mailto:jsaavedra@verne.cl)  
[www.verne.cl](http://www.verne.cl)

### CHINA

**Zhenshangyou Technologies Co.,Ltd.**

Rm 2205-2210, Zhongyou Hotel  
1110 Nanshan Road, Nanshan  
District 518054 Shenzhen, China  
Tel: +86 755-26528100/8011/8012  
Fax: +86 755-26528210/26435640  
[info@51sensors.com](mailto:info@51sensors.com)  
[www.51sensors.com](http://www.51sensors.com)

### CHINA

**Shanghai micron-metrology com., Ltd.**

Room 602 unit 4, lane 399,  
Mudan road, Pudong New district  
Shanghai, China  
Tel: +86-21-68416510  
[sales@micron-metrology.cn](mailto:sales@micron-metrology.cn)  
[www.micron-metrology.cn](http://www.micron-metrology.cn)

### CHINA

**JRKtech Co., Ltd.**

1F, Building 9, 100 Xianlie Rd.,  
Guangzhou, China  
Tel: +86 755 85267190/  
+86 15989362481  
Fax: + 86 755 85267190  
[shengz\\_k@163.com](mailto:shengz_k@163.com)  
[www.jrktech.com](http://www.jrktech.com)

### CZECH REPUBLIC

**RMT Ltd.**

Zahradni 224  
739 21 Paskov, Czech Republic  
Tel: +420 558640211  
Fax: +420 558640218  
[rmt@rmt.cz](mailto:rmt@rmt.cz)  
[www.rmt.cz](http://www.rmt.cz)

### FINLAND

**TERÄSPYÖRÄ-STEELWHEEL OY**

**RAILWAY INSTRUMENTS ONLY**

Juvan teollisuuskatu 28  
FI-02920 ESPOO, Finland  
Tel: +358 400 422 900  
Fax: +358 9 2511 5510  
[steelwheel@steelwheel.fi](mailto:steelwheel@steelwheel.fi)  
[www.teraspyora.fi](http://www.teraspyora.fi)

### FRANCE

**DB Innovation (ALTHEIS France)**

26, avenue de la Mediterranee  
34110 Frontignan France  
Tel: +33-467786166  
Fax: +33-467740134  
[dbi@altheris.fr](mailto:dbi@altheris.fr)  
[www.altheris.fr](http://www.altheris.fr)

## GERMANY

**Disynet GmbH**  
Breyeller Str. 2  
41379, Brueggen  
Tel: +49 2157 8799-0  
Fax: +49 2157 8799-22  
[disynet@sensoren.de](mailto:disynet@sensoren.de)  
[www.sensoren.de](http://www.sensoren.de)

## GERMANY

**Hylewicz CNC-Technik**  
**SHTRIKH-2 ONLY**  
Siemensstrasse 13-15,  
47608 Geldern, Germany  
Tel: +49 2831 91021-20  
Fax: +49 2831 91021-99  
[info@cnc-step.de](mailto:info@cnc-step.de)  
[www.cnc-step.de](http://www.cnc-step.de)

## INDONESIA

**PT. DHAYA BASWARA**  
**SANIYASA**  
Botanic Junction Blok H-9 NO. 7  
Mega Kebon Jeruk, Joglo  
Jakarta 11640, Indonesia  
Tel: + 62 21 29325859  
[management@ptdbs.co.id](mailto:management@ptdbs.co.id)

## ITALY

**FAE s.r.l.**  
Via Tertulliano, 41  
20137 Milano, Italy  
Tel: +39-02-55187133  
Fax: +39-02-55187399  
[fae@fae.it](mailto:fae@fae.it)  
[www.fae.it](http://www.fae.it)

## NORWAY

**Salitec AS**  
PB 468,  
N-1327 Lysaker  
Tel.: +47 23 891015  
Fax: +47 92101005  
[mail@salitec.no](mailto:mail@salitec.no)  
[www.salitec.no](http://www.salitec.no)

## GERMANY

**BIP-Industrietechnik GmbH**  
**RAILWAY INSTRUMENTS ONLY**  
Am Elisabethhof 22,  
D-14772 Brandenburg  
D-41379 Brueggen, Germany  
Tel: +49 (0) 33 81 75 90 0  
Fax: +49 (0) 33 81 75 90 11  
[info@bip-industrie.de](mailto:info@bip-industrie.de)  
[www.bip-industrietechnik.de](http://www.bip-industrietechnik.de)

## INDIA

**Pragathi Solutions**  
#698, 5th Main, 8th Cross,  
HAL 3rd Stage,  
New Tippasandra Road,  
Bangalore, 560075, India  
Tel: +91 80 32973388  
Tel/fax: +91 80 25293985  
Mobile: +91 9448030426/  
+919448492380  
[sales@pragathisolutions.in](mailto:sales@pragathisolutions.in)  
[arghya@pragathisolutions.in](mailto:arghya@pragathisolutions.in)  
[www.pragathisolutions.in](http://www.pragathisolutions.in)

## IRAN

**Novin Industrial**  
**Development Grp.**  
Tel: +98 21 44022093-6  
Fax: +98 21 43858794  
Mobile: +98 9123207518  
[info@novinid.com](mailto:info@novinid.com)  
[www.novinid.com](http://www.novinid.com)

## LATVIA, ESTONIA

**SIA "SOLARTEX"**  
**RAILWAY INSTRUMENTS ONLY**  
Duntes 15a, 5th floor, office B7  
Riga, Latvia  
Tel.: +371 67 130 787  
[solartex@inbox.lv](mailto:solartex@inbox.lv)

## PERU

**Verne Perú S.A.C.**  
Las Codornices 104,  
Surquillo, Lima, Peru  
Tel/fax: +51 992436734  
[info@verne.cl](mailto:info@verne.cl)  
[www.verne.cl](http://www.verne.cl)

## GERMANY

**Finger GmbH & Co. KG**  
**OPTICAL MICROMETERS ONLY**  
Sapelloh 172,  
31606 Warmssen, Germany  
Tel: +49 5767 96020  
Fax: +49 5767 93004  
[finger@finger-kg.de](mailto:finger@finger-kg.de)  
[www.finger-kg.de](http://www.finger-kg.de)

## INDIA

**Paragon Instrumentation**  
**Engineers Pvt. Ltd.**  
**RAILWAY INSTRUMENTS ONLY**  
200, Station Road,  
Roorkee, 247 667, India  
Tel: +91-1332-272394  
[tanuj@paragoninstruments.com](mailto:tanuj@paragoninstruments.com)  
[www.paragoninstruments.com](http://www.paragoninstruments.com)

## ISRAEL

**Nisso Dekalo Import**  
**Export LTD**  
1 David Hamelech Street  
Herzia 46661 Israel  
Tel: +972-99577888  
Fax: +972-99568860  
[eli@fly-supply.net](mailto:eli@fly-supply.net)  
[www.fly-supply.net](http://www.fly-supply.net)  
[www.aircraft-partsupply.com](http://www.aircraft-partsupply.com)

## MALAYSIA

**OptoCom InstruVentures**  
H-49-2, Jalan 5, Cosmoplex  
Industrial Park, Bandar Baru  
Salak Tinggi, Sepang, Malaysia  
Tel: 603 8706 6806  
Fax: 603 8706 6809  
[optocom@tm.net.my](mailto:optocom@tm.net.my)  
[www.optocom.com.my](http://www.optocom.com.my)

## POLAND

**MTL ASCO Sp. z o.o.**  
**RAILWAY INSTRUMENTS ONLY**  
ul. Wielowiejska 53 44-120  
PYSKOWICE (k/ GLIWIC),  
Poland  
Tel: + 48 32 230 45 70  
Fax: + 48 32 332 70 14  
[rail@ascorail.eu](mailto:rail@ascorail.eu)  
[www.ascorail.eu](http://www.ascorail.eu)

**PORTUGAL****UltraSens**

Qt. da Portela, Lt. 22.1, Ap. 152  
3030 - 502 Coimbra, Portugal  
Phone +351 239 796 277  
Fax: +351 239 918 267  
[info@ultrasens.com](mailto:info@ultrasens.com)  
[www.ultrasens.com](http://www.ultrasens.com)

**SERBIA, SLOVAKIA****RMT Ltd.**

Zahradni 224  
739 21 Paskov, Czech Republic  
Tel: +420 558640211  
Fax: +420 558640218  
[rmt@rmt.cz](mailto:rmt@rmt.cz)  
[www.rmt.cz](http://www.rmt.cz)

**SPAIN****Iberfluid Instruments S.A.**

C/ Botanica, 122  
08908 L'Hospitalet de Llobregat,  
Barcelona  
Tel: +34 93 447 10 65  
Fax: +34 93 334 05 24  
[myct@iberfluid.com](mailto:myct@iberfluid.com)  
[www.iberfluid.com](http://www.iberfluid.com)

**SWEDEN, DENMARK****Latronix AB**

Propellervagen 10,  
183 62 Täby, Sweden  
Tel.: +46 08-446 48 30  
Fax: +46 08-446 48 39  
[sales@latronix.se](mailto:sales@latronix.se)  
[www.latronix.se](http://www.latronix.se)

**UKRAINE****KODA**

Frunze st 22  
61002, Harkov, Ukraine  
Tel/fax: +38 057 714 26 54  
[mail@koda.com.ua](mailto:mail@koda.com.ua)  
[www.koda.com.ua](http://www.koda.com.ua)

**RUSSIA****Sensorika-M LLC**

Dmitrovskoye shosse 64-4  
127474, Moscow, Russia  
Tel: +7 499 487 0363  
Fax: +7 499 487 7460  
[info@sensorika.com](mailto:info@sensorika.com)  
[www.sensorika.com](http://www.sensorika.com)

**SOUTH AFRICA****Ratcom Enterprise Pty Ltd**

CSIR BUILDING 35, Office 78  
Meiring Naude Road, Brummeria  
Pretoria, 0084 South Africa  
Tel: + 27 12 841 2032  
Fax: + 27 86 225 0650  
[info@ratcom.co.za](mailto:info@ratcom.co.za)  
[www.ratcom.co.za](http://www.ratcom.co.za)

**SWITZERLAND****ID&T GmbH**

Gewerbestrasse 12/a  
8132 Egg (Zurich), Switzerland  
Tel: + 41 44 994 92 32  
Fax: + 41 44 994 92 34  
[info@idtlaser.com](mailto:info@idtlaser.com)  
[www.idtlaser.com](http://www.idtlaser.com)

**THAILAND****Advantech Solution Co.,Ltd.**

20/170 Motorway Rd.,  
Kwang Pravet, Khet Pravet,  
Bangkok, Thailand 10250  
Tel: +662-1848705  
Fax: +662-1848708  
[sales@advantechsolution.com](mailto:sales@advantechsolution.com)  
[www.advantechsolution.com](http://www.advantechsolution.com)

**UNITED KINGDOM,  
IRELAND****Ixthus Instrumentation Ltd**

The Stables, Williams' Barns  
Tiffield road, Towcester, Northants  
Tel: +44 1327 353437  
Fax: +44 1327 353564  
[info@ixthus.co.uk](mailto:info@ixthus.co.uk)  
[www.ixthus.co.uk](http://www.ixthus.co.uk)

**RUSSIA****Diesel-test-Komplekt LLC**

620030, Karjernaya St, 16  
Ekaterinburg, Russia  
Tel/fax: +7 343 2227565  
Tel/fax: +7 343 2227370  
[mail@d-test.ru](mailto:mail@d-test.ru)  
[www.d-test.ru](http://www.d-test.ru)

**SOUTH KOREA****PROSEN. CO., LTD**

M-1001, Songdo techno park IT  
center, 32, Songdogwahak-ro,  
Yeonsu-gu, Incheon, 21984,  
Republic of Korea  
Tel: +82-32-811-3457  
Fax: +82-32-232-7458  
[trade@prosen.co.kr](mailto:trade@prosen.co.kr)  
[www.prosen.co.kr](http://www.prosen.co.kr)

**SWEDEN, DENMARK****BLConsult**

Ryssbält 294,  
95 291 KALIX, Sweden  
Mobile: +46 70 663 19 25  
[info@blconsult.se](mailto:info@blconsult.se)  
[www.blconsult.se](http://www.blconsult.se)

**TURKEY****TEKMA Mühendislik A.S.**

Cevizi Mh. M. Kemal Cd.,  
Hukukçular Towers,  
A-Blok, No: 66-A/39  
Kartal – Istanbul  
Tel: +90 216 970 1318  
Tel: +90 850 840 2334  
[info@tekma.eu](mailto:info@tekma.eu)  
[www.tekma.eu](http://www.tekma.eu)

**USA, CANADA, MEXICO****International Electronic  
Machines Corporation**

**RAILWAY INSTRUMENTS ONLY**  
850 River Street, Troy,  
New York, USA  
Tel: +1 518 268-1636  
Fax: +1 518 268-1639  
[marketing@iem.net](mailto:marketing@iem.net)  
[www.iem.net](http://www.iem.net)

USA, CANADA, MEXICO

**Acuity Products of Schmitt Industries, Inc.**

2765 NW Nicolai Street  
Portland, OR, 97210, USA  
Tel: +1 503 227 7908  
Fax: +1 503 223 1258  
[sales@acuitylaser.com](mailto:sales@acuitylaser.com)  
[www.acuitylaser.com](http://www.acuitylaser.com)

61

## 31. RIFTEK's measurement devices for railway transport

### Laser wheel profilometer. IKP Series

A laser profilometer is designed for the measuring of:

- wheel flange height;
- wheel flange thickness;
- wheel flange slope;
- full profile scanning and analyze of wheel rolling surface;
- maintaining of electronic wear data base;
- control of tolerances and sorting in the course of checkup, examination, repair and formation of railway wheel sets.

Measurements are made directly on rolling stock without wheel set roll-out.



### Portable laser rail profilometer. PRP Series

The main functions of PRP are:

- obtaining the information on the cross-section profile of the working railhead surface;
- full profile scanning and analyze of the railhead acting face;
- visualization of the combined graphical images of actual and new cross-section railhead profiles on the display of system unit.



### Wheel diameter measuring gauge. IDK Series

Electronic gauge is designed for measuring wheel rolling circle diameter of railway, metro and tram wheel sets.

Measurements are made directly on rolling stock without wheel set roll-out.





### Back-to-back distance measuring gauge. IMR Series

Gauge is designed for contactless measuring of back-to-back distance of railway, metro and tram wheels in the course of checkup, examination, repair and formation of wheel sets.

Measurements are made directly on rolling stock without wheel set roll-out.



### Back-to-back distance measuring gauge. IMR-L Series

Gauge is designed for contactless measuring of back-to-back distance of railway, metro and tram wheels in the course of checkup, examination, repair and formation of wheel sets.

Measurements are made directly on rolling stock without wheel set roll-out.



### Disc brakes profile gauge, IKD Series

Laser disc brakes profilometer IKD Series is designed for disc brakes profile measuring.

The main functions of IKD are:

- obtaining the information on the profile parameters of the working disc brakes surface;
- full profile scanning and analyze of the disc brakes acting face;
- visualization of the combined graphical images of actual and new disc brakes profiles on the display of system unit.



### Automatic real-time system for measurement of wheelsets geometrical parameters

The system is designed for contactless automatic measurement of geometrical parameters of railway wheels and uses a combination of 2D laser scanners, mounted wayside in the track area.

The system can be easily installed at any type of rail infrastructure.