



Safety. Detection. Control.

SAFEGATE

Access Guarding Made Easy



SAFEGATE 

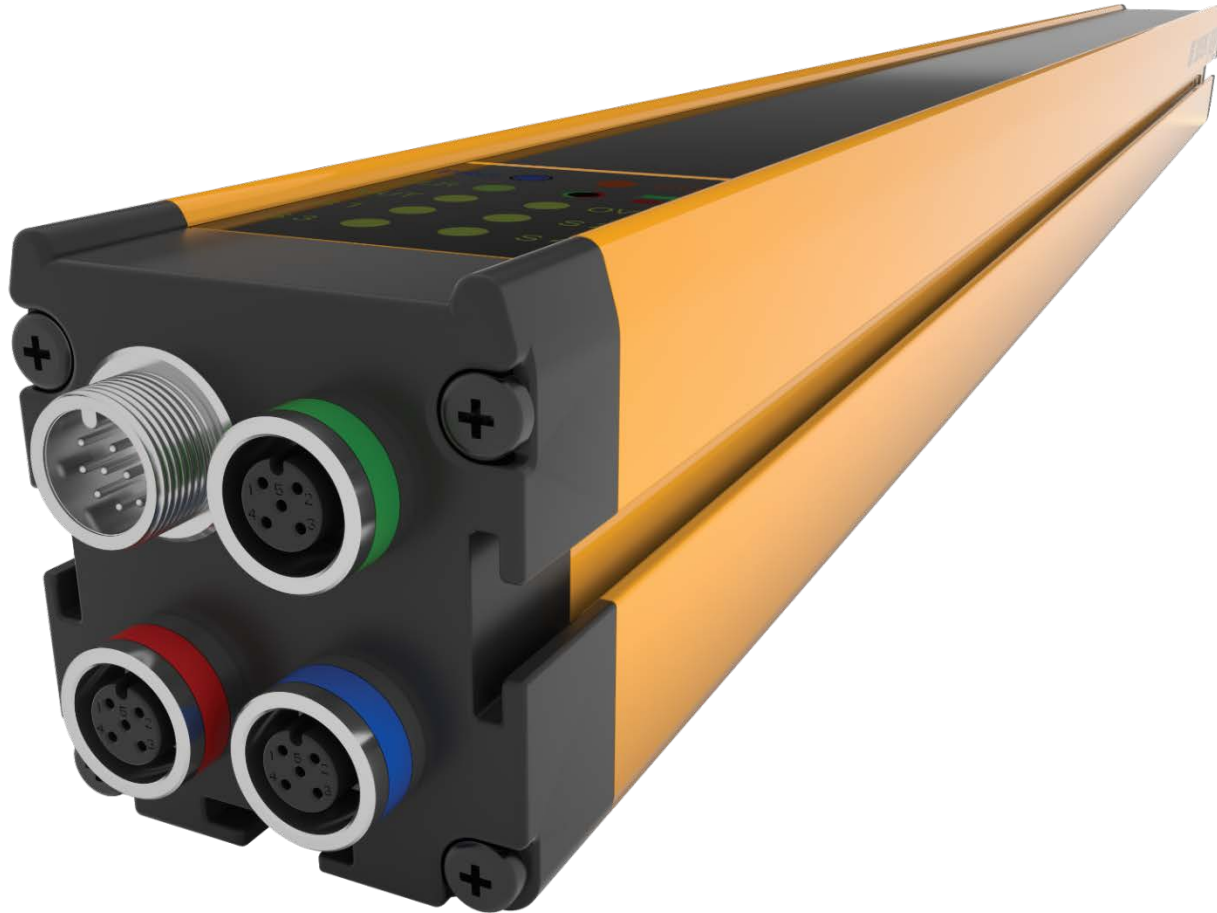

- The new Safegate Type 4 range of access control barriers is the ideal solution for the protection of a vast number of high-risk industrial applications, in particular those requiring a high level of integration of the Muting functions
- Safegate guarantees the perfect integration of all Muting sensors that can be directly connected to the access control barrier

- Flexible configuration
- Hardware or Software configuration to cover all Muting applications
- Pre-configured Muting logics
- Integrated Status and Muting lamp
- Fully scalable
- Change configuration at any time
- Pre-configured and pre-wired Muting arms and Muting brackets
- New M5 multi-beam Muting photocell
- Vast range of accessories including special mounting brackets and floor mounting columns

- Resolutions: 30, 40 mm - 2, 3 and 4 beams
- Emitter / Receiver and Transceiver (passive retro-reflector elements) versions
- Integration of the main safety functions, including self-testing of solid state outputs, external device monitoring (EDM) and Start/Restart interlock function
- Cross-section: 55 x 50 mm
- Protected height: 300 ... 2200 mm
- Protection rating: IP65 and IP67
- Operating temperature: -30 ... +55 °C (without condensing)
- Integrated Status and Muting lamp (SMO/SMPO models)

A unique range

Covering all Muting applications

SM model

- Hardware configuration

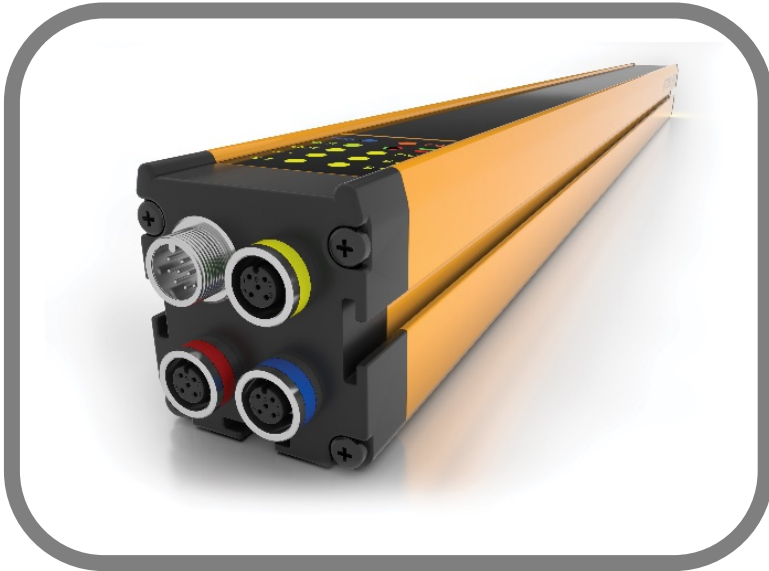

SMO model

- Hardware configuration
- Integrated Status and Muting lamp

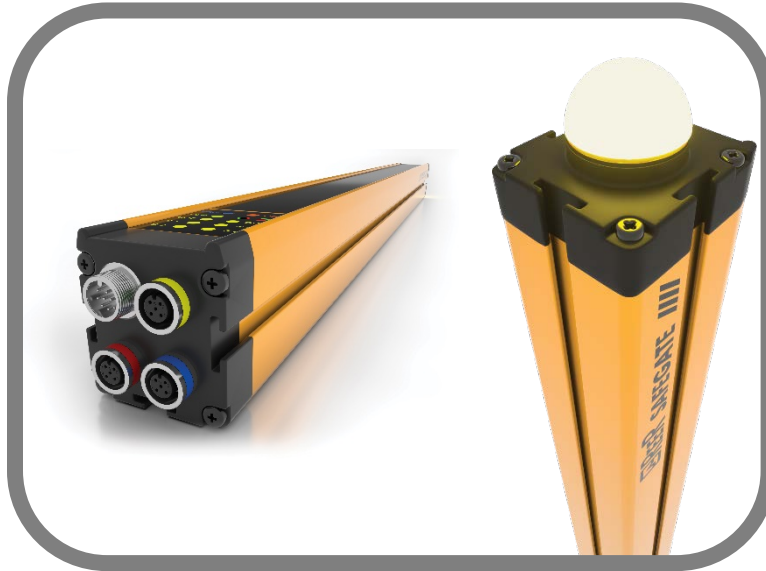

SMPO model

- Hardware or Software configuration
- Integrated Status and Muting lamp

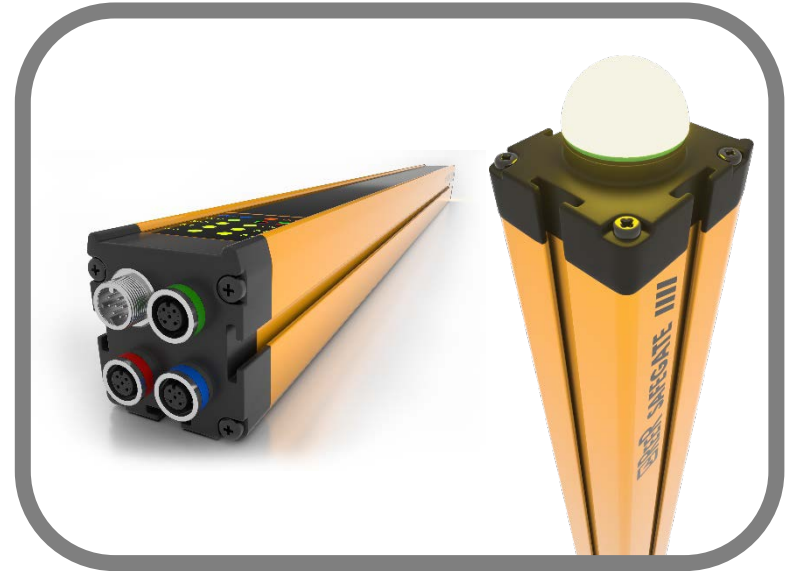

Configuration

- Each barrier can be configured as:
 - Exit-only (L-Muting) with crossed (X) or parallel (P) beams
 - Entry-Exit (T-Muting) with crossed (X) beams
 - Entry-Exit (T-Muting) with parallel (P) beams
- Configuration can be changed at any time

Muting sensors

- Safegate can be used with:
 - MA Muting arms (with pre-aligned and pre-configured integrated Muting sensors)
 - MZ Muting brackets (with M5 multi-beam sensors)
 - Any other external Muting sensor
- Sensors can be upgraded, added or removed at any time

A simple and modular concept

A total solution in 3 steps

1 Choose the barrier model

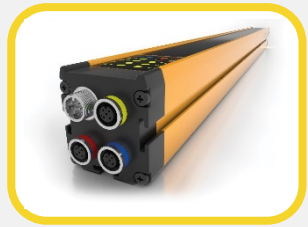

SM

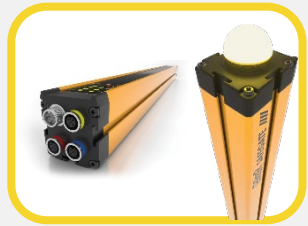

SMO



SMPO

2 Configure the Muting logic

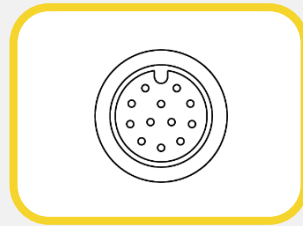

via
Hardware

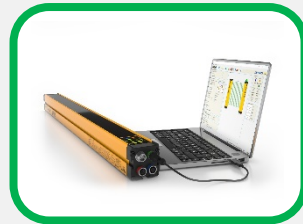

via
Software

Muting options

L2X / T2X / L2P / T4P

3 Choose the Muting sensors



MA



MZ

A unique range

SM model



Characteristics

- Hardware configuration
- Three hardware configuration options, selectable via different Master connector wiring:
 - L2X/P (one-way Muting with 2 crossed/parallel beams sensors)
 - T2X (two-way Muting with 2 crossed beams sensors)
 - T4P (two-way Muting with 4 parallel beams sensors)

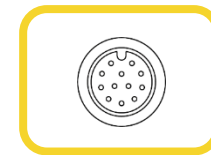

A unique range

SMO model



Characteristics

- Same as SM models
- With integrated Status and Muting lamp

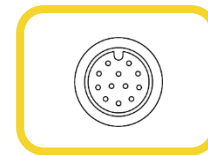

A unique range

SMPO model



Characteristics

- Allows hardware or software configuration of all Muting logics
- Hardware configuration via different main connector wiring (as per SMO models)
- Software configuration via the provided SCS software
- With integrated Status and Muting lamp

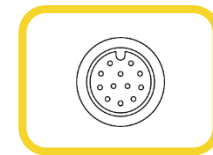

Hardware configuration

- Hardware configurable models (SM/SMO/SMPO) allow configuration of Muting logics and functional parameters via the Master connector wiring

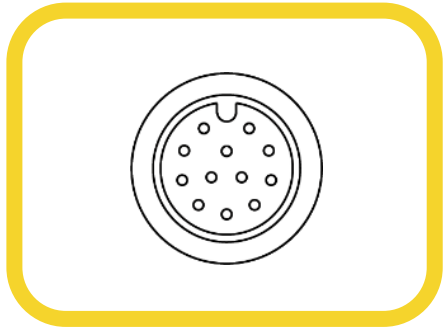

SM/SMO/SMPO models



1. Main connector (M12/12)
- 2a. Auxiliary muting lamp connector (M12/5)
3. Muting sensor connector (M12/5)
4. Muting sensor connector (M12/5)

Software configuration

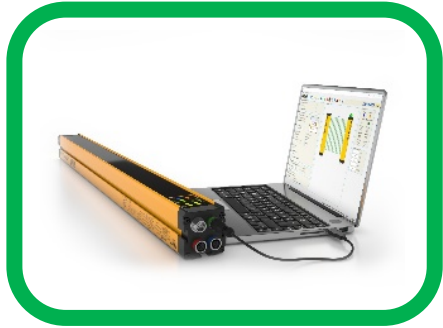

SMPO models



1. Main connector (M12/12)
- 2b. Auxiliary muting lamp and SCS programming connector (M12/5)
3. Muting sensor connector (M12/5)
4. Muting sensor connector (M12/5)

Muting logics are set according to the final application and can be summarised as following:

- **L2X Logic Crossed beams** (One-way, Exit-only)
Suitable solution for any applications with pallet exit
- **L2P Logic Parallel beams** (One-way, Exit-only)
Suitable solution for applications with transparent material: i.e. bottling industry with pallet exit
- **T2X Logic Crossed beams** (Two-way, Entry-Exit)
Suitable solution for the most common pallet infeed/outfeed applications. Ideal solution in case of a continuous flow of pallets even without separation between the pallets
- **T4P Logic Parallel beams** (Two-way, Entry-Exit)
Suitable solution for applications with transparent material and application with presence of a pallet with reduced width or not systematically centred on the conveyor

Muting logics

L2X Logic Crossed beams

Suitable solution for any applications with pallet exit

- One-way
- Exit-only
- L logic
- Crossed beams

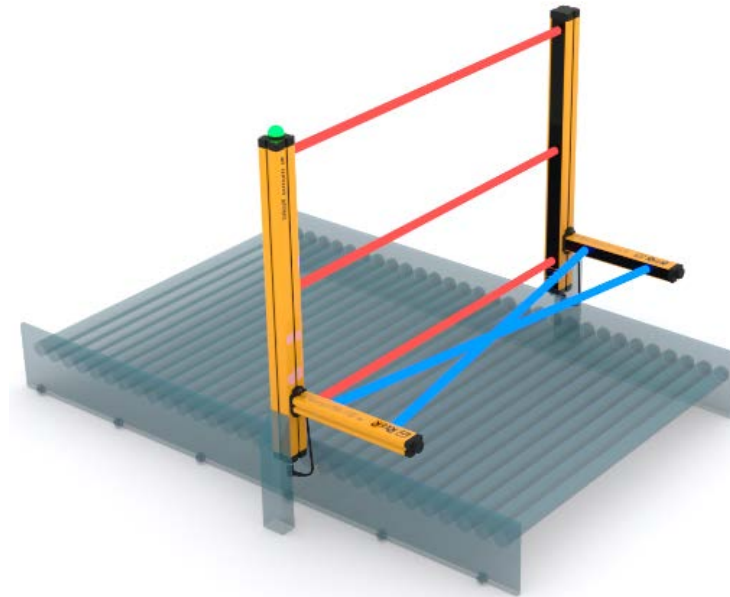

- Max. time between the 2 Muting activation signals: 4 sec.
- Possibility to use with photocells, proximity sensors, and limit switches
- Operative range:
 - 1 ... 2,5 m (MA)
 - 0 ... 3,5 m (MZ)
- Muting sensor elements adjustable in height and angle
- Max. Muting time-out time: 30 sec. or 9 hours selectable
- Muting enable input available

Muting logics

L2P Logic Parallel beams

Suitable solution for applications with transparent material: i.e. bottling industry with pallet exit

- One-way
- Exit-only
- L logic
- Parallel beams

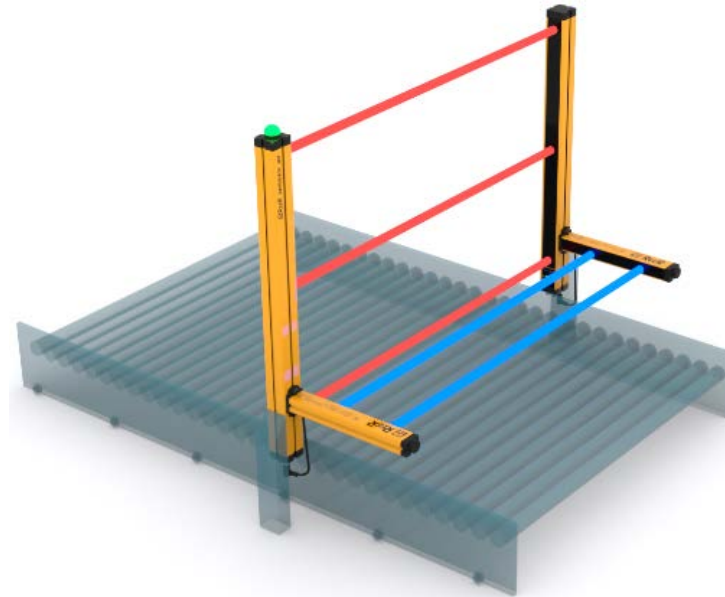

- Max. time between the 2 Muting activation signals: 4 sec.
- Possibility to use with photocells, proximity sensors, and limit switches
- Operative range:
 - 0 ... 3,5 m (MA TRX and MZ)
 - 0 ... 2 m (MA TRX G)
- Muting sensor elements adjustable in height and angle
- Max. Muting time-out time: 30 sec. or 9 hours selectable
- Muting enable input available

Muting logics

T2X Logic Crossed beams

Suitable solution for the most common pallet infeed/outfeed applications. Ideal solution in case of a continuous flow of pallets even without separation between the pallets

- Two-way
- Entry-Exit
- T logic
- Crossed beams

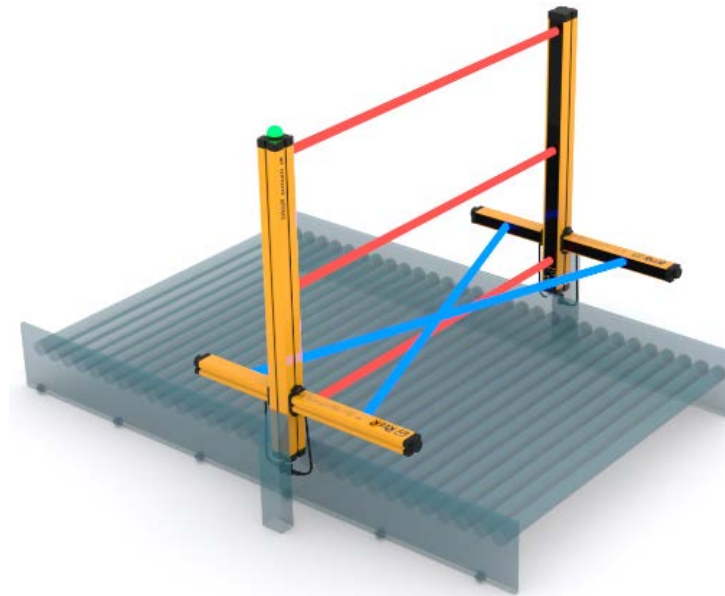

- Max. time between the 2 Muting activation signals: 4 sec.
- Possibility to use with photocells, proximity sensors, and limit switches
- Operative range:
 - 1 ... 2,5 m (MA)
 - 0 ... 3,5 m (MZ)
- Muting sensor elements adjustable in height and angle
- Max. Muting time-out time: 30 sec. or 9 hours selectable
- Muting enable input available

Muting logics

T4P Logic Parallel beams

Suitable solution for applications with transparent material and application with presence of a pallet with reduced width or not systematically centred on the conveyor

- Two-way
- Entry-Exit
- T logic
- Parallel beams

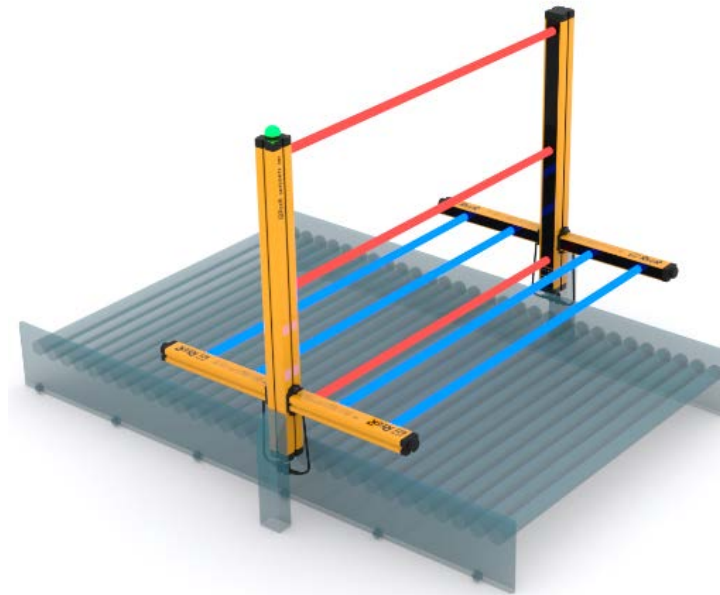

- Max. time between the 2 Muting activation signals: 4 sec.
- Possibility to use with photocells, proximity sensors, and limit switches
- Operative range:
 - 0 ... 3,5 m (MA TRX and MZ)
 - 0 ... 2 m (MA TRX G)
- Muting sensor elements adjustable in height and angle
- Max. Muting time-out time: 30 sec., 9 hours or infinite selectable
- Muting enable input available

Characteristics

- Muting arms with integrated sensors
- Pre-wired
- Pre-aligned

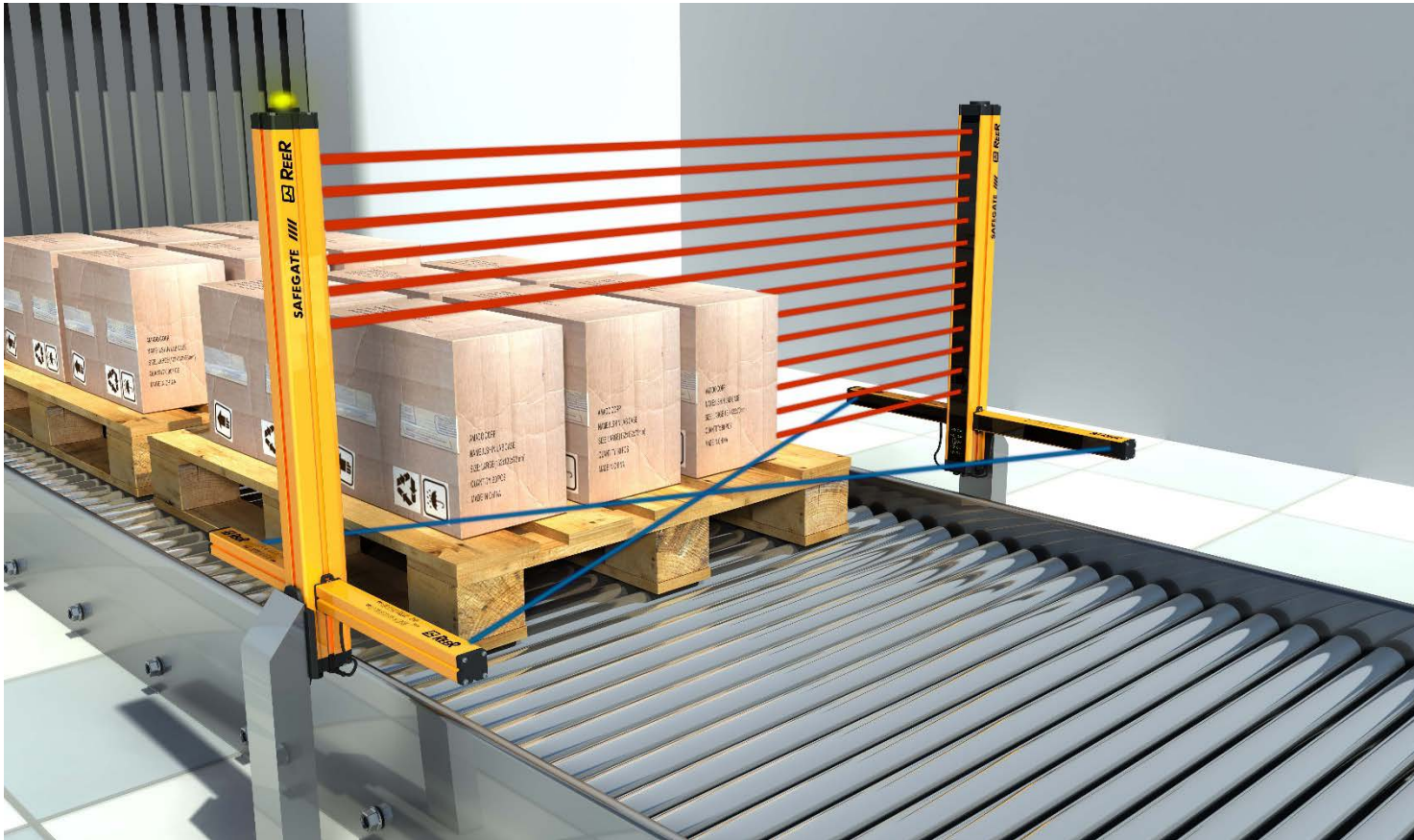

Muting sensors

MA Muting arms

Example



Available kits

- MA L2X arms (2 through-beam sensors)
 - One-way Muting logic (crossed beams)
- MA L2P TRX arms (2 retro-reflective sensors)
 - One-way Muting logic (parallel beams)
- MA T2X arms (2 through-beam sensors)
 - Two-way Muting logic (crossed beams)
- MA T4P TRX arms (4 retro-reflective sensors)
 - Two-way Muting logic (parallel beams)

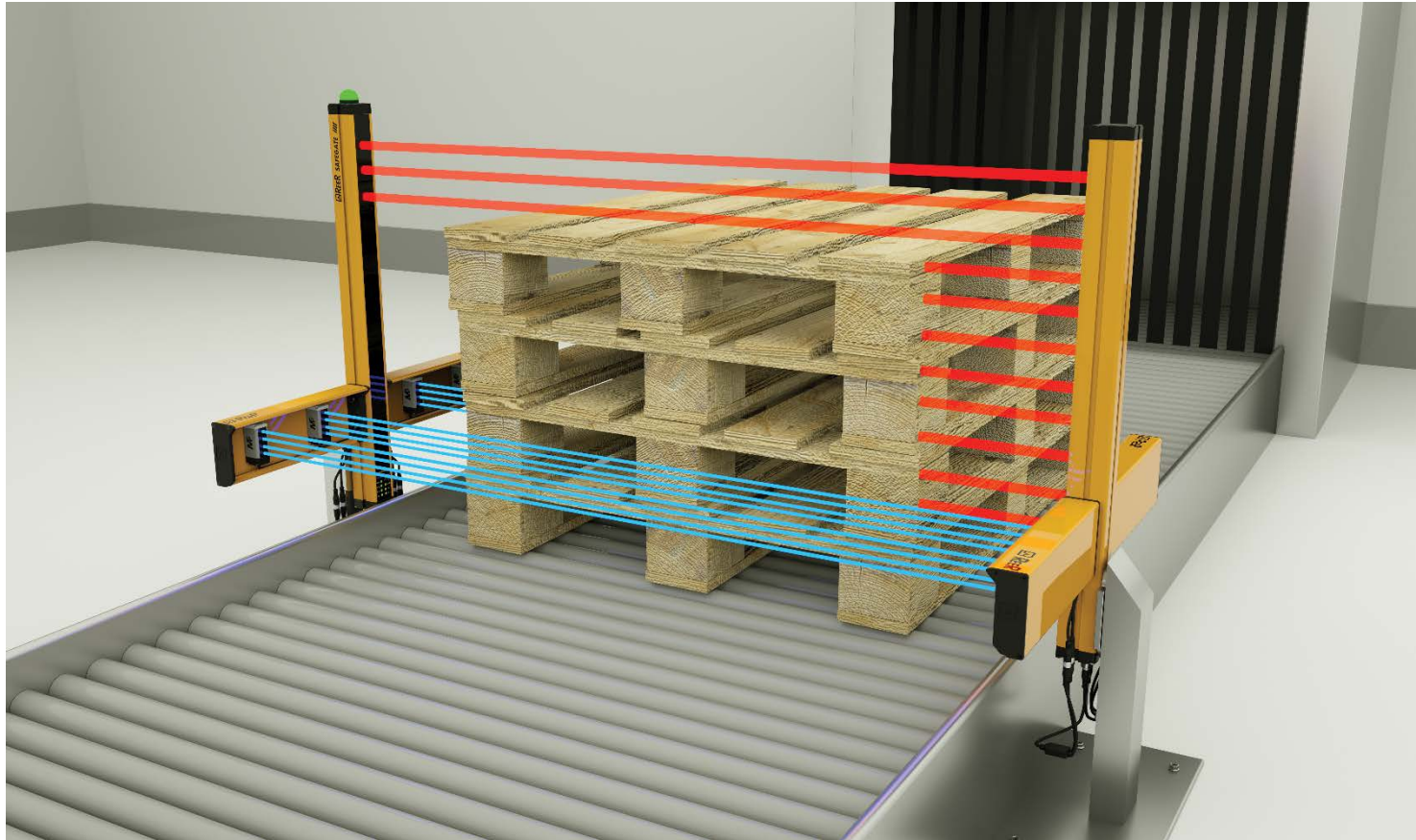

Characteristics

- Muting brackets with M5 photocells
- Pre-wired
- Pre-aligned



Muting sensors

MZ Muting brackets

Example



Available kits

- MZ L2XP brackets (with 2 M5 multi-beam sensors)
 - One-way Muting logic (crossed beams)
 - One-way Muting logic (parallel beams)
- MZ T2X brackets (with 2 M5 multi-beam sensors)
 - Two-way Muting logic (crossed beams)
- MZ T4P brackets (with 4 M5 multi-beam sensors)
 - Two-way Muting logic (parallel beams)

Muting logics

L2X Logic Crossed beams

Suitable solution for any applications with pallet exit

- One-way
- Exit-only
- L logic
- Crossed beams

With MA arms

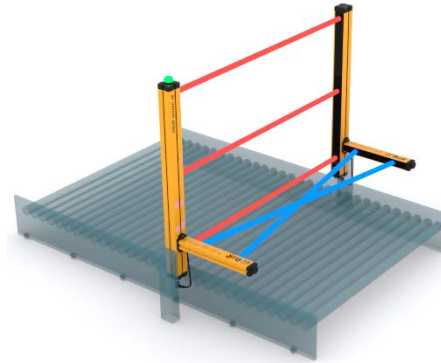

MA L2X

- 2 integrated sensors (Emitter-Receiver)

With MZ brackets

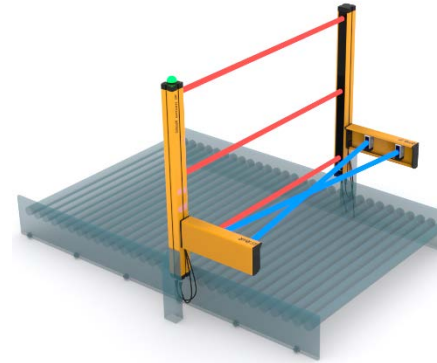

MZ L2XP

- 2 M5 multi-beam sensors

With external photocells

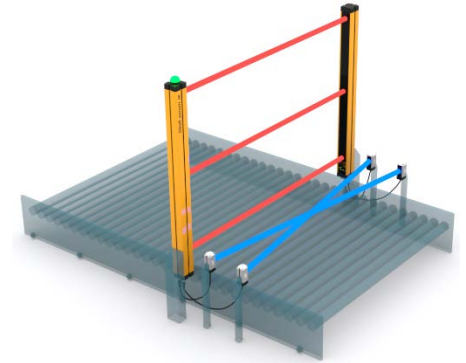

M5 or external photocells

- 2 external sensors (i.e. M⁵ multi-beam sensors or photocells)

Muting logics

L2P Logic Parallel beams

Suitable solution for applications with transparent material: i.e. bottling industry with pallet exit

- One-way
- Exit-only
- L logic
- Parallel beams

With MA arms

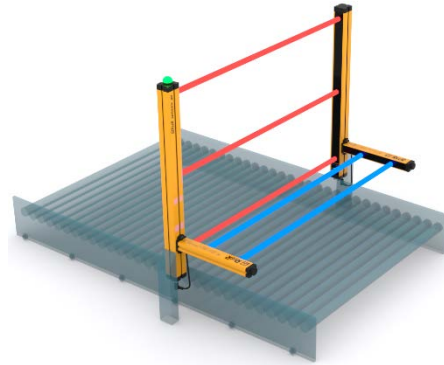

MA L2P TRX

- 2 integrated sensors (Transceiver)

With MZ brackets

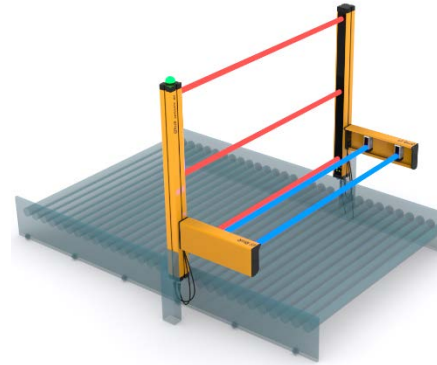

MZ L2XP

- 2 M5 multi-beam sensors

With external photocells

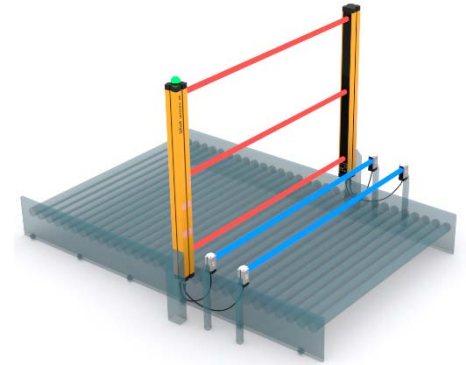

M5 or external photocells

- 2 external sensors (i.e. M⁵ multi-beam sensors or photocells)

Muting logics

T2X Logic Crossed beams

Suitable solution for the most common pallet infeed/outfeed applications. Ideal solution in case of a continuous flow of pallets even without separation between the pallets

- Two-way
- Entry-Exit
- T logic
- Crossed beams

With MA arms

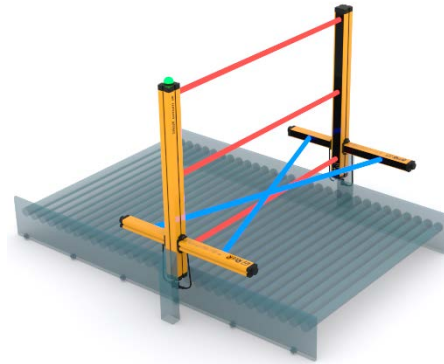

MA T2X

- 2 integrated sensors (Emitter-Receiver)

With MZ brackets

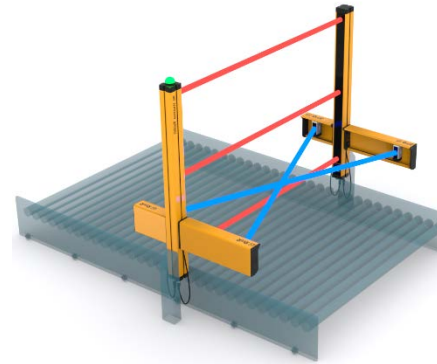

MZ T2X

- 2 M5 multi-beam sensors

With external photocells

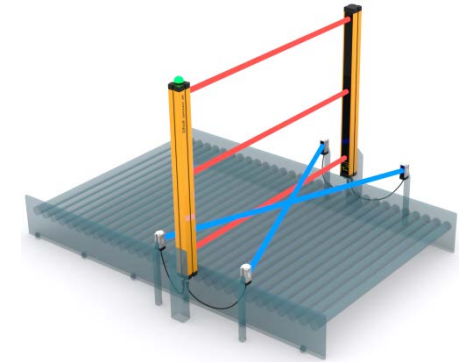

M5 or external photocells

- 2 external sensors (i.e. M⁵ multi-beam sensors or photocells)

Muting logics

T4P Logic Parallel beams

Suitable solution for applications with transparent material and application with presence of a pallet with reduced width or not systematically centred on the conveyor

- Two-way
- Entry-Exit
- T logic
- Parallel beams

With MA arms

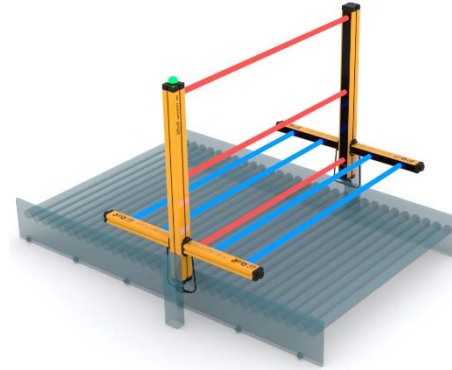

MA T4P TRX

- 4 integrated sensors (Transceiver)

With MZ brackets

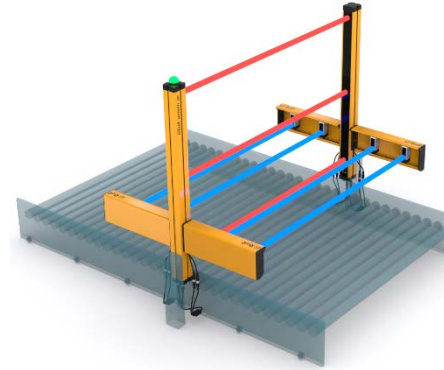

MZ T4P

- 4 M5 multi-beam sensors

With external photocells

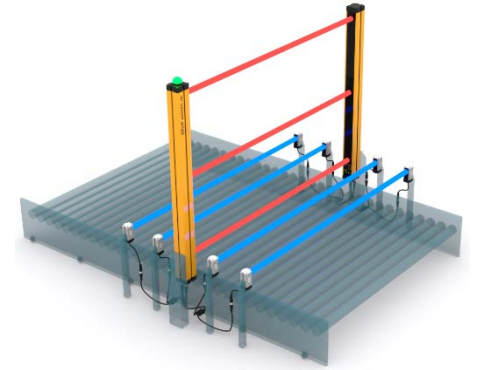

M5 or external photocells

- 4 external sensors (i.e. M⁵ multi-beam sensors or photocells)

Integrated Status lamp

SMO/SMPO models

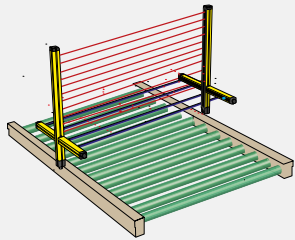

GUARD

Light curtain in Normal condition

Standard operations in progress

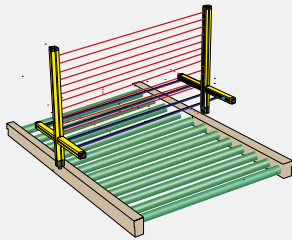

Flashing

CLEAR

Waiting for Restart

Clear light curtain with not restored outputs

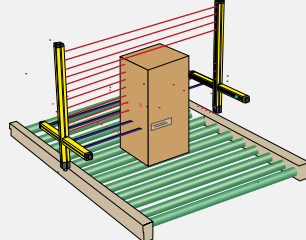

MUTING

Light curtain in Muting condition

Muting sensors have been activated and the barrier has been temporarily disabled. Once the muting condition stops, the barrier will resume standard operations

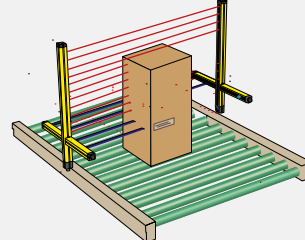

Flashing

OVERRIDE REQUEST

Barrier occupied waiting for an override

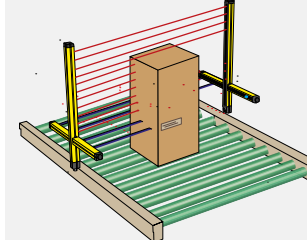

OVERRIDE

Light curtain in Override condition

Override function is activated to clear access points from any obstacle interrupting the barrier beams accidentally

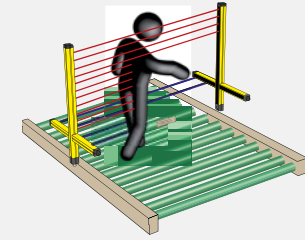

BREAK

Light curtain beam interrupted

At least one beam has been interrupted

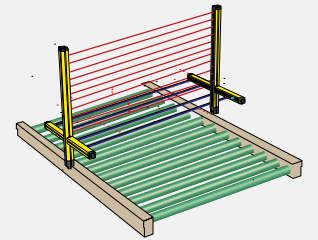

Flashing

FAIL

Light curtain in error condition

Waiting for the operator to perform a restart to resume standard operations

M5 Multi-beam photocell

Through-beam barrier type photocell with 5 beams

Characteristics

- Ideal for installation as Muting sensor, allows to detect also the most difficult objects like, for example, piles of pallets
- With a compact metal housing and a polycarbonate protective front window, it offers the right degree of robustness ideal also in the most demanding environments
- Provided with 90 cm cable with M12 5-pole connector for easy installation
- The integrated status signalling lamp allows to easily verify the status of the system





- Floor mounting columns (allow MZ Muting arms or MZ Muting brackets to be installed directly on the side of the columns)
- MJ BOX, connection box
- Cables
- Spares



Safety. Detection. Control.

Thank you.