

Single IGBT Module 600 Amperes/1700 Volts

Note: All electrical characteristics scaled from 300A module CM300DX-34SA.

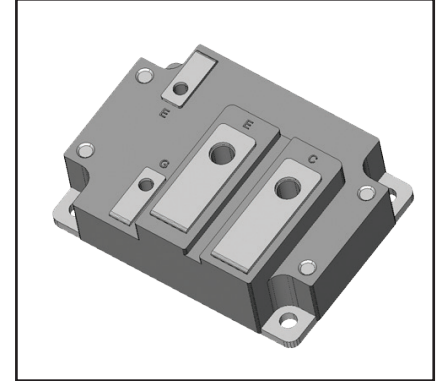
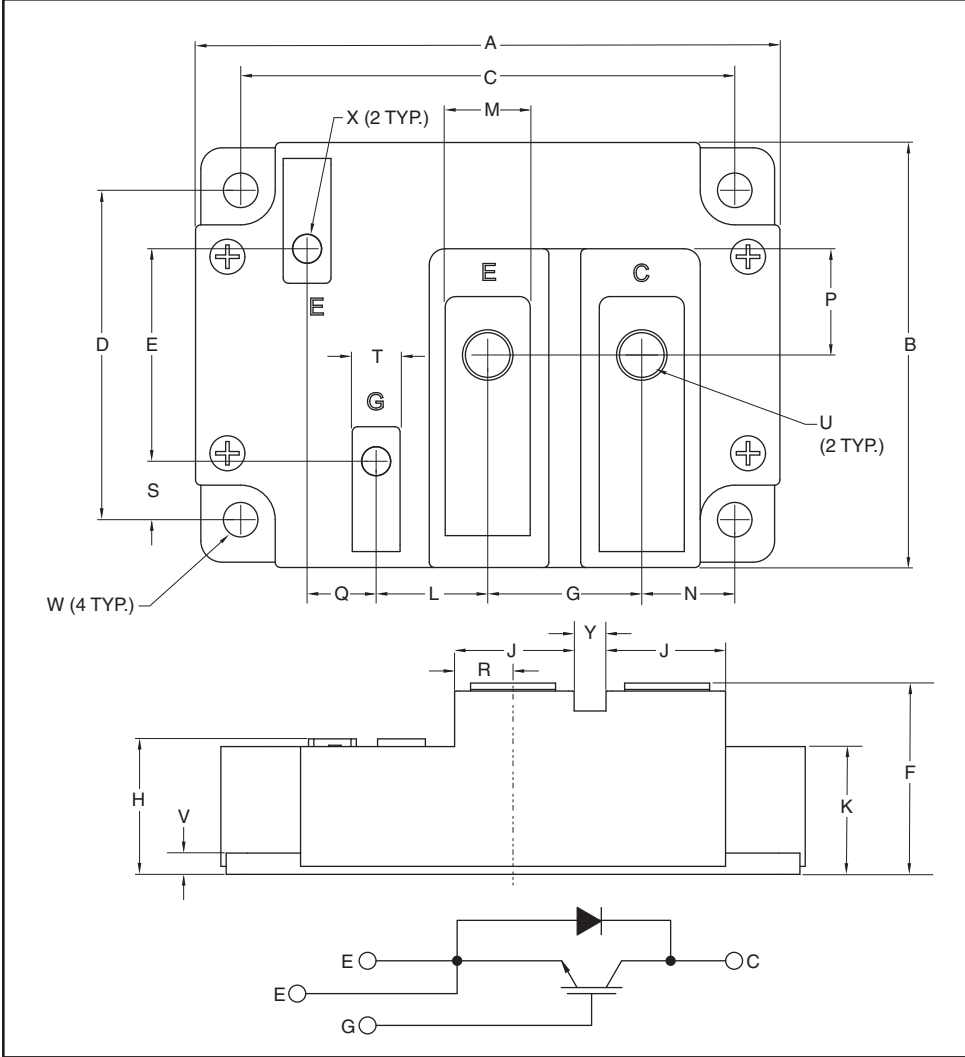

Description:

Powerex IGBT Modules are designed for use in switching applications. Each module consists of one IGBT Transistor in a single configuration with a reverse-connected super-fast recovery free-wheel diode. All components and interconnects are isolated from the heat sinking baseplate, offering simplified system assembly and thermal management.

Features:

- Low Drive Power
- Low $V_{CE(sat)}$
- Discrete Super-Fast Recovery Free-Wheel Diode
- Isolated Baseplate for Easy Heat Sinking

Applications:

- AC Motor Control
- Motion/Servo Control
- UPS
- Welding Power Supplies
- Laser Power Supplies

Outline Drawing and Circuit Diagram

Dimensions	Inches	Millimeters
A	4.33	110.0
B	3.15	80.0
C	3.66±0.008	93.0±0.25
D	2.44±0.008	62.0±0.25
E	1.57	40.0
F	1.42 Max.	36.0 Max.
G	1.14	29.0
H	1.00 Max.	25.5 Max.
J	0.89	22.5
K	0.93	23.5
L	0.83	21.0
M	0.63	16.0

Dimensions	Inches	Millimeters
N	0.69	17.5
P	0.79	20.0
Q	0.51	13.0
R	0.43	11.0
S	0.43	11.0
T	0.35	9.0
U	M8 Metric	M8
V	0.16	4.0
W	0.256 Dia.	6.5 Dia.
X	M4 Metric	M4
Y	0.24	6.0

QIS1760002
Single IGBT Module
 600 Amperes/1700 Volts

Absolute Maximum Ratings, $T_j = 25^\circ\text{C}$ unless otherwise specified

Characteristics	Symbol	Rating	Units
Collector-Emitter Voltage ($V_{GE} = 0\text{V}$)	V_{CES}	1700	Volts
Gate-Emitter Voltage ($V_{CE} = 0\text{V}$)	V_{GES}	± 20	Volts
Collector Current (DC, $T_C = \text{TBD}^\circ\text{C}$)*2,*4	I_C	600	Amperes
Collector Current (Pulse, Repetitive)*3	I_{CRM}	1200	Amperes
Total Power Dissipation ($T_C = 25^\circ\text{C}$)*2,*4	P_{tot}	4660	Watts
Emitter Current ($T_C = \text{TBD}^\circ\text{C}$)*2,*4	I_E^{*1}	600	Amperes
Emitter Current (Pulse, Repetitive)*3	I_{ERM}^{*1}	1200	Amperes
Maximum Junction Temperature	$T_{j(\max)}$	175	$^\circ\text{C}$
Maximum Case Temperature*2	$T_{C(\max)}$	125	$^\circ\text{C}$
Operating Junction Temperature	$T_{j(\text{op})}$	-40 to +150	$^\circ\text{C}$
Storage Temperature	T_{stg}	-40 to +125	$^\circ\text{C}$
Isolation Voltage (Terminals to Baseplate, RMS, $f = 60\text{Hz}$, AC 1 minute)	V_{ISO}	3500	Volts

*1 Represent ratings and characteristics of the anti-parallel, emitter-to-collector free wheeling diode (FWDI).

*2 Case temperature (T_C) and heatsink temperature (T_S) is measured on the surface (mounting side) of the baseplate and the heatsink side just under the chips. The heatsink thermal resistance should be measured just under the chips.

*3 Pulse width and repetition rate should be such that device junction temperature (T_j) does not exceed $T_{j(\max)}$ rating.

*4 Junction temperature (T_j) should not increase beyond maximum junction temperature ($T_{j(\max)}$) rating.

QIS1760002
Single IGBT Module
 600 Amperes/1700 Volts

Electrical Characteristics, $T_j = 25^\circ\text{C}$ unless otherwise specified

Characteristics	Symbol	Test Conditions	Min.	Typ.	Max.	Units
Collector-Emitter Cutoff Current	I_{CES}	$V_{CE} = V_{CES}, V_{GE} = 0V$	—	—	2	mA
Gate-Emitter Leakage Current	I_{GES}	$V_{GE} = V_{GES}, V_{CE} = 0V$	—	—	1.0	μA
Gate-Emitter Threshold Voltage	$V_{GE(th)}$	$I_C = 60\text{mA}, V_{CE} = 10V$	5.4	6.0	6.6	Volts
Collector-Emitter Saturation Voltage	$V_{CE(sat)}$	$I_C = 600\text{A}, V_{GE} = 15V, T_j = 25^\circ\text{C}^{*6}$	—	2.0	2.5	Volts
		$I_C = 600\text{A}, V_{GE} = 15V, T_j = 125^\circ\text{C}^{*6}$	—	2.2	—	Volts
		$I_C = 600\text{A}, V_{GE} = 15V, T_j = 150^\circ\text{C}^{*6}$	—	2.25	—	Volts
Input Capacitance	C_{ies}		—	—	104	nF
Output Capacitance	C_{oes}	$V_{CE} = 10V, V_{GE} = 0V$	—	—	4.4	nF
Reverse Transfer Capacitance	C_{res}		—	—	1.04	nF
Gate Charge	Q_G	$V_{CC} = 1000V, I_C = 600A, V_{GE} = 15V$	—	3312	—	nC
Turn-on Delay Time	$t_{d(on)}$		—	TBD	—	ns
Rise Time	t_r	$V_{CC} = 1000V, I_C = 600A, V_{GE} = \pm 15V,$	—	TBD	—	ns
Turn-off Delay Time	$t_{d(off)}$	$R_G = 0\Omega, \text{ Inductive Load}$	—	TBD	—	ns
Fall Time	t_f		—	TBD	—	ns
Emitter-Collector Voltage	V_{EC}^{*1}	$I_E = 600A, V_{GE} = 0V, T_j = 25^\circ\text{C}^{*6}$	—	4.1	5.3	Volts
		$I_E = 600A, V_{GE} = 0V, T_j = 125^\circ\text{C}^{*6}$	—	2.9	—	Volts
		$I_E = 600A, V_{GE} = 0V, T_j = 150^\circ\text{C}^{*6}$	—	2.7	—	Volts
Reverse Recovery Time	t_{rr}^{*1}	$V_{CC} = 1000V, I_E = 600A, V_{GE} = \pm 15V$	—	—	300	ns
Reverse Recovery Charge	Q_{rr}^{*1}	$R_G = 0\Omega, \text{ Inductive Load}$	—	28	—	μC
Turn-on Switching Energy per Pulse	E_{on}	$V_{CC} = 1000V, I_C = I_E = 600A,$	—	76	—	mJ
Turn-off Switching Energy per Pulse	E_{off}	$V_{GE} = \pm 15V, R_G = 0\Omega,$	—	160	—	mJ
Reverse Recovery Energy per Pulse	E_{rr}^{*1}	$T_j = 150^\circ\text{C}, \text{ Inductive Load}$	—	138	—	mJ
Internal Lead Resistance	$R_{CC} + EE'$	Main Terminals-Chip, $T_C = 25^\circ\text{C}^{*2}$	—	—	TBD	m Ω
Internal Gate Resistance	r_g		—	0.85	—	Ω

*1 Represent ratings and characteristics of the anti-parallel, emitter-to-collector free wheeling diode (FWDI).

*2 Case temperature (T_C) and heatsink temperature (T_S) is measured on the surface (mounting side) of the baseplate and the heatsink side just under the chips. The heatsink thermal resistance should be measured just under the chips.

*6 Pulse width and repetition rate should be such as to cause negligible temperature rise.

QIS1760002
Single IGBT Module
 600 Amperes/1700 Volts

Electrical Characteristics, $T_j = 25^\circ\text{C}$ unless otherwise specified (continued)

Thermal Resistance Characteristics

Characteristics	Symbol	Test Conditions	Min.	Typ.	Max.	Units
Thermal Resistance, Junction to Case ^{*2}	$R_{th(j-c)Q}$	Per Inverter IGBT	—	26.8	—	K/kW
Thermal Resistance, Junction to Case ^{*2}	$R_{th(j-c)D}$	Per Inverter FWDi	—	37.9	—	K/kW
Contact Thermal Resistance, Case to Heatsink ^{*2}	$R_{th(c-f)}$	Thermal Grease Applied	—	15	—	K/kW

Mechanical Characteristics

Mounting Torque		Mounting to Terminal, M8 Screw	—	—	95	in-lb
		Mounting to Terminal, M4 Screw	—	—	15	in-lb
		Mounting to Heatsink, M6 Screw	—	—	40	in-lb
Creepage Distance	d_s	Terminal to Terminal	18	—	—	mm
		Terminal to Baseplate	20	—	—	mm
Clearance	d_a	Terminal to Terminal	13	—	—	mm
		Terminal to Baseplate	20	—	—	mm
Weight	m		—	600	—	Grams
Flatness of Baseplate	e_c	On Centerline X, Y	-100	—	+100	μm

Recommended Operating Conditions, $T_a = 25^\circ\text{C}$

(DC) Supply Voltage	V_{CC}	Applied Across C-E	—	1000	1200	Volts
Gate (-Emitter Drive) Voltage	$V_{GE(on)}$	Applied Across G-E	13.5	15.0	16.5	Volts
External Gate Resistance	R_G	Per Switch	0	—	13.5	Ω

^{*2} Case temperature (T_C) and heatsink temperature (T_S) is measured on the surface (mounting side) of the baseplate and the heatsink side just under the chips. The heatsink thermal resistance should be measured just under the chips.

QIS1760002
 Single IGBT Module
 600 Amperes/1700 Volts

**OUTPUT CHARACTERISTICS
 (CHIP - TYPICAL)**

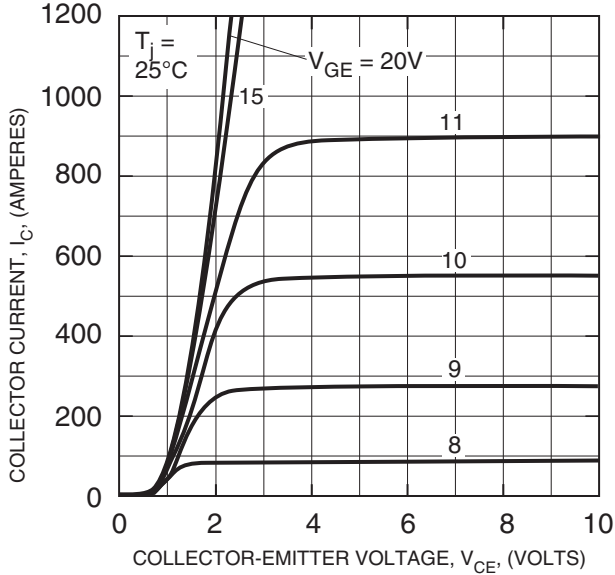

**COLLECTOR-EMITTER
 SATURATION VOLTAGE CHARACTERISTICS
 (CHIP - TYPICAL)**

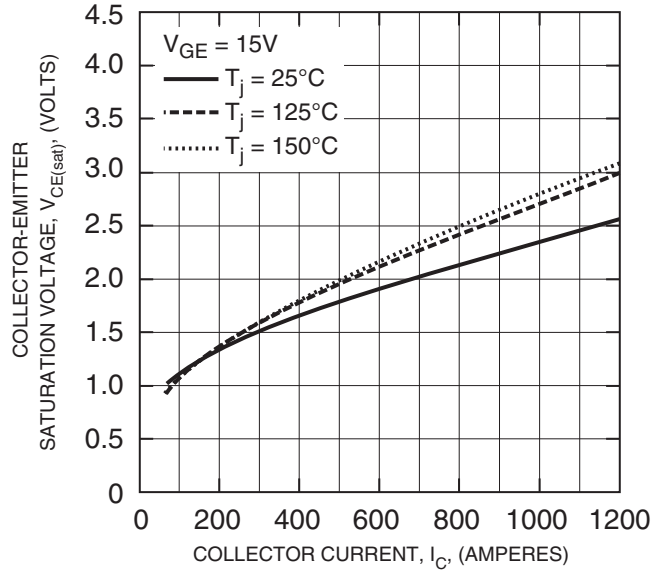

**COLLECTOR-EMITTER
 SATURATION VOLTAGE CHARACTERISTICS
 (CHIP - TYPICAL)**

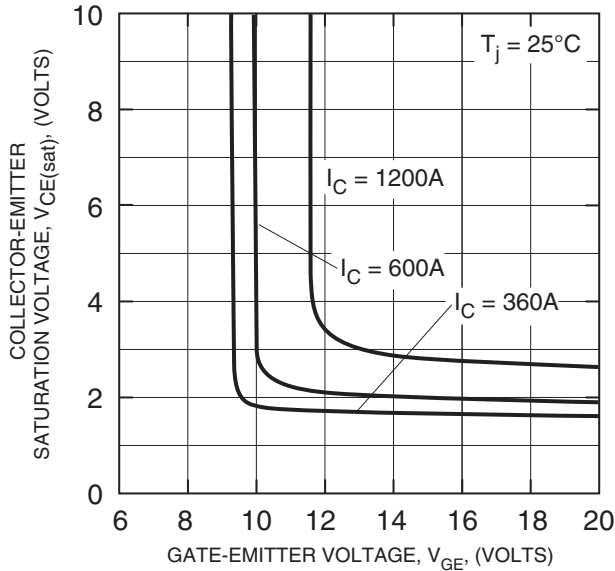

**FREE-WHEEL DIODE
 FORWARD CHARACTERISTICS
 (CHIP - TYPICAL)**

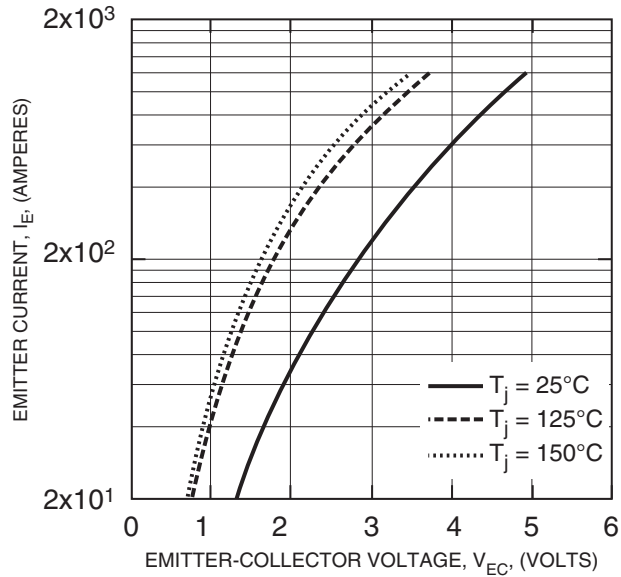

Information presented is based upon manufacturers testing and projected capabilities. This information is subject to change without notice. The manufacturer makes no claim as to the suitability of use, reliability, capability, or future availability of this product.

QIS1760002
Single IGBT Module
 600 Amperes/1700 Volts

CAPACITANCE VS. V_{CE}
 (TYPICAL)

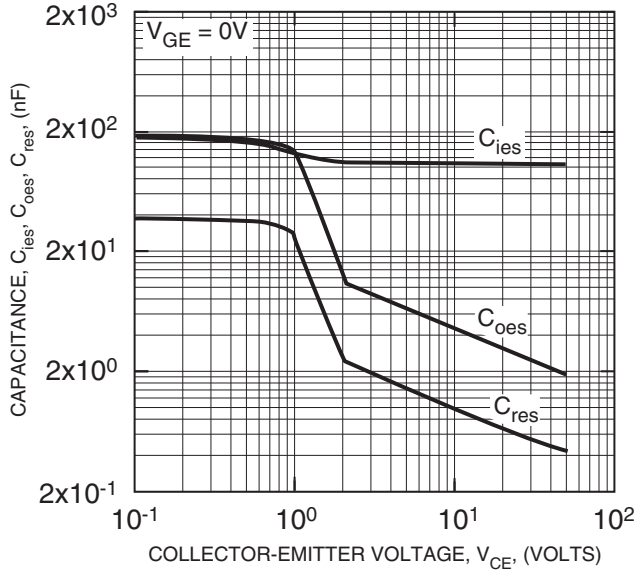

HALF-BRIDGE SWITCHING CHARACTERISTICS
 (TYPICAL)

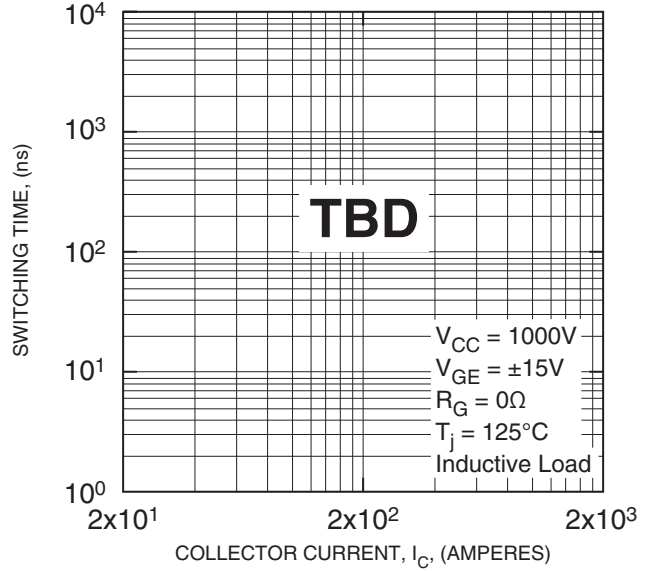

HALF-BRIDGE SWITCHING CHARACTERISTICS
 (TYPICAL)

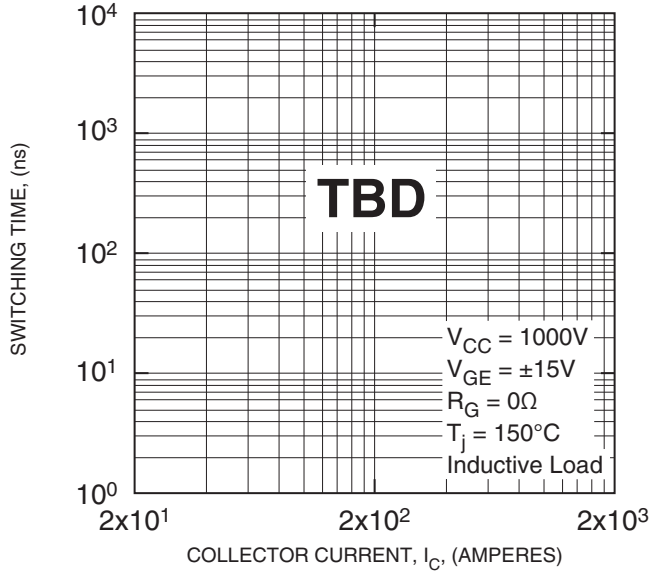

SWITCHING TIME VS. GATE RESISTANCE
 (TYPICAL)

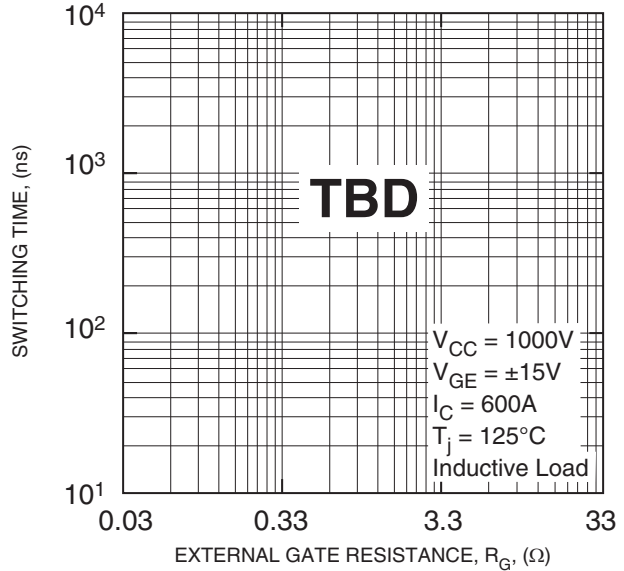

Information presented is based upon manufacturers testing and projected capabilities. This information is subject to change without notice. The manufacturer makes no claim as to the suitability of use, reliability, capability, or future availability of this product.

QIS1760002
 Single IGBT Module
 600 Amperes/1700 Volts

REVERSE RECOVERY CHARACTERISTICS (TYPICAL)

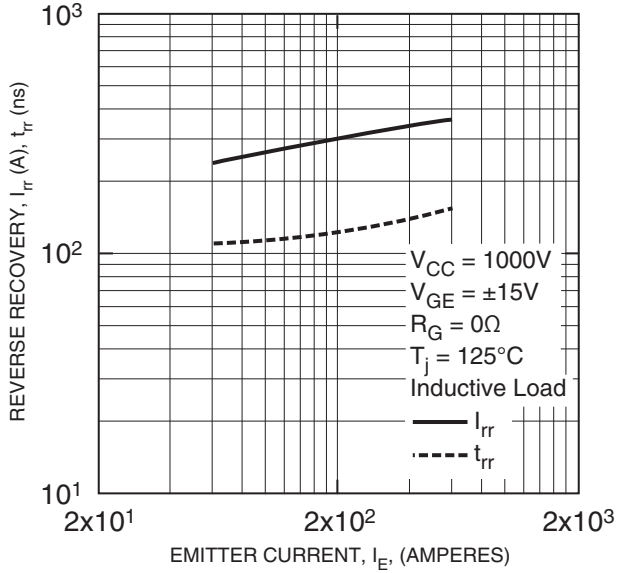

REVERSE RECOVERY CHARACTERISTICS (TYPICAL)

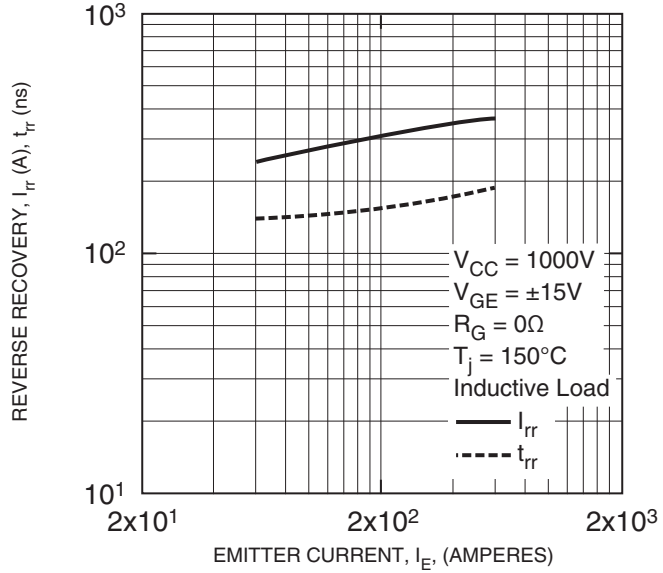

GATE CHARGE VS. V_{GE} (TYPICAL)

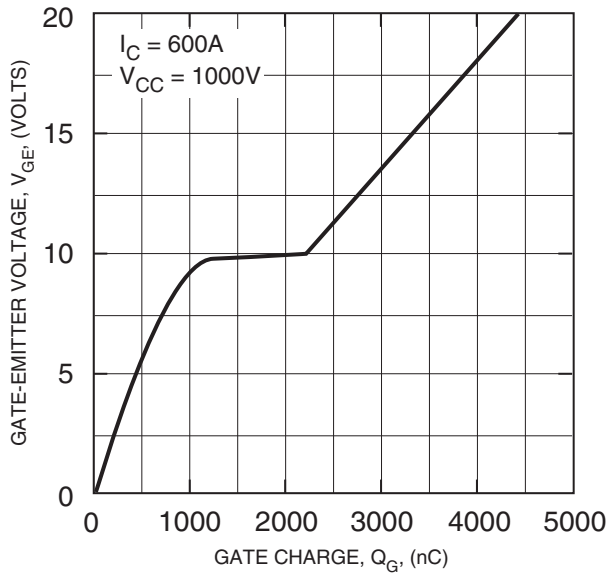

HALF-BRIDGE SWITCHING CHARACTERISTICS (TYPICAL)

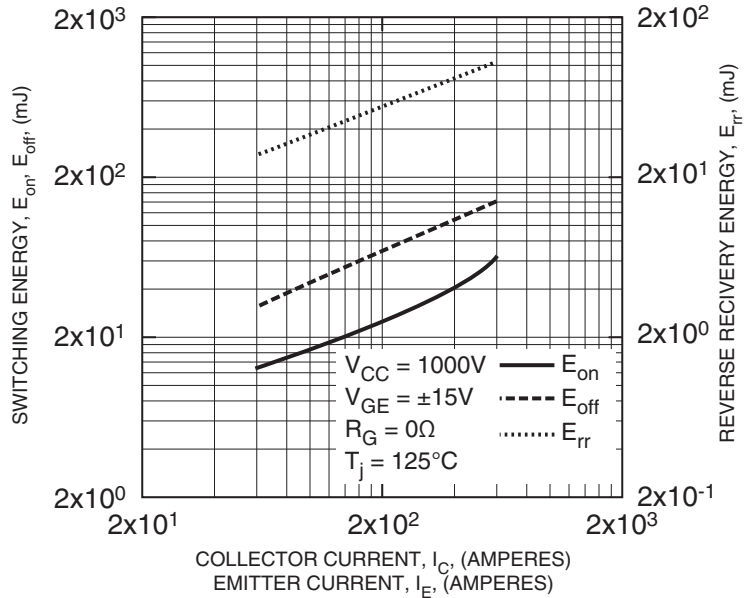

Information presented is based upon manufacturers testing and projected capabilities. This information is subject to change without notice. The manufacturer makes no claim as to the suitability of use, reliability, capability, or future availability of this product.

QIS1760002
 Single IGBT Module
 600 Amperes/1700 Volts

HALF-BRIDGE SWITCHING CHARACTERISTICS (TYPICAL)

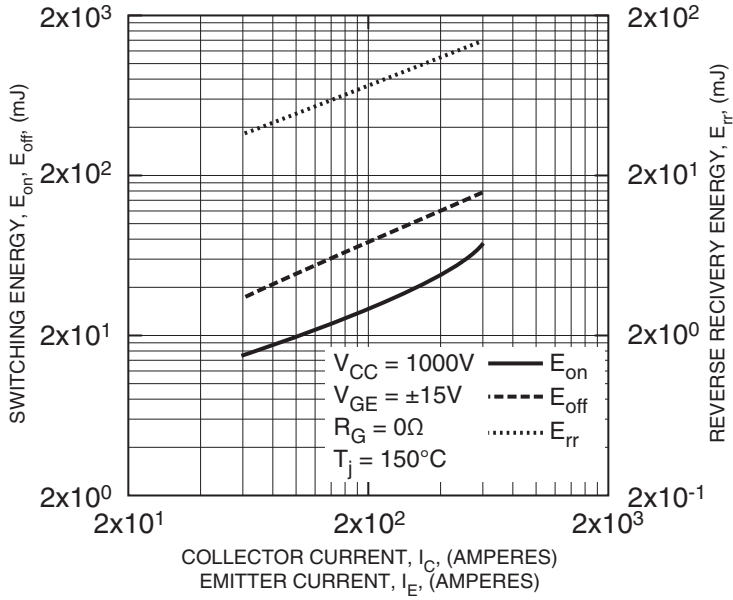

TRANSIENT THERMAL IMPEDANCE CHARACTERISTICS (TYPICAL)

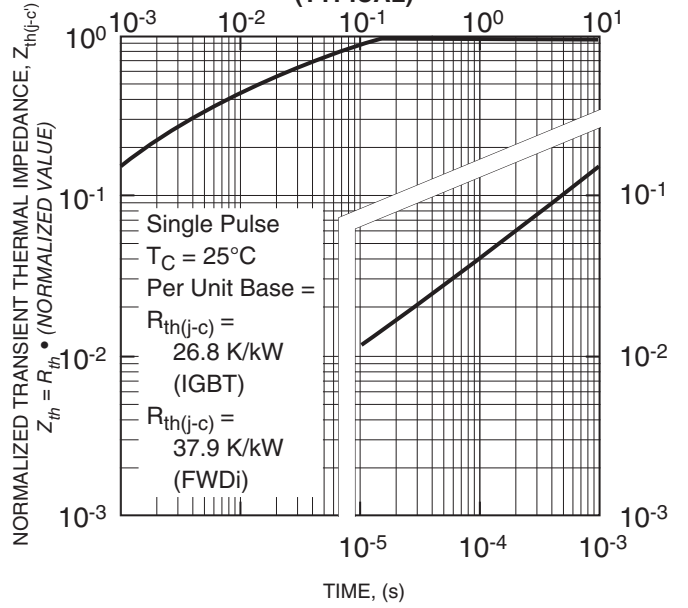

Information presented is based upon manufacturers testing and projected capabilities. This information is subject to change without notice. The manufacturer makes no claim as to the suitability of use, reliability, capability, or future availability of this product.