



**EN**

**IST-1100.CE01.02/B**

File: IST-1100 CE01 02-B\_CE100-EN.DOC

# **CENTRAL SYSTEM**

## **CE100**

### **USER INSTRUCTIONS**

**TECNOCONTROL S.r.l.**

Via Miglioli, 47 20090 SEGRATE (MI) - Tel. (+39) 02 26922890 - Fax (+39)02 2133734

http: [www.tecnocontrol.it](http://www.tecnocontrol.it)

e-mail: [info@tecnocontrol.it](mailto:info@tecnocontrol.it)

### **IMPORTANT NOTE**

***The control panel CE100 has three selectable languages:  
Italian, English and French.***

***If the control panel CE100 is not already set your language, please see on page 18 "Code Setup (Password)" and on page 20 "Setting the language".***

<b>Documento / Document name:</b> IST-1100 CE01 02-B_CE100-EN.DOC			
<b>Oggetto / Subject :</b> CE100			
<b>Rev.</b>	<b>Data / Date</b>	<b>Da / By</b>	<b>Note</b>
1	14/02/2008	UT/BD	Revised Text
A	27/07/2009	UT/FG	Revised Text and Diagrams
B	28/05/2012	UT/FG	Revised Text

## CONTENTS

<b>DESCRIPTION</b> .....	<b>4</b>
<b>CENTRAL SYSTEM MONITORING</b> .....	<b>5</b>
<i>Alarms Reset</i> .....	6
<i>Sensor Details Viewing</i> .....	6
<i>Enabling – Disabling Sensors</i> .....	7
<b>CE100 INSTALLATION</b> .....	<b>8</b>
<b>ELECTRICAL CONNECTIONS</b> .....	9
<b>CONNECTING THE DETECTORS</b> .....	10
<b>GAS DETECTORS USE</b> .....	11
<b>COLLEGAMENTO DELLA ELETTRICITÀ ALLA GAS</b> .....	12
<b>CENTRAL SYSTEM SETUP</b> .....	<b>13</b>
<i>Keyboard use and general information's</i> .....	13
<b>SENSORS SETUP</b> .....	13
<i>Table 2 - Pre-configured parameters for the Relays</i> .....	15
<b>SENSORS COPY</b> .....	16
<b>SENSORS DELETE</b> .....	16
<b>MODIFYING SENSORS SETUP</b> .....	16
<i>Sensor modification</i> .....	16
<b>CODE SETUP (PASSWORD)</b> .....	18
<b>LEVELS OF CODES AND DEFAULT CODES</b> .....	18
<b>CODE EDIT (PASSWORD)</b> .....	18
<i>Backlight</i> .....	19
<b>ELECTRICAL OPERATIONS "TEST"</b> .....	<b>19</b>
<i>Input Test (Detectors)</i> .....	19
<i>Output Test (Relays and Led)</i> .....	19
<b>SETTING THE LANGUAGE</b> .....	20
<b>APPENDIX</b> .....	<b>20</b>
<b>LIST OF ANOMALY MESSAGES AND ALARMS</b> .....	20
<b>LIST OF ACOUSTIC AND OPTICAL SIGNALS</b> .....	20
<b>TECHNICAL CHARACTERISTICS</b> .....	<b>21</b>
<i>Technical Characteristics central system Mod. CE100</i> .....	21
<i>Technical Characteristics Expansion CE101 (*)</i> .....	21
<i>Technical Characteristics Supply Module AL100</i> .....	21
<i>Technical Characteristics of Lead Battery charger AL101</i> .....	21
<i>Technical Characteristics of Lithium Battery charger AL102</i> .....	21
<i>Technical Characteristics of Lithium Battery BA100</i> .....	21
<b>CONFIGURABLE 4÷20 mA DETECTORS TABLES</b> .....	<b>22</b>
<i>Connecting Detectors 4-20mA two-wire products up to December2008</i> .....	22
<b>NOTES:</b> .....	23

## DESCRIPTION

The **CE100** gas Central System is realized for DIN rail mounting and it can be connected up to six 4÷20mA remote sensors. It represents a useful instrument for monitoring and controlling areas where there might be the presence of flammable, toxic gases or oxygen.

- **CE100 Central Unit:** data processing module, with keyboard, backlighted graphic display 122x32 pixel, no.2 4÷20mA sensors inputs and relays outputs.
- **CE101 Sensors Unit:** module with no.2 4÷20mA sensors inputs.(Max n. 2 modules for each CE100)
- **AL100 230V/24 Power supply:** module (230Vac-50Hz) with 24Vcc/15W output to powered the CE100 and no.2 CE101.
- **AL101 Pb Battery Power supply:** 12Vcc 3Ah or 7Ah Pb Battery power supply module.
- **AL102 Li-Ion Battery Power supply** module to be use with BA100.
- **BA100 Battery Li-Ion** module with lithium battery 10.8Vcc 1,7Ah to maintain the system powered on in absence of main power supply, to be use with AL102.

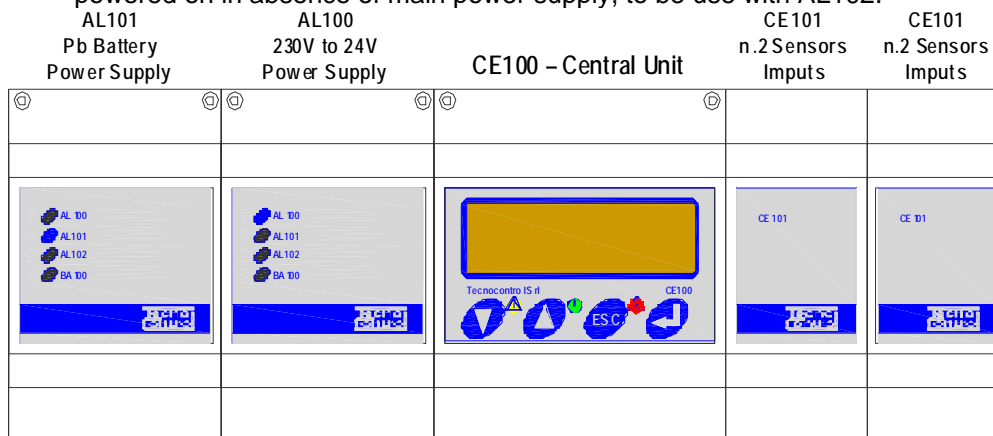

### Possible combinations:

<b>CE100</b>	The <b>Central Unit:</b> can autonomously works if it has an external power supply 12÷24Vdc (at least 15W). It has <b>no.2 4÷20mA sensor inputs</b> (S1-S2) and no. 4 outputs relays, of which no.3 alarm relays (U1-U2-U3) and no.1 Fault relay (U4).
<b>AL100 + CE100</b>	<b>Central unit powered at 230V:</b> to the central unit add the AL100 power supply, that connected to the 230Vca, powers the central at 24Vdc.
<b>AL100 + CE100 + n. 1 CE101</b>	<b>Combination for 4 sensors:</b> to the central unit (that has 2 inputs) add no.1 CE101 module to have other 2 inputs for 4÷20mA sensors (S3 e S4). AL100 power supply powers both the centrals CE100 and CE101.
<b>AL100 + CE100 + n. 2 CE101</b>	<b>Combination for 6 sensors:</b> to the central unit (that has 2 inputs) add no.2 CE101 modules to have other 4 inputs for 4-20mA sensors (S3, S4, S5 e S6). AL100 power supply powers both the centrals CE100 and CE101.
<b>AL100 + CE100 + one or two CE101 + AL101</b>	<b>Combination with Lead Battery:</b> to the previous combinations, it is possible to add the AL101 module to power a lead battery from 12Vdc 3Ah or 7Ah. (Not included in the supply).
<b>AL100 + CE100 + one or two CE101 + AL102 + BA100</b>	<b>Combination with Lithium battery:</b> in alternative to the previous one, it is possible to use the AL102 power supply and BA100 battery to Lithium-Ion 10.8/1.7Ah (the battery module has to be installed on the left part of the AL102 module).

- **CE100 central unit can be connected to:**

- **4÷20mA transmitters, 3 wires with "Replaceable cartridge sensor" for:**
  - Flammable gases with catalytic sensor:** type TS292K (IP65) or TS293K (explosion proof Ex-d) with range 0÷20%LEL
  - Flammable gases with Pellistor sensor:** type TS292P (IP65) or TS293P (Ex-d) with range 0÷100%LEL.
  - Toxic gases with electrochemical cell:** type TS220E (IP65) or TS293E (Ex-d)
  - Oxygen with electrochemical cell:** type TS220EO and TS293EO (Ex-d) with range 0÷25%O<sub>2</sub>.

- **NOTE:** Obviously also our previous transmitter's models made from December 2008 until today can be connected to this equipment, which are 4÷20mA transmitters, 3 wires for flammable gases type TS292K (IP65) or TS293K (Ex-d) with range 0÷20%LEL, or type TS293P (Ex-d) with range 0÷100%LEL and 4÷20mA transmitters 2 wires with electrochemical sensor for toxic gases and Oxygen, type TS220E (IP65). (See note and diagram at Page.22)
- **WARNING:** inputs can be taken on also with other sensors with range in % LEL or ppm that have a 4÷20mA signal referred to ground and working technical specifications (Range, minimum operating voltage, current absorbed, etc...) the same of our products.  
We disclaim no liability for malfunctions or failures caused by not compatible products.
- **The CE100 central unit has 3 Alarm relays:**
- Each sensor has 3 alarm levels associated to the Alarm Relays (PRE1, PRE2 and ALL). Consider that the three relays are in common with all sensors, but it can be set different alarm values for each single sensor.
- **The CE100 central unit has a Fault relay (FAULT)**
  - In case of Fault the sensors activate the common Fault Relay. (FAULT).
- **Every output relay can be configured as follow:**
  - **Delay ON** from 0 to 4 minutes at exceeding of the alarm threshold set.
  - **Delay OFF** from 0 to 30 minutes to the return under the threshold level set.
  - **Time ON** from 0 to 30 minutes, this function only works, if you want to stop the alarm output after a defined time, even if the sensor remains above the alarm threshold set. (The program does not allow setting it, if it's already used the "Delay OFF"). For example it can be used to activate devices that cannot be powered for a long time or to send an impulse to a telephone dialer or any other device.
  - **MEMORY** The relay stays in "Alarm" even if the sensor returns under its threshold level. (The program does not allow to set it, if it's already used the "Time ON"). Make the *RESET* to reset it to the normal conditions.
  - **LOGIC** the relay can be set in **POS**itive logic with normally closed contact (**NC**) or in **NEG**ative logic with normally opened contact (**NO**).
- **CE100 central unit has an internal BUZZER:**
  - It emits a "Beep", when the keys are pressed, moreover, from the Menu "Divers" (Miscellaneous), it can be chosen to let it active in case of Alarm (**ALL**)
- **CE100 central unit has got a function that allow to disabilities sensors:**
  - Each sensor can be "disabled" without remove or cancel it from the program.  
In this case, the sensor value will be visualized with \* symbol before the sensor number, but it cannot activate any relay. This function is useful in case of Faults, anomalies or maintenance and sensor calibration.
- **Ce100 central unit is protected from "PASSWORD"**
  - The menu access is protected through "**Code**" (4 numbers Passwords). To enter to this function it's necessary to digit the Password.

## CENTRAL SYSTEM MONITORING

When switching on the CE100, after the message shown by side, the display will show a 60 seconds count down. This is for stabilize the sensors and to avoid false alarms.

Then, the CE100 will show the situation of the connected detectors. The Display shows all detectors (max 6). (Detectors not programmed are indicated with a dashed line). Upper on the right is indicated the enabled code level. (See at page18 chapter *Password*).

For each sensor, the display shows the measured value and also its status: **FAULT**< (<1mA) **PRE1, PRE2, ALL, FAULT**> (over 24 mA). (See explanation in the chapter "*Sensor details*").

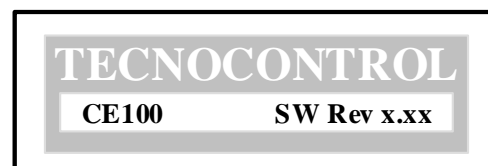



-1-	
1: 0000 LEL	4: 0004 ppm
2: 0006 ppm	5: 0001 LEL
3: 0000 LEL	6: - - - - -

**Important Note:** all detectors inputs are protected against wire breakings (connection between detectors and Central System) and against short circuits. If a short circuit occurs, to avoid damages to the central system or to the sensor, the power supply to that input, is automatically stopped (all others continue to work properly). Simultaneously the yellow LED "FAULT" lights up and the correspondent relay is activated (if programmed). Only after having solved the short circuit problem (to test if the channel is no more in short circuit protection you need to measure if there is voltage between the terminals "+" and "-" with a multimeter) it will be possible to restore normal operational conditions.

### Alarms Reset

This procedure should be performed to reset the relay outputs, programmed latched in normal conditions, only when the alarm situation is finished.

From the normal screen, press key **ESC** to access to **MAIN MENU**. Select "1-Reset" then press  to confirm.

(The menu selected is indicated by an arrow and by the dark background. Keys   are used for navigate into the menus, those indicated semi-hidden can only be activated with the code).

After the message **RESET DONE**, display return to the **MAIN MENU**. Press **ESC** to view the normal screen.



#### MENU PRINCIPALE

- ▼ 1 **Reset**
- 2 **Details**
- 9 Enabling
- 4 Disabling
- 5 Divers (Miscellaneous)
- 6 Configuration
- 7 **Code (Password)**
- 8 **Menu Protected**
- 9 Service

Reset  
Done

### Sensor Details Viewing

This function allows you to view all parameters of each sensor.

From the **MAIN MENU** press  to select 2-Details then press  to confirm. All settings details about **Sensor no. 1** will appear.

Using keys  and  all Details can be seen:

1<sup>st</sup> line: type of sensor, 2<sup>nd</sup> line: the name of sensor, 3<sup>rd</sup> line: scale settled, 4<sup>th</sup> line: the sensor status, 5<sup>th</sup> line: input current in mA. Then, you can see the values of the alarm levels (PRE1, PRE2, ALL).

Pressing key  you can see details of the other

sensors. (If a sensor is not used, it will appear a dashed line) Press **ESC** to go back to the **MAIN MENU**.

**NOTE:** In the 4th line, after the value, shows the status of the sensor, with this significance:

**FAULT** < (<1 mA) ..... Sensor fault, disconnected or not powered

**NORMAL** (up to PRE1) ..... Sensor is in its normal operating conditions.

**PRE1, PRE2, ALL** ..... the sensor has exceeded the set alarm levels, is always shown the highest alarm.

**FAULT** > (above 24 mA) ..... The sensor is measuring a gas concentration beyond all limits, or is broken or disconnected.

#### MAIN MENU

- 1 **Reset**
- ▼ 2 **Details**
- 3 Enabling

#### Details

▼ **Sensor n. 1**  
**TS292KM**  
**0020 LEL**  
**0000 LEL: Normal**  
**I = 04.0 mA**  
**0010 LEL : PRE 1**  
**0015 LEL : PRE 2**  
**0020 LEL : ALL**



**WARNING:** From the main menu to access the menu 3-Enable, Disable 4-and 5-Miscellaneous, you must enter the CODE LEVEL 2 (See chapter "Code" on p. 18).

### Enabling – Disabling Sensors

Each single sensor can be "Disabled" and then "Enabled" without having to delete it from the program. The CE100 will continue to display it, with the symbol \* next the sensor number, but it will not activate any alarm. This function is useful in case of faults, malfunctions or maintenance and calibration of the sensors.

From the normal screen, press  to access to **MAIN**

**MENU.** After having inserted the code level 2, with 

 select "3-Enbling" or "4-Disablling" then press  to confirm. Then with the same key select the number of sensor to be *Enabling* or *Disabling*.

Pressing the key  the following message will appear *Sensor enabled* or *Sensor disabled*.

Press  to return to **MAIN MENU**.

#### MENU PRINCIPALE

▼ 2 Details  
3 Enabling  
▲ 4 Disabling





Disabling  
Sensor n° 1  
TS292KM

Disabling  
Sensor n° 1  
TS292KM  
SENSOR DISABLED

### SETTING FUNCTION "MISCELLANEOUS"

This function allows you to set some options.

From the **MAIN MENU** press  select "5-Miscellaneous"

press  to confirm and then with  o  select the desiderate choice (highlighted line). Press  to go to the next line and in the same way you can set the required value. Press  to return to **MAIN MENU**.

**BUZZER:** If you select YES means that in case of alarm, as well as the red Led also the internal buzzer will activated. If you select NO, the buzzer will never switched on.

**BATTERY:** Select ABSENT if you have not installed any supply module for the backup battery.

Select AL101 if the CE100 is installed with the Module AL101 to charge a lead acid battery (12V 7Ah max).

Select AL102, if is installed the AL102 battery charger module and BA100 Lithium Battery Module (10.8V 1.7Ah).

**NOTE:** If in the row **BATTERY**, it was selected the AL101 or AL102, the CE100 activates automatically, a test of one minute every 24 hours. If the battery is low voltage or exhaust, the yellow LED will flash to indicate the fault.

**EV STATUS (electro valve)** select **YES** if you installed a solenoid Tecnocontrol (models from VR480 to VR400) with the position sensor connected to the "CONTACT SOLENOID VALVE".

Press  to return to **MAIN MENU**.

In case of alarm the CE100 will check if the valve has effectively closed, otherwise the yellow LED will light on and the fault relay will activate (**FAULT**). The display will show the symbol  for the failure to close.

**NOTE:** This control acts only on the 3th alarm level, and then the valve must be connected to relay ALL.

#### MAIN MENU

▼ 3 Enabling  
4 Disabling  
▲ 5 Miscellaneous

Miscellaneous  
BUZZER : OFF  
BATTERY : ABSENT  
EV STATUS : NO

Miscellaneous  
BUZZER : OFF  
BATTERY : AL101  
EV STATUS : NO

Miscellaneous  
BUZZER : OFF  
BATTERY : AL 102  
EV STATUS : NO

Miscellaneous  
BUZZER : OFF  
BATTERY : AL 101  
EV STATUS : YES



**IMPORTANT REMARK** INSTRUCTIONS INCLUDED INTO THE MANUAL BELOW INCLUDE INSTALLATION AND SYSTEM SETUP PROCEDURES TO BE EXECUTED ONLY BY QUALIFIED AND AUTHORIZED PEOPLE.

## CE100 INSTALLATION

The control panel should be mounted in a suitable enclosure or cabinet to accommodate modules on a DIN rail. For your convenience, we recommend to install the modules in the order shown, with the power supplies on the left of CE100 and the expansions on the right. The space occupied, depends on the configuration of CE100 (see fig. 1).

The full configuration with lithium-ion battery is 17 modules. For example, can be used an 18 modules enclosure, available from most suppliers of electrical equipment (e.g. in Fig. 2).

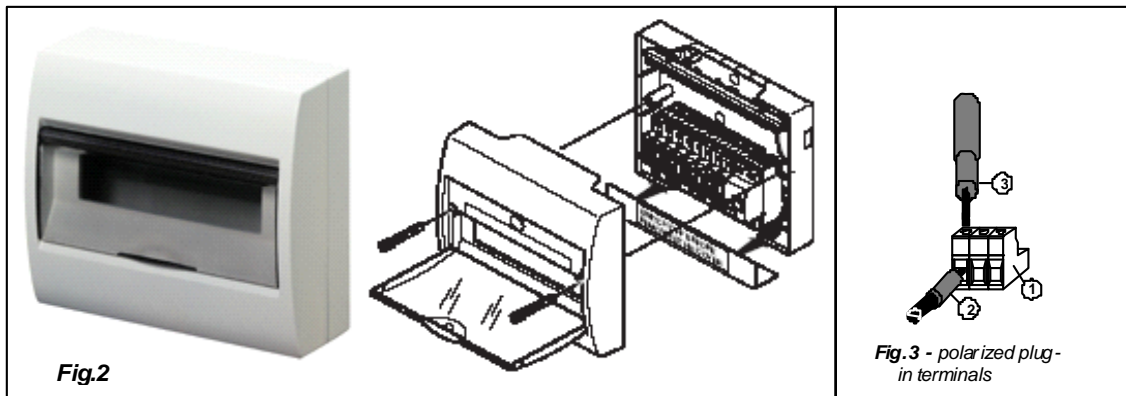
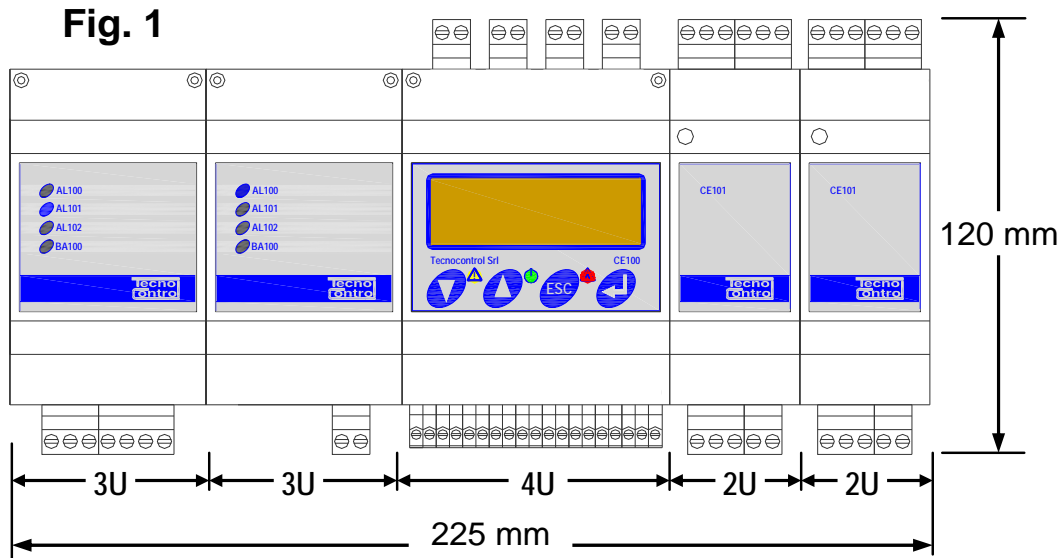

### **WARNINGS:**

- A. Do not install the modules CE100 near heat sources such as contactors, power supplies or other.**
- B. Terminals (Fig. 3) are polarized plug-in (1); we recommend using appropriate cable lugs to the conductors (2) and anchor the cables to the structure to avoid excessive stress to the circuit and the terminals themselves. Use a screwdriver (3) with a suitable size.**
- C. The wiring diagrams on the following pages, for simplicity are always shown with all the sensors.**



**ELECTRICAL CONNECTIONS**

**MODULE AL100** (AC 230Vca/24Vdc-15W)

**230Vac Power supply** mains must be connected to terminals "L e N". (See figure 4).

**MODULE AL101** (AC 230Vca charger for Lead 12V Battery)

**230Vac Power supply** mains must be connected to terminals "L e N". (See figure 4).

**Battery** can be used a 12V Lead battery with a capacity for the request autonomy and the connected total load. *With one 3Ah, battery life is about 2 hours (with n. 2 Sensors and Gas Valve 12V-12W max); while with a 7Ah you have more than 3 hours life (with n. 4 or n. 6 Sensors and a Gas Valve 12V-12W max). The battery must be connected to AL101 terminals "B +" (red) and "B-" (Black) (see figure 4).*

**Example** for calculating the hours of autonomy of an installation with 4 sensors (typically absorb 2W each) and a 12V solenoid valve that absorbs 12W:

$$\frac{12 \times \text{no. Ah of the Battery}}{\text{no. of connected gas detectors} \times 2W + \text{no. W of the electrovalve}} = \frac{12 \times 7Ah}{(4 \times 2W) + 12W} = 4 \text{ hours}$$

**Connecting to the CE100** the power supply should be connected to the CE100 with 3-wire on terminals "INT, + and -" as shown in figure 4.

**Fig 4– Connection Diagram with Power Supply Module AL101**

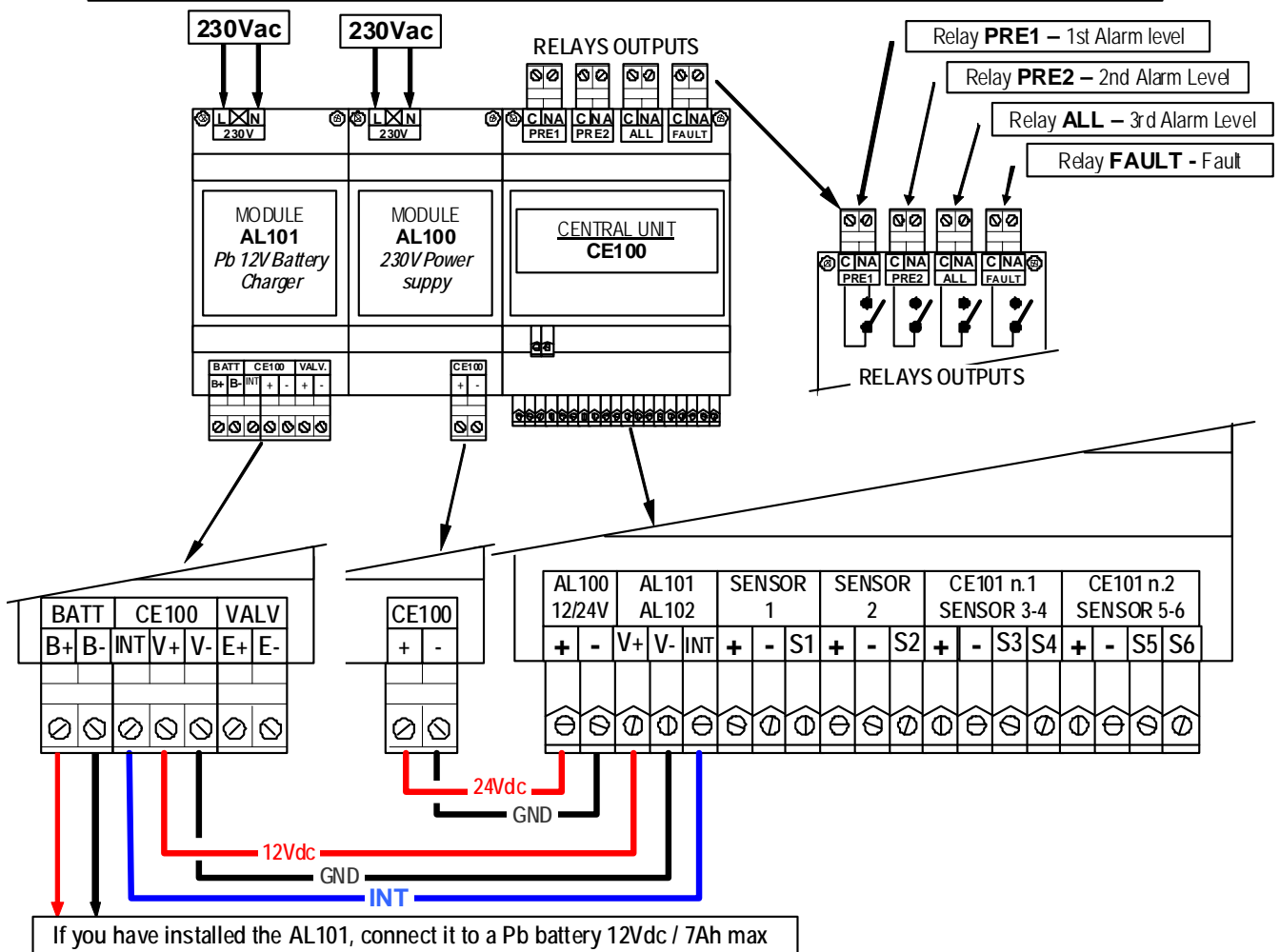

**CENTRAL UNIT CE100**

**Inputs:** Please see the chapter on the next page "Connecting the detectors".

**Outputs:** all 4 relays have only one voltage-free changeover contact. The contact rate (resistive) is 3A at 250Vac. All output relays contacts are indicated with "C" (common), "NO" (normally open). This designation refers to the relay in position without power, or programmed in negative logic. During the programming can be chosen if every single alarm relay must be in "Negative logic" (the contact will be NO) or "Positive logic" (the contact will be NC). (See fig. 5, fig. 7 and the NOTE on page 12).

**MODULE AL102** (AC 230Vac charger for Li-Ion BA100 Battery)

**230Vac Power supply** mains must be connected to terminals "L e N". (See figure 5).

**Battery** the BA100 module, which contains the lithium battery, has a cable that should be connected to the corresponding socket.

**Connecting to the CE100** the power supply should be connected to the CE100 with 3-wire on terminals "INT, + and -" as shown in Figure 5.

**Fig 5– Connection diagram as in Fig.4, but with Modules AL102 and BA100**

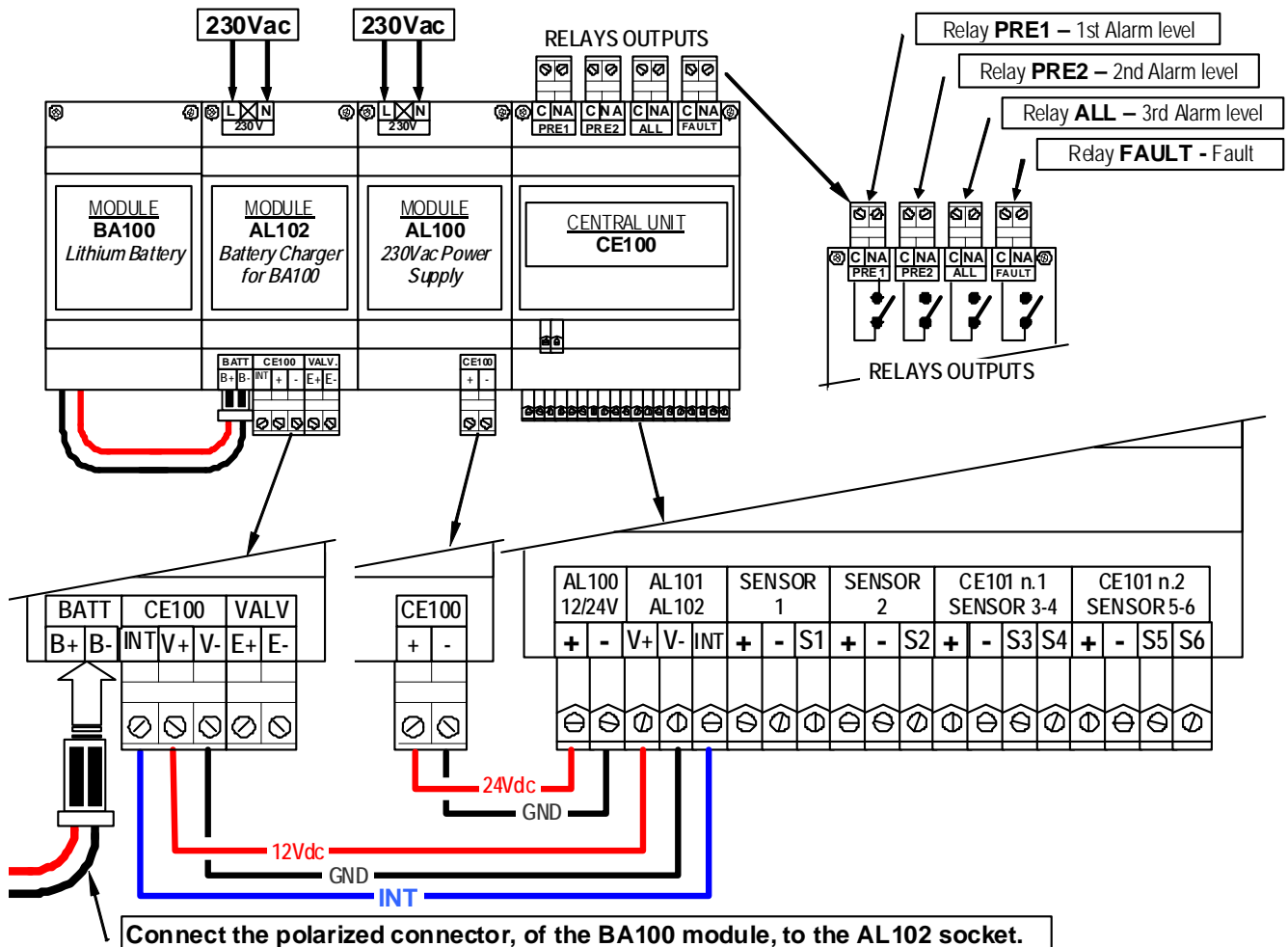

## CONNECTING THE DETECTORS

**CENTRAL UNIT CE100** can be connected up two detectors with 4 to 20mA output (S1 and S2). To have other four (from S3 to S6), you need to install the Expansion Modules CE101.

**CE101 MODULE** (Expansion of two inputs for detectors 4 to 20mA)

**Inputs** by installing a CE101 module can be connected two sensors (S3 and S4). Installing a second CE101 module can be connected other two sensors (S5 and S6).

**Connecting with CE100** the first module CE101 should be connected with 4 wires, to CE100 terminals "+, -, S3 e S4", as shown in figure 6. If you installed the second module CE101, it should be connected to the CE100 terminals "+, -, S5 and S6".

### Connection with 3-wires 4÷20mA gas detectors

- **Detectors for flammable gases with "Replaceable Cartridge Sensor":** *with Catalytic sensor:* TS292K (IP65) or TS293K (Explosion-proof Ex-d) series with 0÷20%LEL range and *with Pellistor sensor:* TS292P (IP65) or TS293P (Ex-d) series with 0÷100%LEL range.
- **Detectors with "Replaceable Cartridge Sensor" using electrochemical cells:** for toxic gases TS220E (IP65) or TS293E (Ex-d) series and for oxygen TS220EO e TS293EO (Ex-d) series with 0÷25%O<sub>2</sub> range.

The connection with 4 to 20mA three wires detectors should be performed (fig. 6) between detector's terminals "+", "-" and "S" and the corresponding input terminals of the CE100 and CE101 modules.

The section of the connecting cables between the panel and the sensors must be adequate to the distance and the type of sensor used, as shown in Table.

Distance	Cable
from 0 up to 300 meters	3x1.5 mm <sup>2</sup> shielded
From 300 up to 600 meters	3X2.5 mm <sup>2</sup> shielded

We recommend the use of shielded cables, the screen (shield) must be connected only by the central side and a single point of "GROUND".

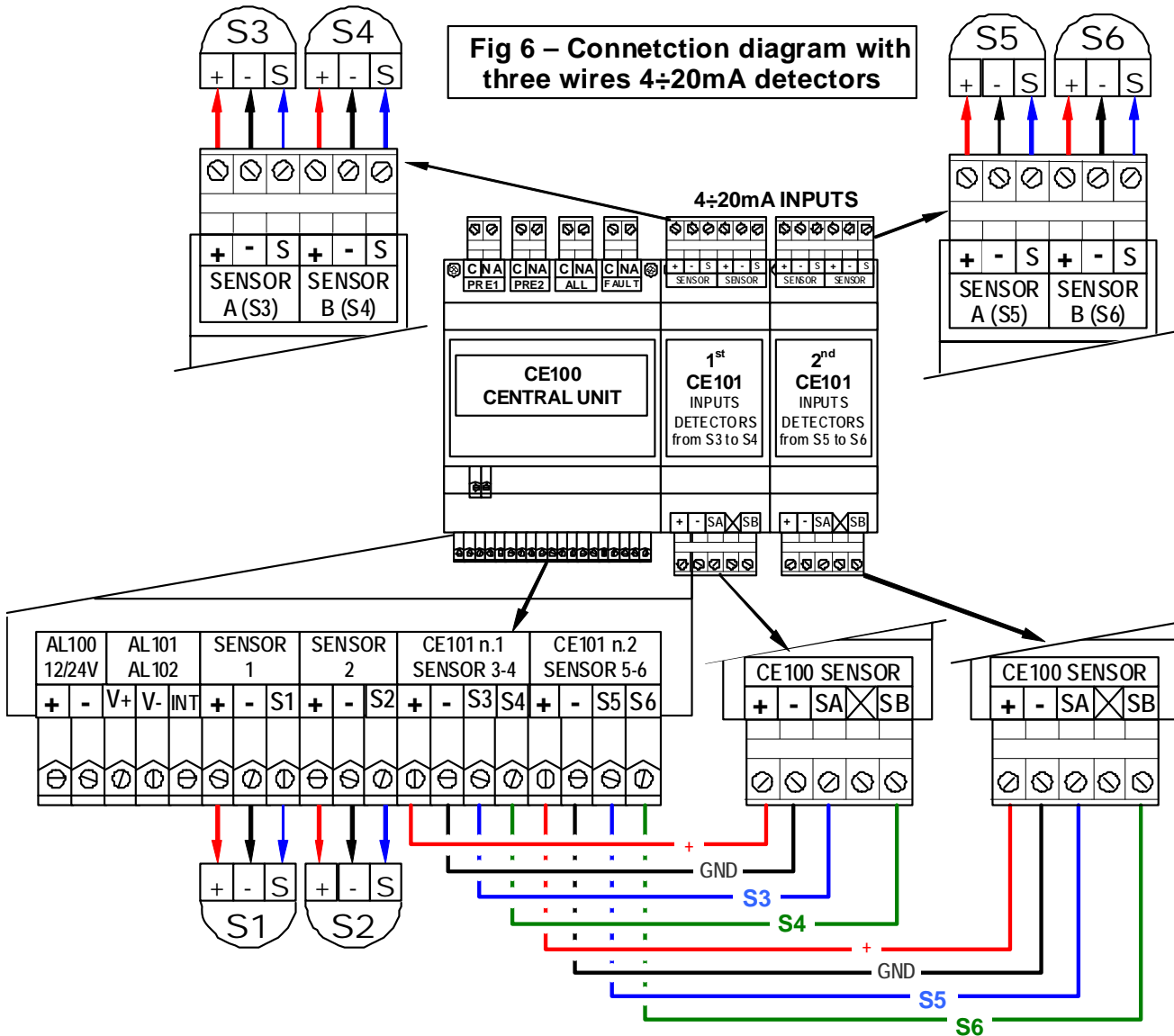

**GAS DETECTORS USE**

**WARNING** Always refer to specific instructions attached to them. Please note that all documentation attached to the products "Central Unit and Gas Detectors" must be read and kept.

**COLLEGAMENTO DELLA ELETTROVALVOLA GAS**

The Manual Resetting NO or NC Solenoid Gas Valve or if required, the Automatic too with 230Vac supply, must be connected as shown in fig.7. If the valve has a 12V coil, please use the note at the bottom of this page and the figure 8, without consider the "Solenoid Valve with Position Sensor" not present in the "Normal" Solenoid valve.

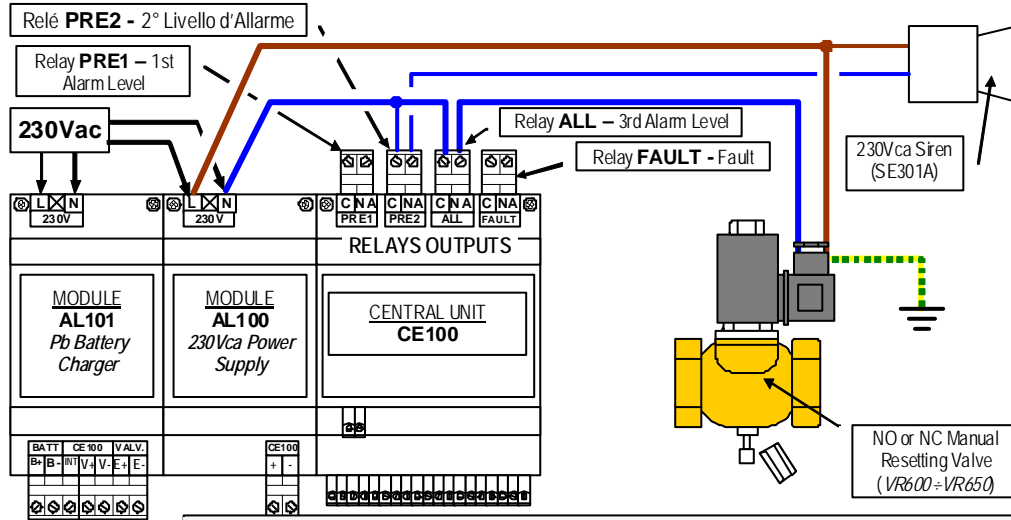

**Fig 7– Wiring diagram with gas valve and Siren**

**CONNECTION OF THE SOLENOID GAS VALVE WITH POSITION SENSOR**

If you have installed a Tecnocontrol solenoid valve with the position sensor (VR400 to VR480 models) connected to the "VALVE CONTACT", in the menu "MISCELLANEOUS" you must configure YES the **STATE EV (Electro Valve)**.

**WARNING:** This control works only on 3rd alarm level, so the valve must be connected to relay ALL.

If an alarm occurs, the CE100 will check if the valve has been effectively closed, otherwise the yellow LED will light and the FAULT relays activates. The display will show the symbol  for the failure to close.

**Fig 8– Wiring diagram with gas valve with position sensor and Siren**

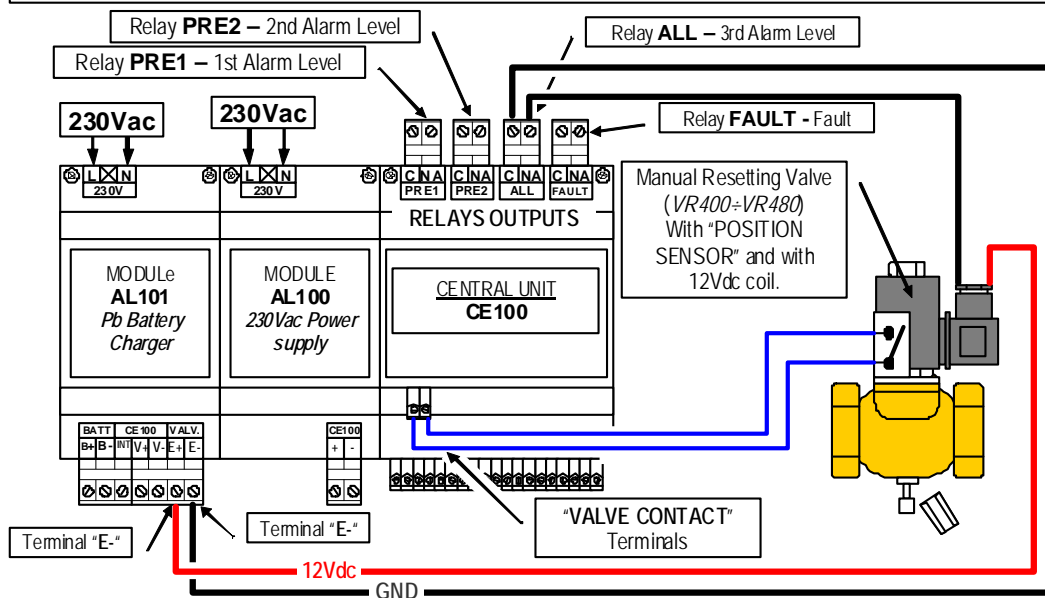

**NOTES:** The AL101 and AL102 modules have an auxiliary output "VALVE" at 12VDC/12W max (terminals E+ and E-). You can power a gas solenoid valve or other device, operating at 12VDC (10.8÷13.8VDC), whose absorption maximum does not exceed 12W (1A). This output is protected from "Short Circuit", but should not be connected loads that exceed the indicated current capacity, or which may generate noise on power supply.

## CENTRAL SYSTEM SETUP

### Keyboard use and general information's

The numbers to be changed or entered appear on the display highlighted by the *Cursor* (flashing black rectangle). To change or enter a number you can use:

The key  to move up or increase a value.

Key  to move down or decreases a value.

Key  to confirm or to enter in the Reset Menu.

Key  to enter and exit menus.

After having entered the first sensor setup, the software propose this setup as the standard for all others sensors, in this case, if you are entering more sensors with the same setup, all operations will be much more easy and quick.

### SENSORS SETUP

If any sensors have been already configured, the following message will be displayed:





-3-	
1:-----	4:-----
2:-----	5:-----
3:-----	6:-----

#### IMPORTANT NOTES

**A - To set up the Central or make changes later, from the normal screen, press  to enter the MAIN MENU. Select 8-Protected Menu and then enter the "Code Level 3".** (Please see on [page 18](#) chapter CODES).



**B - At the first set up, the sensor no. 1 must be programmed first. Why choosing the type of "valve", if installed, is binding, you cannot change this set up in the other sensors, because the choice only affects the 3rd Alarm Relay "ALL", it follows that the gas shutoff valve should only be connected to these relays.**



Pressing the  key, you enter in the **MAIN MENU**.

After entering the code (*CODE ACCEPTED*), press  to return to **MAIN MENU**, then press key  select "**Set up**" and press  to confirm. Now, press  to select the sensor number to be configured and press  to confirm.

#### Example:

"1-Sensor Choice" Select "1" press  to confirm and advance to the next line.



"Model", with key  selects the installed gas detector type (e.g. **TS293Px**) then press . (See the following [pages to Tables 1 and 2](#)).

"Valve" presses key  to select the desired valve type, if installed. After selecting one of the three options below, then press  to confirm.

*NO* = Normally Open

*NC* = Normally Closed

*NOT* = No Valve installed

"CONFIRM" will be asked to confirm the inserted set up, with the arrow  select *YES* and then  to confirm. If you leave *NO* the operation will be cancel (please see chapter "**DELETION SENSORS**").

#### MAIN MANU

 4 Exclusion  
5 Miscellaneous  
6 Configuration

Sensor choice  
Sensor n. 1

Sensor Choice  
Sensor n. 1  
Model : TS293Px

Sensor Choice  
Sensor n. 1  
Model : TS293Px  
Valve : NO  
CONFIRM ? NO

**Table 1 - Pre-configured parameters of the detectors (sensors)**

To simplify setup, the models indicated in the table are pre-configured with default settings; you can use in common situations. The detectors into brackets has operational characteristics identical to the first highlighted in bold, the only difference is the type of protection custody. If necessary you can also configure other detectors, selecting the "Generic" ones. In addition, you can change all parameters of each sensor according individual requirements.

<b>MODEL</b>	<b>GAS</b>	<b>RANGE</b>	<b>UNITS</b>	<b>PRE1 (Level 1)</b>	<b>PRE2 (Level 2)</b>	<b>ALL (Level 3)</b>
<b>TS220EA</b> (TS293EA)	NH <sub>3</sub>	0-300	ppm	10	20	50
<b>TS220EC</b> (TS293EC) <sup>(2)</sup> TS250CB)	CO	0-300	ppm	50	100	200
<b>TS220EH</b> (TS293EH)	H <sub>2</sub> S	0-100	ppm	10	20	50
<b>TS220EN</b> (TS293EN)	NO	0-100	ppm	10	20	50
<b>TS220ES</b> (TS293ES)	SO <sub>2</sub>	0-20	ppm	10	20	50
<b>TS292KG</b>	LPG	0-20	%LEL	10	15	20
<b>TS292KM</b>	METHANE	0-20	%LEL	10	15	20
<b>TS292Kx</b> (TS292KB, TS292KI) <sup>(2)</sup> TS250CB)	INFLAMMABLE	0-20	%LEL	10	15	20
<b>TS293KG</b>	LPG	0-20	%LEL	10	15	20
<b>TS293KM</b>	METHANE	0-20	%LEL	10	15	20
<b>TS293Kx</b> (TS293KB, TS293KI)	INFLAMMABLE	0-20	%LEL	10	15	20
<b>TS292Px</b> (TS292PM, TS292PG, TS292PI, TS292PB)	INFLAMMABLE	0-100	%LEL	10	15	20
<b>TS293Px</b> (TS293PX-S, TS293PX-H, TS293PE, TS293PS)	INFLAMMABLE	0-100	%LEL	10	15	20
<b>IR101</b>	CO <sub>2</sub>	0-2.00	% vol.	0.20	0.50	1
<b>IR102</b>	CO <sub>2</sub>	0-2.00	% vol.	0.20	0.50	1
<b>Generic</b>						
<sup>(1)</sup> <b>TS220EO</b> (TS293EO)	Oxygen (O <sub>2</sub> )	0-25.0	% vol.	18.5	19.5	22.5

**NOTE - (1):** The alarms can be set for the oxygen detectors are: PRE1 and PRE2 to lack, and ALL for excess oxygen. Furthermore, the alarm threshold PRE2 activates the 1st relay (PRE1), while the threshold PRE1 activates the 2nd relay (PRE2).

**NOTE - (2):** The twin TS250CB detectors must be programmed on two distinct inputs. The CO as TS220EC and gasoline vapours as TS292Kx.





Table 2 - Pre-configured parameters for the Relays

MODEL	Relay PRE 1	Delay ON (sec)	Delay OFF (sec)	Positive Logic	MEMORISED	Relay PRE 2	Delay ON (sec)	Delay OFF	Positive Logic	MEMORISED	Relay ALL.	Delay ON (sec)	Delay OFF (sec)	Delay OFF (sec)	Positive Logic	MEMORISED	Relay FAULT	Delay ON (sec)	MEMORISED
TS220EA	K1	1	1	NO	NO	K2	1	1	NO	NO	K3	30	1	1	SI	YES	K4	30	YES
TS220EC		1	1	NO	NO		1	1	NO	NO		30	1	1	SI	YES		30	YES
TS220EH		1	1	NO	NO		1	1	NO	NO		30	1	1	SI	YES		30	YES
TS220EN		1	1	NO	NO		1	1	NO	NO		30	1	1	SI	YES		30	YES
TS220EO		1	1	NO	NO		1	1	NO	NO		30	1	1	SI	YES		30	YES
TS220ES		1	1	NO	NO		1	1	NO	NO		30	1	1	SI	YES		30	YES
TS292KG		1	1	NO	NO		1	1	NO	NO		30	1	1	NOTA 1	YES		30	YES
TS292KM		1	1	NO	NO		1	1	NO	NO		30	1	1	NOTA 1	YES		30	YES
TS292Kx		1	1	NO	NO		1	1	NO	NO		30	1	1	NOTA 1	YES		30	YES
TS293KG		1	1	NO	NO		1	1	NO	NO		30	1	1	NOTA 1	YES		30	YES
TS293KM		1	1	NO	NO		1	1	NO	NO		30	1	1	NOTA 1	YES		30	YES
TS293Kx		1	1	NO	NO		1	1	NO	NO		30	1	1	NOTA 1	YES		30	YES
TS292Px		1	1	NO	NO		1	1	NO	NO		30	1	1	NOTA 1	YES		30	YES
TS293Px		1	1	NO	NO		1	1	NO	NO		30	1	1	NOTA 1	YES		30	YES
IR101		1	1	NO	NO		1	1	NO	NO		30	1	1	NOTA 1	YES		30	YES
IR102		1	1	NO	NO		1	1	NO	NO		30	1	1	NOTA 1	YES		30	YES
Generic	1	1	NO	NO	1	1	NO	NO	30	1	1	NOTA 1	YES	30	YES				



**NOTE 1** "YES" if we choose NC VALVE (normally closed valve) or "NO" for NO Valve (normally open valve) or NOT VALVE. TIME ON (in seconds) for all relays K1, K2, K3 and K4 is= 0. This parameter should only be used and as indicated in "Change Sensor" on page 17.





## SENSORS COPY

From the **MAIN MENU**, with key  select the sub-menu "Setup". Press , select with  "2-Sensor copy" then press  to confirm.

Sensor choice Select with  the desired sensor you wish to copy and then press  to confirm.

Sensor copy to an arrow with a number reference on its right will appear. With  insert the desired sensors to be copy and then press .to confirm.

"CONFIRM" will be asked to confirm the configuration inserted. With  select YES and press .

If you leave NO the operation will be cancel

### Setup

- 1 Sensor choice
- 2 Sensor Copy
- 3 Sensor delete

### Sensor copy

Sensor n. 1  
TS292KM





### Sensor copy



Sensor n. 1 → 2  
TS292KM



### Sensor copy

Sensor n. 1 → 2  
TS292KM  
CONFIRM ? NO

## SENSORS DELETE

From the **MAIN MENU**, with key  select the sub-menu "Setup". Press , select with  "3-Sensor delete" then press  to confirm.

Sensor Selection: with , choose the number of sensor to be deleted, and then press  to confirm.

Confirm: will be asked to confirm the cancellation with , select YES and press  to confirm. If you leave NO, the operation will be cancelled.





**NOTE: You cannot delete the sensor No.1.**



## MODIFYING SENSORS SETUP

It is possible to modify a sensor already configured in two ways:

- 1 - If you want to change the threshold values or alarm output is sufficient to operate as described below in section **Sensor Setup**.
- 2 - If you need to change sensor model, (except No. 1 which can be reconfigured only) is recommended before, delete it, then configure it as if new, see the previous paragraph **Sensors delete**.

### Sensor modification

From the **MAIN MENU**, with key  select the sub-menu "Setup". Press , select with  "4-Sensor modification" then press  to confirm.

Sensor Selection: with , choose the number of sensor to be deleted, (The sensors are not configured, are indicated with a dot line) then press  to confirm.

**NOTE**: If you do not want to continue, press twice  to return to the **MAIN MENU**.



### Setup



- 2 Sensor copy
- 3 Sensore delete
- 4 Sensor modification

### Sensor modification

Sensor n. 3  
Model : TS292KM

"PARAMETERS" parameters are proposed in succession, to move to the next without changing it, simply press .

"Endo of scale" (Full Scale 9999 max) you can change this value with the keys   then press  to confirm.

"Unit" (LEL, %, ppm, °C) to change this value, using the keys   then press  to confirm.

"Level PRE1" modify with   then press .

"Level PRE2" modify with   then press .

"Level ALL" modify with   then press .

Sensore modification  
Parameters  
End of scale : 0020

Sensore modification  
Parameters  
Level PRE 1 : 0010

Sensore modification  
Output PRE1  
Delay ON : 00'01"

Sensore modification  
Output PRE1  
Delay OFF : 00'01"

**NOTE:** The three thresholds value must have an increasing progressive value or equal, with the exception of the Model TS220EO or TS293EO Oxygen (See NOTE 1 at the bottom of Table 1).



"Output PRE1" first alarm threshold.

"Delay ON": is the delay of the relay output, in minutes and seconds (max 4'10"), since the alarm threshold is exceeded.



"Delay OFF": is the time, in minutes and seconds (max 30'), during which the output (relay) remains active, even after the end of the alarm condition.

"Time ON": is the interval of time, in minutes and seconds (max 30'), during which the output remains activated, from when it is exceeded the alarm threshold. At the end of this time, the output (relay) returns to normal operation even if the value and above the alarm threshold

**WARNING:** "Time ON" can be set, only if the "Delay OFF" is set to "ZERO" and is not selected "Latched output" YES.

"Positive logic" Indicates if the relay works with Normally Closed contact (Positive), normally open or normally (Negative). Modify this with key , to "NO" (Negative) or "YES" (Positive), then press  to confirm.

Sensor modification  
Output PRE1  
Positive Logic : NO

"Latched output" if you want the output remains activated, even when the alarm returns under its threshold. Modify this with key , to "NO" or "YES" and then press  to confirm.

Sensor modification  
Output PRE1  
Latched Output: NO

**WARNING:** "Latched output" YES, can only be set if the Delay OFF and Delay ON time, are set to "ZERO". Normally the "Latched output" YES" is used on the 3rd alarm level, to prevent resetting of the solenoid gas valve (either manual or automatic resetting) without first verifying that the Central Unit is in alarm.

Then, continue as above, also for the other items "Output PRE2" (2nd alarm threshold - Relay PRE2), "Output ALL" (3rd alarm threshold - Relay ALL) and "Output FAULT" (indicating a failure - FAULT relay).

**CONFIRM:** will be asked to confirm the changes inserted (if you leave NO, the whole operation will be cancelled).

By key  selecting YES and then press  to confirm, and then press  to return to the MAIN



**MENU.**





Sensor modification  
Sensor n° 1  
Model : TS292KM  
CONFIRM ? NO

## CODE SETUP (PASSWORD)

The code consists of an access key that, when inserted, is to protect all the system settings from unauthorized changes. If you want to change the Setup of inputs, outputs and the Code, you must first enter the correct code.

From the **MAIN MENU**, with key  select the sub-menu "*8-Protected menu*". Press  to confirm.

When the message "*CODE LEVEL 1*" (which in this version is not active) with the keys   you can move to the "*CODE LEVEL 2*" or "*CODE LEVEL 3*", then made the choice you want, press  to confirm.

To select the code, with the keys   moves the cursor to the request number, and with  confirms the choice. After entering the 4 digit, display will show "*CODE ACCEPTED*", press , to return to the **MAIN MENU** and now you can change the settings enabled.

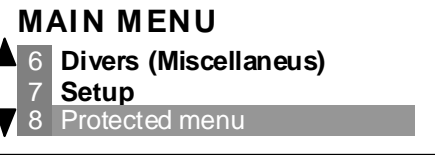

Protected Menu  
CODE LEVEL 2

Protected Menu  
INSERT CODE 2

0123456789#%&-

## LEVELS OF CODES AND DEFAULT CODES



The CE100 has three levels of code, with different access so as to allow people with different responsibilities and expertise to operate on the central unit. The three "Code Levels" are factory preset, it is recommended to change them anyway, and keep them carefully.



**Code 1** in this version, has no effect on the menu, under normal use you can go directly to the menu *1-RESET*, *2-DETAILS*, *7-CODES*, and *8-PROTECTED MENU*.

**Code 2** 2222 for use by the plant manager, also gives access to the menu *3-ENABLE*, *4-DISABLE*, and *5-MISCELLANEOUS*



**Code 3** for maintenance or installation, gives access to all menus.



## CODE EDIT (PASSWORD)

From the **MAIN MENU**, with key  select the sub-menu "*7-Code*" and press  to confirm.

Appear, "*CODE LEVEL 1*" (which in this version is not active) then the keys   you can move to the "*CODE LEVEL 2*" or "*CODE LEVEL 3*".

After you make your selection, press  to confirm.

After selecting the code level to edit, **enter the 4 digit original code**, with keys   scroll numbers and confirm with . (For each number entered will appear a star for confirmation).

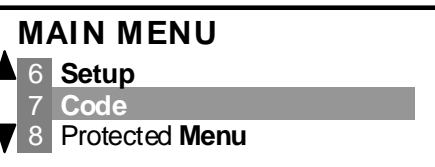

Then **enter the New Code**, scroll the numbers with keys   and confirm with .



Code  
CODE LEVEL 2

Code  
INSERT CODE 2  
★★★★  
0123456789#%&-

Code  
NEW CODE 2  
★★★★  
0123456789#%&-

Then to confirm **reenter the New Code**, scroll the numbers with keys   and confirm with .

Now will show *STORED CODE*, with  you will return to the **MAIN MENU**.

From this moment, the new inserted code becomes active.

Code  
CONFIRM CODE 2  
★★★★  
0123456789#%&-

Code  
CODE STORED

***PAY ATTENTION: we suggest writing and keeping the Password in a safety place. In case you lose the Password get in contact with our technical support.***



## Backlight

The display backlight will automatically switch off, when not used, after 60 seconds; pressing any key it light back again.

## ELECTRICAL OPERATIONS "TEST"

***WARNING: This procedure must be performed with extreme care by trained and authorized personnel, because both are activated relay outputs that activate the connected devices, both internal functions the control panel.***

The CE100 is equipped with a test program that allows verifying the electrical operation



From the **MAIN MENU**, after inserting the **Code Level 3**, with  select the submenu "9-Service" and then press  to confirm.

### Input Test (Detectors)

With key  select "1-Test Inputs" and then press .

Now, you will see the sensor's values, expressed in mA, even those not configured. Obviously does not consider the value of those not installed, which can be "0mA" to "50 mA". At the centre of the display there will be the symbol of the solenoid valve with Position Sensor.

### Output Test (Relays and Led)

Press key  to go back to menu "Service", with key  select "2-Test Outputs", then press  to confirm.

From here starts the sequence of tests listed below.

Repeatedly pressing the key  activates **ON** and **OFF** one after another all Led: LGreen, LYellow, LRed, the Buzzer and the outputs relay: the PRE1, PRE2, ALL and FAULT.

Finally, will be displayed the Battery voltage, with activation of the internal test "load".

Module AL101 (lead battery) - this value should be about 12VDC

Module AL102 + BA100 (Lithium battery) this value should be about 10.5 Vdc

***WARNING: Test Battery, must obviously be only used when the modules are installed AL101 or AL102. Do not leave this test active for more than a minute. During the test is activated, the "load" to the internal CE100, consisting of power resistors which obviously will become hot.***

### MENU PRINCIPALE

7 Code  
8 Protected Menu  
9 Service

### Service

1 Test Inputs  
2 Test Outputs  
3 Language



### Test Inputs



1=04.0mA      2=04.0mA  
3=04.0mA      4=04.0mA  
5=04.0mA      6=04.0mA

### Test output

LGreen

## SETTING THE LANGUAGE

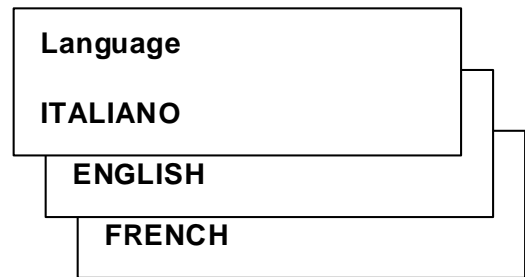

With key  select "3-Language" and press  to confirm

With keys   you can change the language and pressing  confirms the choice.



## APPENDIX

### LIST OF ANOMALY MESSAGES AND ALARMS

<u>NO SENSORS CONFIGURED</u>	The central system is not configured.
<u>FAULT-</u>	The input signal is less than 1 mA. The sensor could be faulty, not connected or not powered.
<u>UNDERFLOW</u>	The input signal is between 1 and 3,5mA. The detector could be out of calibration on the beginning of the scale.
<u>PRE1</u>	The 1 <sup>st</sup> alarm threshold has been exceeded and the related output relay is active (if configured).
<u>PRE2</u>	The 2 <sup>nd</sup> alarm threshold has been exceeded and the related output relay is active (if configured).
<u>AL</u>	The 3 <sup>rd</sup> alarm threshold has been exceeded and the related output relay is active (if configured).
<u>OVERFLOW</u>	The input signal is between 21 and 24 mA. The sensor is detecting gas, but the full scale has been exceeded.
<u>FAULT+</u>	The input signal is greater than 24 mA. The sensor could be faulty, or it's detecting gas but it has exceeded its full scale.
	<i>Mains 230Vac power supply is missing.</i>
	<i>Battery empty.</i>
	The valve with Position sensor is not close.
<u>Display switched off</u>	if the green Led is ON, the Display could be damaged or the contrast is too low, tries to regulate it with the trimmer on the Board: ("Contrast ADJ" bottom right corner) placed in the CE100 housing, on the PCB placed into the front cover.

### LIST OF ACOUSTIC AND OPTICAL SIGNALS

<u>Intermittent Buzzer</u>	One of the detectors has exceeded the 3 <sup>rd</sup> Alarm Level (ALL) or the AUX input is active.
<u>Green Led on</u>	Mains power supply ON (normally working condition).
<u>Green Led Blinking</u>	The CE100 is powered by the Battery; the Mains is OFF.
<u>Red Led on</u>	One of the sensors has exceeded the 3 <sup>rd</sup> Alarm level (AL3).
<u>Red Led Blinking</u>	One of the Detectors has exceeded the 1 <sup>st</sup> Alarm and/or 2 <sup>nd</sup> Alarm levels (AL1 and/or AL2) or one of the <i>Latched Output</i> relay has been activated.
<u>Yellow Led Blinking</u>	Battery voltage is less than 10.8Vdc.
<u>Yellow Led on</u>	One of the sensors is <i>FAULT+</i> (>24mA) or <i>FAULT-</i> (0 mA).
<u>Green Led and Display OFF</u>	Mains power supply OFF, and battery has powered the central system till it got down. If the battery voltage gets down under 10VDC, it is automatically disconnected to avoid damages.

## TECHNICAL CHARACTERISTICS

<b>Technical Characteristics central system Mod. CE100</b>	
Power Supply	12÷24VDC (-10/+15%)
Maximum absorbed power at 24VDC	15W with 6 Sensors series TS293P
Inputs	No.2 analogue Linear 4÷20 mA (Max. scale 0÷9999) No.1 ON/OFF active when the contact is Closed.
Internal Resistance of inputs charge	200 ohm ( <i>referred to ground</i> )
Detectors power supply	20 Vcc (-10/+15%)
Outputs	No. 4 relays with one Voltage free exchange contact
Relay Capacity	3A resistive (1A inductive) - 230 Vac
Working Temperature with Battery	+5 ÷ +40 °C
Buffer Battery	Modules AL101 or AL102 + BA200
Battery Life	<i>See AL101 and AL102 technical characteristics.</i>
Display	Amber Back lighted Graphic LCD
Keyboard	No. 4 keys
Dimensions (l x h x p)	90x60x71 / no.4 DIN modules
Weight	About 195 grams

<b>Technical Characteristics Expansion CE101 (*)</b>	
Inputs	No. 2 analogue Linear 4÷20 mA
Internal Resistance of inputs charge	200 ohm ( <i>referred to ground</i> )
Detectors power supply	20 Vdc (-10/+15%)
Dimensions (l x h x p)	90x60x35 / no.2 DIN modules
Weight	About 57 grams

<b>Technical Characteristics Supply Module AL100</b>	
Mains Power Supply	230 VAC (-15/+10%) - 50 Hz (±10%)
Output supply	20Vcc
Minimum power consumption at 230V	8VA with n.2 detectors series TS293P
Power consumption at 230V	12VA with no.4 detectors series TS293P
Max power consumption at 230V	15VA with no.6 detectors series TS293P
Dimensions (l x h x p)	90x60x52 / no.4 DIN modules
Weight	about 440 grams

<b>Technical Characteristics of Lead Battery charger AL101</b>	
Mains Power Supply	230 VAC (-15/+10%) - 50 Hz (±10%)
Max power consumption at 230V	15VA with Battery and 12Vdc/12W max Valve
Battery power voltage	13.8 Vdc
Lead Battery (on request)	12 Vdc - 3 Ah (152 x 65 x 94mm)
Battery life	About 3 hours (with 6 sensors series TS293P and a 12Vdc/12W Gas Valve).
Dimensions (l x h x p)	90x60x52 / n.4 DIN modules
Weight	about 440 grams

<b>Technical Characteristics of Lithium Battery charger AL102</b>	
Mains Power Supply	230 VAC (-15/+10%) - 50 Hz (±10%)
Max power consumption at 230V	15VA with Battery and 12Vdc/12W max Valve
Lithium battery	Module BA100
Dimensions (l x h x p)	90x60x52 / n.4 DIN modules
Weight	About 440 grams

<b>Technical Characteristics of Lithium Battery BA100</b>	
Supplied voltage	10.8Vdc
Batterie life	About 40 minutes (with 6 sensors series TS293P and a 12Vdc/12W Gas Valve).
Dimensions (l x h x p)	90x60x52
Weight	About 300 grams

## CONFIGURABLE 4÷20 mA DETECTORS TABLES

MODEL	GAS	Scale	Units	Suggested Alarm Levels		
				PRE1 <sup>(2)</sup> Level 1	PRE2 Level 2	ALL Level 3
<b>TS220EA</b> (TS293EA)	NH <sub>3</sub>	0-300	ppm	10 <sup>(3)</sup>	20	50
<b>TS220EC</b> (TS293EC)	CO	0-300	ppm	25 <sup>(2)</sup> -50	100	200
<b>TS220EH</b> (TS293EH)	H <sub>2</sub> S	0-100	ppm	10	20	50
<b>TS220EN</b> (TS293EN)	NO	0-100	ppm	10	20	50
<b>TS220EO</b> (TS293EO)	O <sub>2</sub>	0-25.0	% vol	18,5 <sup>(3)(4)</sup>	19,5 <sup>(4)</sup>	22.5
<b>TS220ES</b> (TS293ES)	SO <sub>2</sub>	0-100	ppm	7 <sup>(3)</sup>	20	50
<b>TS292KG</b>	GPL	0-20	% LEL	6 <sup>(3)</sup>	15	20
<b>TS292KM</b>	Methane	0-20	% LEL	7 <sup>(3)</sup>	15	20
<b>TS292KX</b> (TS292KB, TS292KI)	Inflammables	0-20	% LEL	6 <sup>(3)</sup>	15	20
<b>TS293KG</b>	GPL	0-20	% LEL	7 <sup>(3)</sup>	15	20
<b>TS293KM</b>	Methane	0-20	% LEL	6 <sup>(3)</sup>	15	20
<b>TS293KX</b> (TS293KB, TS292KI)	Inflammables	0-20	% LEL	7 <sup>(3)</sup>	15	20
<b>TS292Px<sup>(1)</sup></b> (TS292PM, TS292PG, TS292PI, TS292PB)	Inflammables	0-100	% LEL	7 <sup>(3)</sup>	10÷15	20÷30
<b>TS293Px<sup>(1)</sup></b> (TS293PX-S, TS293PX-H, TS293PE, TS293PS)	Inflammables	0-100	% LEL	6 <sup>(3)</sup>	10÷15	20÷30
<b>IR101</b>	CO <sub>2</sub>	0-2.00	% vol	0.20	0.50	1
<b>IR102</b>	CO <sub>2</sub>	0-2.00	% vol	0.20	0.50	1
<b>Generico</b>						

- (1) The sensors are calibrated with TS293P Series FS 100% LEL only change the calibration gas.
- (2) When required.
- (3) It is recommended to set warning levels below the indicated value.
- (4) Alarm Descending read the NOTES on page 17.
- (TS ..... ) The models shown in brackets, are the operating characteristics identical to the first highlighted in bold, the only difference is the type of protective custody.

### Connecting Detectors 4-20mA two-wire products up to December 2008

- **NOTE:** of course, can also be connected all the previous models produced up to December 2008. That is, the detector 4-20mA linear 3-wire for flammable gases, TS292K series (IP65) or TS293K (explosion proof) with a scale of 0 to 20% LEL, or series TS293P (Ex "d") with scale 0 to 100% LEL. Detector 4-20mA linear two-wire, detectors with electrochemical cell, for toxic gases and oxygen, TS220E series (IP65).

The connection with detector 4 to 20 mA two-wire, it should be done (fig.7) between the terminals "+" and "-" the detector, and the respective terminals "+" and "S" on the control panel inputs.

The section of the connecting cables between the central unit and detectors must be suited to the distance, as shown in Table. We recommend the use of shielded cables, the screen (shield) is connected only by the central side and a single point of "GROUND".

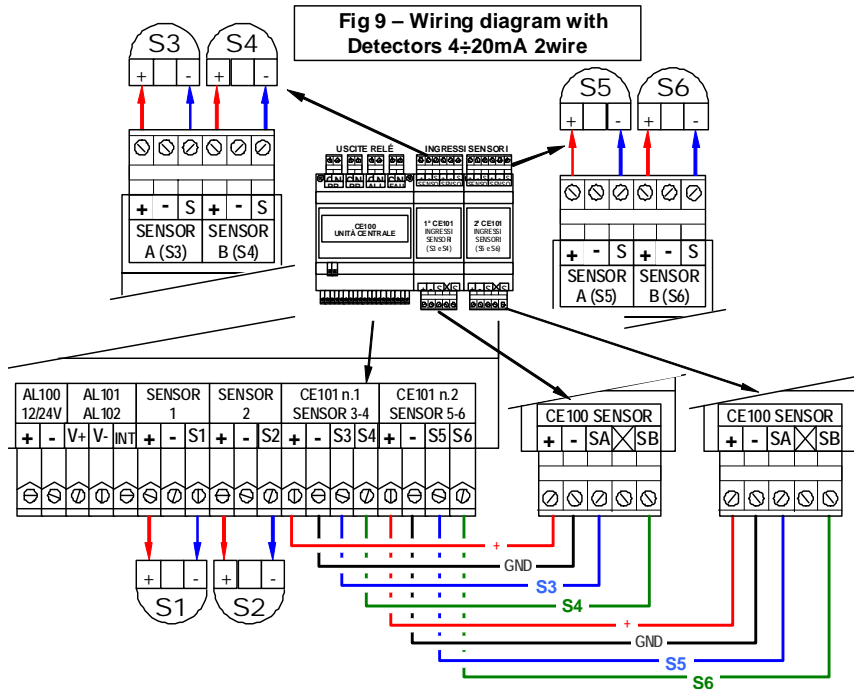

Detectors series TS210E e TS220E	
Distance	Typo of Cable
from 0 up to 100 meters	3x0,5 mm <sup>2</sup> Shielded
from 100 up to 200 meters	3x1 mm <sup>2</sup> Shielded
from 200 up to 500 meters	3x1,5 mm <sup>2</sup> Shielded
from 500 up to 1000 meters	3x2,5 mm <sup>2</sup> Shielded



## SETUP MEMORANDUM TABLES

We suggest filling these tables as a memorandum of the configuration you set up. Moreover it will be better to make a copy of these datas, adding it to the central system (Eliminating the section "Code") and another complete copy to the central system documentation.

MODULES	CE100		1st CE101		2nd CE101	
	S1	S2	S3	S4	S5	S6
Sensor Number						
Sensor Model						
Full Scale (0÷9999)						
Unit (LIE, %, ppm o °C)						
1st Level PRE1 (PREalarm 1)						
2nd Level PRE2 (PREalarm 2)						
3rd Level ALL (ALarm)						
Output Relay PRE1 - Delay ON (0÷4 min.)						
Output Relay PRE1 - Delay OFF (0÷30 min.)						
Output Relay PRE1 - Time ON (0÷30 min.)						
Output Relay PRE1 - Logic Positive (NO/SI)						
Output Relay PRE1 - Memorization (NO/SI)						
Output Relay PRE2 - Delay ON (0÷4 min.)						
Output Relay PRE2 - Delay OFF (0÷30 min.)						
Output Relay PRE2 - Time ON (0÷30 min.)						
Output Relay PRE2 - Logic Positive (NO/SI)						
Output Relay PRE2 - Memorization (NO/SI)						
Output Relay ALL - Delay ON (0÷4 min.)						
Output Relay ALL - Delay OFF (0÷30 min.)						
Output Relay ALL - Time ON (0÷30 min.)						
Output Relay ALL - Logic Positive (NO/SI)						
Output Relay ALL - Memorization (NO/SI)						
Output Relay FAULT - Delay ON (0÷4 min.)						
Output Relay FAULT - Delay OFF (0÷30 min.)						
Output Relay FAULT - Time ON (0÷30 min.)						
Output Relay FAULT - Logic Positive (NO/SI)						
Output Relay FAULT - Memorization (NO/SI)						

### NOTES:

---



---



---



---



---



---



---



<i>Date of first Installation</i>	<i>Serial Number</i>
CODE LEVEL 2	SN: CODE LEVEL 3

**ATTENTION:** we suggest writing (max. 4 numbers) and storing the code in a safety place. In case the Code gets lost, contact our Service Dept. That will give an emergency Code.

**Informazione / Information / Information**

Il simbolo di riciclaggio, indica che alla fine della vita utile, il prodotto dovrà essere smaltito separatamente in appositi luoghi di raccolta e non assieme ai normali rifiuti. Questo evita possibili effetti negativi sull'ambiente e sulla salute e favorisce il riciclo dei materiali di cui è composta l'apparecchiatura.

The recycling symbol means that at the end of the life of the equipment you must dispose of it separately at an appropriate collection point and not place it in the normal unsorted waste stream. This will benefit the environment for all.

Le symbole représenté, signifie, qu'en fin de vie, cet équipement ne doit pas être mélangé à vos ordures ménagères, mais doit être déposé dans un point de collecte prévu pour les déchets des équipement électriques. Votre geste préservera l'environnement.