



# HF-2700A / HF-2500A

## High Frequency Welding Control

### HIGH RELIABILITY MICROJOINING

The HF Series high frequency weld controls address the challenges of **micro welding** for a wide range of applications. Precise control of weld energy with high speed closed loop feedback and weld quality tools ensure high yields for the most demanding welding applications.

HF Series weld controls are also geared for automation featuring exceptional repetition rates, standard I/O connections and remote programming capability.

### KEY FEATURES

#### CONTROL FEATURES:

- Constant current, voltage, and power modes
- Monitors energy and resistance
- 2400 A maximum
- 25 kHz feedback

#### WELD QUALITY PROCESS TOOLS:

- Active Part Conditioning (APC)
- Pre-Weld Check
- Weld to Limits

#### HF-2700A ADVANCED FEATURES:

- Displacement and force monitoring
- Force control
- Envelope function
- Combo mode
- Energy and time limits

### TYPICAL APPLICATIONS

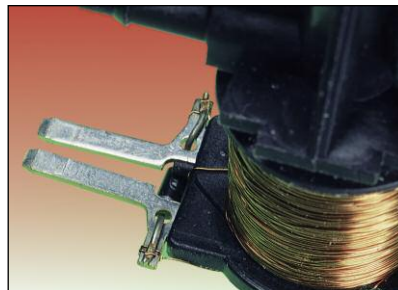

*Anti-lock brake system solenoid*



*Critical parts fabrication*

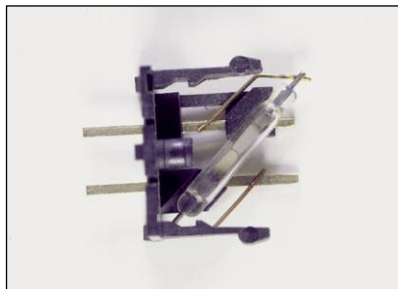

*Switch assembly*



*Implantable device interconnects*



## INTUITIVE, EASY-TO-USE PROGRAMMING

- Intuitive graphical user interface.
- Dual pulse waveforms programmed in current, voltage, or power control modes.
- Programming times to 100 µsec increments provides ultimate control.
- Accurate, built-in monitor displays the graphical “trace” of weld current, voltage, power and resistance, along with numerical peak and average values.
- Easy-to-set limits establish process window for acceptable quality.
- User programmable relays can be used in conjunction with visual and audible signals for operators and automation interface.

## CURRENT, VOLTAGE AND POWER FEEDBACK MODES:

### Constant Voltage: - - - - -

- Compensates for parts misplacement and force problems
- Reduces weld splash
- Ideal for round (non-flat) parts

Monitor current

### Constant Power: - - - - -

- Varies current and voltage for consistent energy
- Breaks up surface oxides and plating
- Ideal for automation to extend electrode life

Monitor current or voltage

### Constant Current: \_\_\_\_\_

- Delivers same current regardless of resistance changes
- Compensates for part thickness changes
- Ideal for flat parts with consistent electrode to part fit-up

Monitor voltage

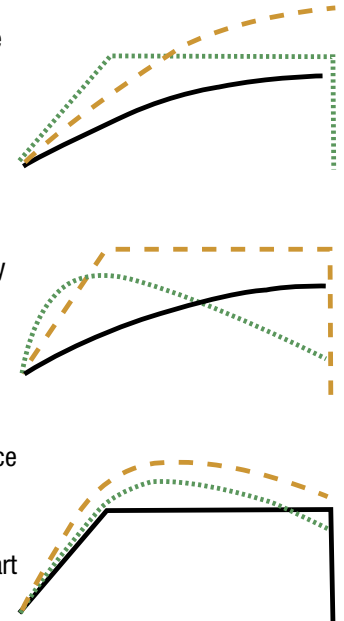

## EFFECTIVE WELD MONITORING AND PROCESS TOOLS

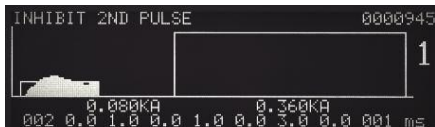

Run screen – shows that second pulse was inhibited from firing.

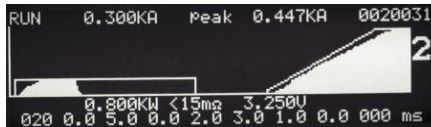

Run screen – constant power first pulse breaks through oxides.

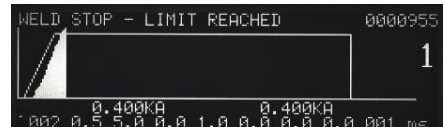

Run screen – shows termination of weld current during weld pulse.

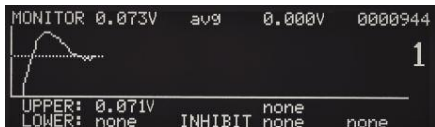

Monitor screen – shows first pulse weld voltage exceeded limit.



Monitor screen – first pulse time automatically compensates for varying levels of oxides.



Monitor screen – shows weld voltage exceeding limit.

## PRE-WELD FUNCTION

Sends an initial short, low energy pulse through the assembly, tests key electrical parameters against pre-set limits, and inhibits operation if limits are exceeded.

### Advantages

- Prevents unacceptable welds
- Prevents electrode damage
- Alerts operator to weld fault
- Relay outputs can signal automation

## ACTIVE PART CONDITIONER (APC)

First pulse adapts weld time to displace oxides then terminates allowing a second pulse with upslope to complete the weld, thus avoiding weld splash.

### Advantages

- Brings each part to the same resistance prior to application of welding current
- Provides for consistent welding of difficult-to-weld oxidized parts
- Prevents weld splash
- Increases process yields

## WELD STOP

Terminates the weld energy during the welding process if pre-set weld current or voltage limits are exceeded.

### Advantages

- Prevents blow-outs and parts damage
- Prevents electrode damage
- Alerts operator to weld fault
- Relay outputs can signal automation

## ADVANCED PROCESS FEATURES

### HF-2700A Precisely Controls and Monitors Electrical and Mechanical Weld Parameters

#### Displacement

- Initial thickness (part detection)
- Final thickness
- Weld displacement (set down)
- Energy stop (weld to limit)

Measurement of initial part thickness can confirm parts are present and aligned for welding. Settings limits on the mechanical displacement can confirm the electrical parameters have produced the correct part displacement and can also prove a good indication of weld quality.

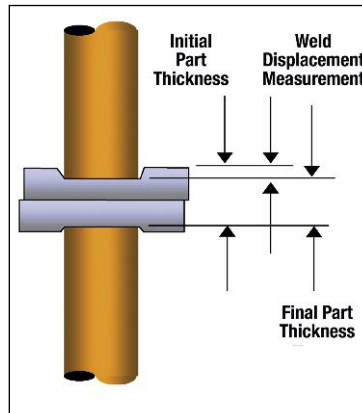

LVDT provides vital process data

```
LVDT POSITION +430 0000276
          LO LIM HI LIM LAST
INITIAL  +048 058 +054 STOP 1
FINAL    +000 +000 +047
DISPLC   +000 000 +007 13.0%
STOP ENERGY AT 004 IN/1000
NEW ELECTRODE: IS SET
SCHEDULE edit, RUN Run
```

LVDT screen – program limits and view results

```
< LVDT WHEN >
1. ANY 6. DISPLACEMENT LO
2. INITIAL LO 7. DISPLACEMENT HI
3. INITIAL HI 8. INITIAL NG
4. FINAL LO 9. DISPLACEMENT NG
5. FINAL HI 0. STOP ENERGY AT
NUMBER Select, MENU Previous menu
```

Program relay outputs to signal automation

#### Envelope

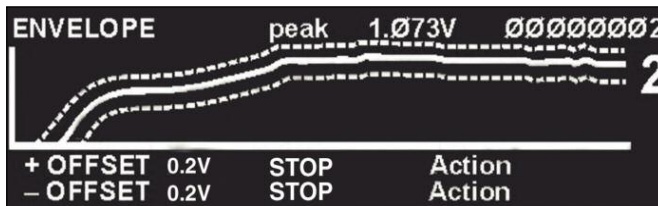

The **envelope limits** function enables upper and lower limits to be placed around an optimized weld signature. Any deviation across the envelope results in an alarm, and a specified action. This feature can detect even slight changes in the process that could lead to inconsistent welds. This high level of verification is preferred in many medical device and automotive welding applications, which must meet strict process control and quality requirements.

## ADVANCED CONTROL MODES



**Force control** is accomplished using a proportional valve to set the air pressure on a pneumatic weld head. Force settings are schedule dependent, matched to different applications. Force control can increase production rates by reducing down time and improving cycle times in automated systems.

The **force monitor** through a weld head mounted load cell eliminates the time consuming task of repeatedly verifying electrode forces on production lines with multiple welding stations.

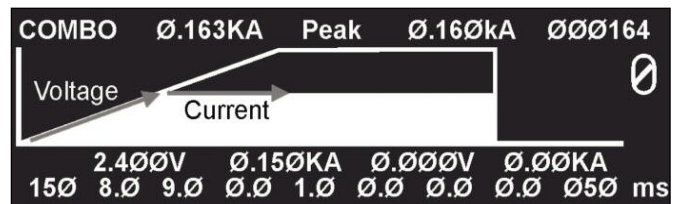

The **combo function** allows a weld to be initiated in voltage or power mode, then switch to constant current when a preset limit is reached. The combo mode can reduce the occurrence of weld splash and over-melting of the parts. Typical applications for the combo mode include wire welds, tang welds, and motor fusing.

## EXPANDED MONITORING OPTIONS

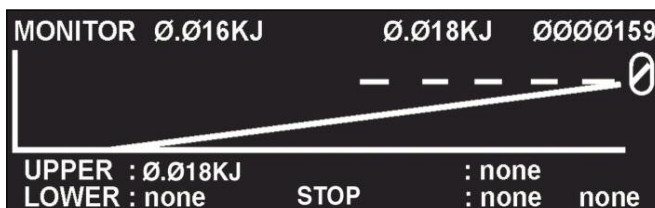

The **weld energy monitor** calculates the energy in Joules that is delivered to each weld. This feature indicates changes in weld energy, and is typically implemented for operator dependent, manual welding stations where part fit-up can vary.



Arrows to select field, RUN or MENU

**Time limits** can be programmed when welding to displacement or electrical limits. Monitoring the actual weld time can ensure consistency, adding an additional safety net to the weld process.



## TECHNICAL SPECIFICATIONS

Model Number	HF-2500A/240	HF-2500A/400	HF-2500A/480	HF-2700A/240	HF-2700A/400	HF-2700A/480
Nominal line voltage (3 phase)	240 VAC	400 VAC	480 VAC	240 VAC	400 VAC	480 VAC
Line voltage range (VAC)	192 to 264	320 to 440	384 to 528	192 to 264	320 to 440	384 to 528
Input circuit rating (per phase)	25 A	20 A	13 A	25 A	20 A	13 A
Input kVA @ 3% duty cycle	30 kVA					
Output kW @ max. demand	12 kW					
Output transformer voltage @ max. rated output current	5.2 V					
Open circuit max. output voltage @ nominal line	11.5 V					
Setting ranges	Current – 100 A to 2400 A; Voltage – 0.2 V to 10 V; Power – 50 W to 10 kW					
Output current	2400 A @ 3% duty cycle					
Output feedback response time (current, voltage, power)	40 µs					
Output regulation versus line voltage variance	2%					
Output regulation versus load resistance variance	2%					
Output repeatability current, voltage, power ± of setting	2%					
Weld period ranges	All segments except squeeze and hold 0.10 ms to 10 ms, 0.1 ms steps; 10 to 99 ms, 1 ms steps; squeeze and hold 0 to 999 ms, 1 ms steps					
Weld energy setting accuracy	Current: 2% of setting or 2 A, whichever is greater; Voltage: 2% of setting or 0.050 V, whichever is greater; Power: 5% of setting or 20 W, whichever is greater					
<b>Weld Heat Profile Functions</b>						
Weld pulse control	Dual pulse with independent control of current, voltage, power or combo mode (HF-2700A) on each pulse.					
Programmable weld pulse segments	Squeeze, upslope 1, weld 1, downslope 1, cool, upslope 2, weld 2, downslope 2, hold.					
Weld schedule memory	Save up to 100 different weld schedules, protected from unauthorized changes.					
Measurement parameters	Independent monitor of current, voltage, power, and resistance on each pulse. Envelope, time limits and energy monitor (HF-2700A).					
Graphic display	Back-lit LCD displays programmed and actual weld current, voltage or power, upper and lower limits, and resistance.					
Measurement selection	Peak or average					
Current measurement range/accuracy	50.0 A to 2.400 kA/±2% of reading or ±2 A, whichever is greater.					
Voltage measurement range/accuracy	0.2 V to 9.999 V/±2% of reading or ±0.05 V, whichever is greater.					
Power measurement range/accuracy	0.01 KW to 9.999 kW/±5% of reading or ±20 W, whichever is greater.					
Alarms	Display alert, four user programmable AC/DC relays; audio alarm.					
Programmable weld energy limit	Terminates weld energy when exceeding user defined current, voltage, or power limits.					
Weld pre-check	Inhibit second weld pulse when first test pulse exceeds user programmed limits.					
Active part conditioner	First pulse current limit in constant power allows second pulse to fire.					
<b>I/O and Data Communications</b>						
Input	All inputs and outputs are fully isolated.					
Input isolation	Selectable: +5 V, +24 V, sourcing or sinking inputs.					
Control voltages	1-level foot switch, 2-level foot switch, mechanical or opto firing switch.					
Firing switch initiation	Remote weld schedule select, process inhibit, emergency stop.					
Remote control	Change weld schedules and individual parameters.					
RS232	Change weld schedules and individual weld parameters; "Daisy Chain" unit to unit, unit(s) to host computer.					
RS485	Weld voltage signal for voltage feedback operation (0 to 10 V peak).					
Electrode voltage						
Weld head air valve driver	24 VAC, 1 A; timing controlled by HF-2500A/HF-2700A. Operates new EZ-AIR®.					
Alarm relays	Four user-programmable mechanical relays; programmable normally open or normally closed; contacts: 250 VAC at 5 A; 30 VDC at 5 A. Conditions: weld, end of weld, alarm, out of limits.					
<b>Displacement Option (HF-2700A only)</b>						
Capabilities	Part detection, final thickness measurement, set down measurement, energy stop (weld to limit)					
Accuracy of displacement readings	± 0.003 in (0.076 mm)					
Repeatability	± 1.0 %					
Maximum travel	1 in (25 mm)					
Alarm relays	Additional conditions: any LVDT, initial Lo/Hi, final Lo/Hi, displacement Lo/Hi, initial NG, displacement NG, energy stop					
Data output	Initial thickness, final thickness, displacement, and any alarm condition					
80DSPK	Attaches to TL Series weld heads. Includes LVDT, interface cable, and mount					
<b>Force Control and Monitor (HF-2700A)</b>						
Force input	0 - 10 V input signal from signal conditioner or load cell					
Force measurement	End of squeeze, end of hold					
Force output	0 - 10 V for use with proportional valve					
Force programming	lbs, kg. N. force can be stored by schedule					

## WEIGHT &amp; DIMENSIONS

Dimensions (L x W x H)	18 in x 9 in x 12.8 in (460 mm x 230 mm x 325 mm)
Weight	54 lb (25 kg)



## AMADA WELD TECH INC.

1820 S. Myrtle Ave. • Monrovia, CA 91016 US  
T: (626) 303-5676  
[info@amadaweldtech.com](mailto:info@amadaweldtech.com) • [www.amadaweldtech.com](http://www.amadaweldtech.com)  
ISO 9001 Certified Company • 24/7 Repair Service: 1-866-751-7378

## AMERICAS

AMADA WELD TECH  
(Midwest Technical Center)  
Detroit, Michigan  
T: (248) 313-3078  
[midwestsales@amadaweldtech.com](mailto:midwestsales@amadaweldtech.com)

AMADA WELD TECH DO  
LTD.A.  
São Paulo, Brasil  
T: +55-11-4193-3607  
[antonio.ruiz@amadaweldtech.com](mailto:antonio.ruiz@amadaweldtech.com)

## EUROPE

AMADA WELD TECH  
GmbH  
Munich, Germany  
T: +49-89-839403-0  
[info@amadaweldtech.eu](mailto:info@amadaweldtech.eu)

## ASIA

AMADA WELD  
TECH CO., LTD.  
Isehara, Japan  
T: +81-4-7125-6177  
[sales@miyachi.com](mailto:sales@miyachi.com)

AMADA WELD TECH  
KOREA CO., LTD.  
Seoul, Korea  
T: +82-31-8015-6810  
[sales@amadaweldtech.co.kr](mailto:sales@amadaweldtech.co.kr)

AMADA  
(THAILAND) CO., LTD.  
Bangkok, Thailand  
T: +66-2170-5900  
[info@amada.co.th](mailto:info@amada.co.th)

AMADA WELD TECH  
INDIA PVT., LTD.  
Bangalore, India  
T: +91-80-4092-1749  
[info@miyachiindia.com](mailto:info@miyachiindia.com)

AMADA WELD TECH  
(Mexico Office)  
El Paso, Texas  
T: (915) 881-8765  
[mxsales@amadaweldtech.com](mailto:mxsales@amadaweldtech.com)

AMADA WELD TECH  
SHANGHAI CO., LTD.  
Shanghai, China  
T: +86-21-6448-6000  
[jwu@msc.miyachi.com](mailto:jwu@msc.miyachi.com)

AMADA WELD TECH  
TAIWAN CO., LTD.  
Taipei, Taiwan  
T: +886-2-2585-0161

AMADA  
VIETNAM CO., LTD.  
Ha Noi, Vietnam  
T: +84-4-6261-4583

Specifications subject to change without notice. Copyright© 2020 AMADA WELD TECH INC. The material contained herein cannot be reproduced or used in any other way without the express written permission of AMADA WELD TECH INC. All rights reserved.

follow us on:

