

Brief Description / Applications

- Controller for all kind of Storages, such as Walk-In Coolers/Freezers, Refrigerated Shelves, Refrigerated Counters, Refrigerated Cases, etc.
- For standard cold storages or cold storages with pulse-width modulated expansion valves, expansion valves with thermal drive and stepper motor valves (with additional EVS module)
- For single or network operation
- 5 Temperature sensors, 5 Relays, 4 Digital Inputs, Analogue In-/Output

Standard Functions

- Controls temperature, defrost device, evaporator fans, roller blinds, etc.
- Up to 3 evaporators with a single device
- For further control circuits up to 5 EVP can be connected as slaves
- 2 expansion Valve control methods selectable
- Valve control is fully autoadaptive
- Foresight control and condenser pressure optimization in cooperation with the VPR compressor compounds central unit
- Intelligent defrost control, able to learn, no additional sensors
- Defrost Start fully automatic, by 8 release times or manually
- Defrost cycle is pulsed, controlled by evap sensor (variable intervals)
- Automatic recognition of the leading evaporator
- Emergency Mode if sensor or defrost recognition fails.
- Autoreset after repair
- Use of Latency Heat by intelligent fan control



ELREHA

ELEKTRONISCHE REGELUNGEN GMBH

Technical Manual **5311437-00/09e/00**

**Cold Storage
Controller**

2018-06-22, tkd/jr

from SoftVers. 1.10

Type: **EVP 3167**



In controllers which contain older software versions, some functions may not be available!

Operating / Operating Elements

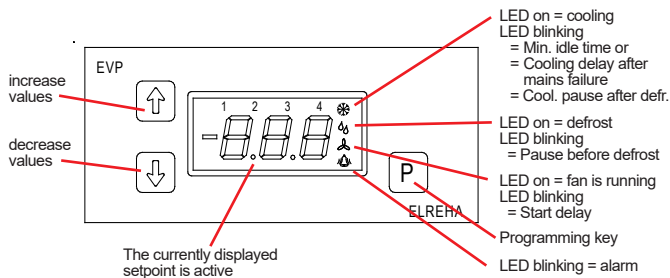

The current states of the digital inputs, the relays and the data transmission can be read on the Actual Values Page under L60 and L61.

LEDs: are blinking the same time = control functions are disabled by digital input or via interface

3 keys allow programming the unit, all parameters will be displayed on the red LED-7-segment display. 4 red symbols at the right side indicate specific control functions (not the relay states, these are displayed on the 'Actual Page'!).

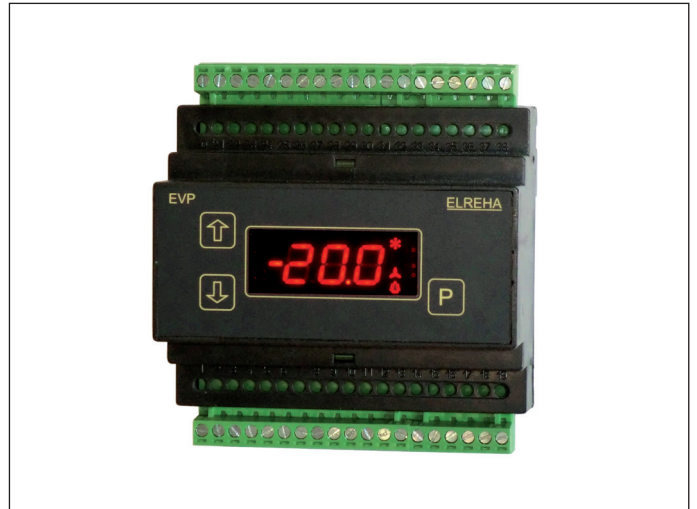

Programming

All parameters of the **EVP** are distributed on different pages. While normal operation or if no key is pressed for about 3 minutes, the **EVP** displays the following information:

- 1st priority: current failure (blinking)
2nd priority: operating states (e.g. 'oFF')
3rd priority: selected 'permanent parameter' display

Selecting and Changing of Parameters

key	action
P (> 2 sec.)	Page name will be displayed
↑ ↓	Select desired page
P	Enter the page
↑ ↓	Select parameter
P	Prepare programming. Enter access code if necessary
↑ ↓	Change value.
	If you hold the key, the values change faster and faster
P	Confirm programming
P (> 2 sec.)	Page name will be displayed again

Access Protection

Except the temperature setpoints, parameters can be changed only after entering a correct access code. If you want to change such a parameter after pushing the "P"-key, then the following display appears:

Now the controller expects the entry of a code number .

This code number is always 88. Enter it by the up/down keys and confirm it by pressing "P" again.

If no key is pushed for about 3 minutes, the code number must be entered again.

Manual Defrost

- Start manual defrost: - Select "d50" (Defrost Page),
- Set it to "on" and confirm.
- Stop manual defrost: - Select "d50" (Defrost Page),
- Set it to "oFF" and confirm.

Parameter Pages

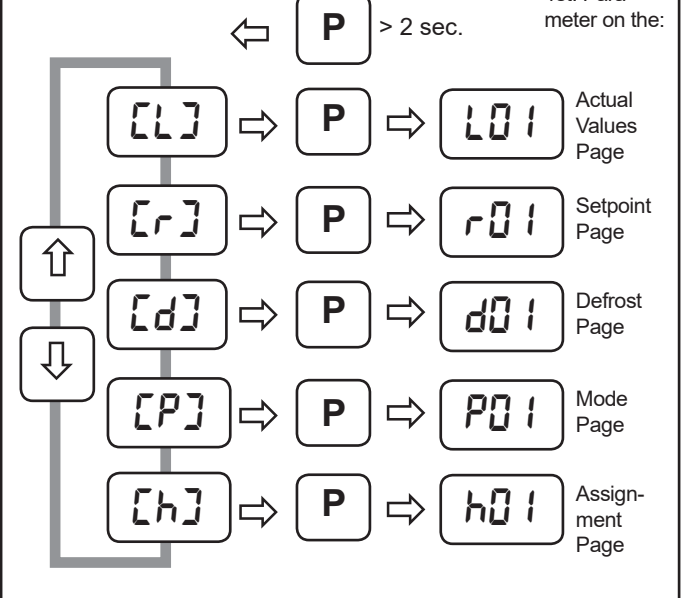

Please note safety instructions !

DANGER

Technical Data

Supply Voltage.....EVP 3167.....230V, 50-60Hz, max. 9VA (controller only)
 Ambient Temperature0...+50°C
 Max. Ambient Humidity85% r.F., not condensing
 Analogue Inputs 5x Temperature Sensors TF 201 (PTC)
 or TF 501 (Pt 1000), as well as customer specific probes
 1x pressure transducer 0(2)-10V (scalable), Ri=69 kOhm
 Measuring ranges..... TF 501 (Pt1000).....-100°C...+100°C
 of the probe inputs TF 201 (PTC, 2 kΩ at°C).....-50°C...+100°C
 So1-40°C...+25°C
 So2-50°C...+50°C
 TF 202 (PTC, 990 Ω at 25°C).....-55°C...+100°C

 **The temperature ranges of the probe heads and cables must be observed !**

Accuracy ±0.5K in range -35...25°C within the ambient temperature range 10...30°C
 Digital Inputs4x mains voltage, 3mA max. overvoltage category II, pollution degree 2
 Relay Outputs1x SPDT, 3x SPST, isolated, 8A res/3A ind./250V overvoltage category III, pollution degree 2
 SSR-Output (e.g. for EEx-Valve) 1x Solid-State-Relay (SSR), max. 0,5 A / 250VAC overvoltage category III, pollution degree 2

 **Please note the information at the connection plan about a necessary snubber circuit at the SSR output!**

Transducer Supply 22V DC ±10%, 40 mA max.
 Analogue Output.....0...10V or 4...20mA (selectable)
 0...10VDC, max. current typ. 1mA
 4...20 mA, max. shunt resistance 250 ohms
 Display/Parameter Ranges see parameter pages
 Data Interfaces 3x RS 485
 Data storageunlimited
 Real Time Clockautomatic summer/winter switch
 10 days clock backup without mains voltage
 Housing.....plastic with foil keypad for rail mounting (DIN EN 50022), screw terminals 2,5 mm

Accessories

- Temperature probe TF 501, quantity depends on application
- Pressure Transducer "DG -1/9 2-10V" with 2-10VDC output
- PC-Software "**CV-Scheduler**" for configuration via VPR or SMZ Systems.

CONNECTION INFORMATION & SAFETY INSTRUCTIONS



The guarantee will lapse in case of damage caused by failure to comply with these operating instructions! We shall not be liable for any consequent loss! We do not accept liability for personal injury or damage to property caused by inadequate handling or non-observance of the safety instructions! The guarantee will lapse in such cases.

This manual contains additional safety instructions in the functional description. Please note them!



If you notice any damage, the product may not be connected to mains voltage! **Danger of Life!**

- A riskless operation is impossible if:
- The device has visible damages or doesn't work
 - After a long-time storage under unfavourable conditions
 - The device is strongly dragged or wet
 - After inadequate shipping conditions
- Never use this product in equipment or systems that are intended to be used under such circumstances that may affect human life. For applications requiring extremely high reliability, please contact the manufacturer first.
- **The product may only be used for the applications described on page 1.**
 - **Electrical installation and putting into service must be done from qualified personnel.**
 - **During installation and wiring never work when the electricity is not cut-off ! Danger of electric shock!**
 - **To prevent electrical shock, the device may only be operated in a closed control cabinet or control box.**
 - **Never operate unit without housing. Danger of electric shock!**
 - **All 'PE' terminals must be connected to PE. Danger of electric shock!** Additionally, the internal noise filter will not work, faulty indicated values may occur.
 - Please note the safety instructions and standards of your place of installation!



- Before installation: Check the limits of the controller and the application (see tech. data). Check amongst others:
 - Make sure that all wiring has been made in accordance with the wiring diagram in this manual.
 - Supply voltage (is printed on the type label).
 - Environmental limits for temperature/humidity.
 - Maximum admitted current rate for the relays. Compare it with the peak start-up currents of the controlled loads (motors, heaters,etc.).
 Outside these limits malfunction or damages may occur.
- Sensor/probe cables must be shielded. Don't install them in parallel to high-current cables. Shielding must be connected to PE at the end close to the controller. If not, inductive interferences may occur.
- Please note for elongation: The wire gauge is not critical, but should have 0,5mm² as a minimum.
- Mounting the controller close to power relays is unfavourable. Strong electro-magnetic interference, malfunction may occur!
- Take care that the wiring of interface lines meets the necessary requirements.
- All used temperature sensors must be identical. Never use different types at the same time. This will not work.
- TF-type sensors are not designed for being immersed in fluids permanently. In such a case, always use dip-fittings. With extreme temperature variations, the sensor may be damaged.



Cleaning
 The use of a dry, lint-free cloth and household agents is sufficient to clean the product.
 Never use acids or acidic fluids! Risk of damage!

Display of actual values and states

All actual values are shown on the "Actual Values Page" (L J).

State of the controller unit

If the 4 status LEDs are blinking simultaneously and the display shows "oFF", the control functions are disabled by digital input or data interface.

Display of temperatures

"L01" - "L05" (Actual Values Page) show the actual temperature value of the sensors 1-5 in a range within -100... +100°C. "L06" shows a temperature value which is calculated from the pressure value of the transducer and the selected refrigerant table, "L07" shows the pressure and "L08" the 'virtual' temperature value. With "P31"-"P36" (Mode Page) this displays can be calibrated.

Expansion Valve Status Display

L52 shows the state of EEx-Valves, L53 the state of Stepper Motor Valves. The current, average aperture size from 0...100 % and additionally the actual state of the valve can be read.

With the 2 temp. sensor method only

- cUt = Restart of the evaporator after abnormal operating conditions (cutoff)
- Pda = Pumpdown of the refrigerant (cooling relay ON for 30 sec.)

Battery State of Stepper Motor Module

Stepper Motor Modules of the type EVS are equipped with batteries, which allows to close the valves while power failure. At L55 the current state can be read.

Setpoints

The active day or night setpoints are indicated by the left decimal point switched on.

Time information

The Actual Values Page contains all runtime-/remaining time information, so the times up to the start of a function can be read.

State of inputs/outputs

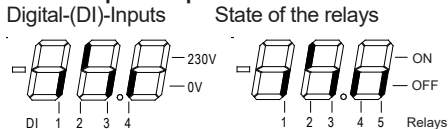

Analogue Output: Parameter L50, value in %

Temperature Sensors

These types of temperature sensors can be used: TF 201, TF 501, So1, So2, TF 202.

The type of sensor can be set by 'h68' (Assignment Page).

Notice If you work with Electronic Expansion Valves we recommend to use the TF 501 sensor.

'Permanent Parameter' - Function

After power-up of the controller, the display will indicate the 'permanent parameter' after some seconds (or in case of a failure it will display the current failure). This can also be read if you don't touch a key for more than 3 minutes. If you think that it is suggestive to show any sensor value as permanent parameter, do the following:

Change permanent parameter

- Select the parameter you want to have as 'permanent parameter'
- Press "↑" and "↓" simultaneously. The display shows "888" for a moment, after that the selected parameter will be shown as the 'permanent parameter'.

Error Messages / Error Memory / Error Codes

If a failure occurs, the controller will show parameter L20 with a shortcut (see below) with a flashing display automatically. If multiple errors are present, they can be called up by the up/down keys. Always the last 15 error messages keep memorized with date and time of their appearance and can also be read-out via data interface.

-no error
- inithe controller has been switched on the first time or had data loss
- hrdhardware failure
- onmains voltage was switched on (not a current but a historic failure)
- oFFmains voltage was switched off (not a current but a historic failure)
- chRsafety chain open
- oPcalarm at digital input X
- dordoor X is open
- rdodoor contact is open too long. This message is only active at a spec. point in time (P42).
- rrtcooling has achieved maximum runtime. This message is only active at a point in time (P42).
- dbtnumber of defrost cycles without termination by temperature exceeded, maybe too many ice or heater malfunction.
- t1btemperature sensor #1 broken, t1c temperatur sensor #1 hot-wired
- t2btemperature sensor #2 broken, t2c temperatur sensor #2 hot-wired
- t3btemperature sensor #3 broken, t3c temperatur sensor #3 hot-wired
- t4btemperature sensor #4 broken, t4c temperatur sensor #4 hot-wired
- t5btemperature sensor #5 broken, t5c temperatur sensor #5 hot-wired
- t6bAnalog IN 0-10V broken, t6c Analog IN 0-10V hot-wired
- tHialarm sensor, overtemperature, tLo alarm sensor, undertemperature
- SElerror in assignment page, e.g. function selected too often
- Ho5communication failure with Master
- Slxcommunication failure with Slave x
- SEecommunication failure EVS-Slave Module
- bRtBattery Failure at the EVS-Slave Module, batteries must be changed
- bR_EVS-Module: The Stepper Valve could not be closed while the last power failure.
- Rdrnetwork address assigned more than once.

If a sensor is short or broken, a time delay of 5 seconds takes effect before an alarm will be activated.

Configuration Concept

The inputs/outputs of the EVP-cold storage controller have no fixed tasks. The EVP works with a "free configurable" concept, this means that all available inputs and outputs (relays, sensors, digital inputs, analogue output) can be configured to work with any integrated control function or control circuit.



Relay output #5 is a Solid State Relay with a lower contact rating than the standard relay outputs. Normally, this output is used for driving Electronic Expansion Valves, but can also be used for any other task if it works within the specified current range.

Sensors

Each sensor can fulfill each function, even up to 3 functions at the same time. (Function (a) of sensor X, Function (b) of sensor X, Function (c) of sensor X, X = sensor#). e.g.:

1. Control sensor /alarm sensor at the same time
2. Defrost limitation sensor and control sensor at the same time, e.g. to control a refrigerated shelf by the temperature of its air outlet.

Parameter

Parameters of functions which are not assigned will not appear in the parameter pages to improve survey.

Assignment

The function of each input and output can be preset on the 'assignment page'. The assignment can be done by keys or via interface.

Configuration Example for an EEx-Valve

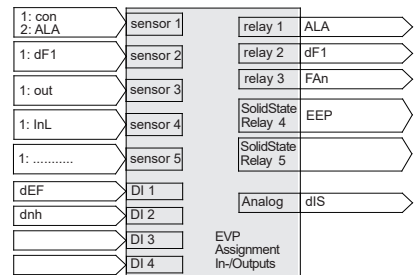

Configuration of the controller



Hereby we use the example from above: A cold storage with an evaporator with Electronic Expansion Valve.

Action	Key	Display	Remarks
enter page listing	"P"	(A)	hold key for > 2 seconds
select assignment page	"↑↓"	(h)	
enter assignment page	"P"	h01	h01 is the 1st parameter on the page and determines the function of relay 1
displaying the function of relay 1	"P"	any	
new assignment of relay 1	"P"	C00	(Code expected) only if no key key is hit for about 3 minutes
enter access code	"↑"	C88	
confirm	"P"	any	
select function	"↑↓"	ALA	ALA = alarm relay
confirm	"P"	h01	parameter # will be displayed again
select new in-/output	"↓"	h02	determines the function of relay 2
displaying the function of relay 2	"P"	any	
new assignment of relay 2	"P"	any	
select function	"↑↓"	dF1	dF 1= defrost relay (evaporator 1)
confirm	"P"	h02	parameter # will be displayed again

Repeat this steps until all inputs and outputs are assigned to the desired functions.

Parameter Pages

Actual Values Page [L]

Param.	Disp	Note	Range	Factory Setting
L01	X	Actual temperature at sensor 1 (can be corrected +/- 10K, Assignment Page)	± 100°C	---
L05	X	Actual temperature at sensor 5	± 100°C	---
L06	X	Actual temp. calculated from pressure+refrigerant	± 100°C	---
L07	X	Actual value of the pressure transducer	[bar]	---
L08	X	Virtual temperature value, calculated from real values and selected emphasis	± 100°C	---
L09	X	Actual superheat temperature	± 100K	---
L10	X	Actual effective setpoint	---	---
L11	X	Actual effective hysteresis	---	---
L12	X	Defrost State..... 0= Standby, 1= Pumpdown, 2= Pause bef. defrost., 3= Defrost, 4= Pause after def., 5= fan start delay, 6= Defrost lock	0..6	---
L13	X	Defrost State of the Slave Modules..... 0= no slave in def., 1= min. 1 slave in defrost	0, 1	---
L14	X	Addresses of the Slave Modules	---	---
L16	X	Actual superheat setpoint	0..100 K	---
L17	X	Active superheat minimum value	0..50 K	---
L18	X	Active superheat maximum value	0..100 K	---
L19	X	Active superheat setpoint set	1 = setpoint set 1 2 = setpoint set 2	---
L20	X	Actual Failure	---	---
L21	X	Runtime of cooling	24.0 h:(10min) max.	00:00
L22	X	Runtime of open door	24.0 h:(10min) max.	00:00
L31	X	Remaining time of open door	240 minutes max.	---
L32	X	Remaining time of temperature alarm delay	120 minutes max.	---
L33	X	Remaining defrost time	minutes	---
L34	X	Remaining defrost idle time	minutes	---
L35	X	Remaining fan start delay time	minutes	---
L36	X	Remaining compressor idle time	minutes	---
L37	X	Remaining fan delay time	minutes	---
L38	X	Remaining release time of the safety chain	seconds	---
L39	X	Remaining time of alarm time extension after defrost	minutes	---
L40	X	Numbers of defrosts with time limit	---	---
L41	X	Solenoid Valve	0, 1, oFF	---
L43	X	Day/Night Operation	on, oFF	---
L44	X	Operation state of the controller unit	on, oFF	---
L45	X	Actual pulse-width (duty cycle) of the frame heater	in %	---
L50	X	Actual Value of the analogue output in X% of the selected range	0-100%	---
L52	X	State of the EEx-Valve, opening degree in % or state : cut (cutoff), Pda (pumpdown)	cut, Pda	---
L53	X	State of the Stepper Motor Valve, opening degree in %	%	---
L55	X	Battery state of the EVS-Stepper Motor Slave Module	0= failure, 1= OK	---
L60	X	States of the digital inputs DI 1...DI 4		---
L61	X	States of the relays 1-5		---

Mode Page [P]

Param.	Disp.	Note	Range	Factory Setting
P01		Assigned to compressor compound # (0 = not assigned)	0, 1, 2, 3	1
P03		Cooling/Fan relay mode (! note correct relay wiring)	nor = normal, in = inverted	nor
P04		Emergency mode if sensor fails in % of the max. power	0..100%	50%
P21		Night operation ON at (in 10 min-steps)	00.0..23.5, oFF	oFF
P22		Night operation OFF at (in 10 min-steps)	00.0..23.5, oFF	oFF
P31		Calibration of sensor 1	+/-10.0, adjustable	0.0
P32		Calibration of sensor 2	+/-10.0, adjustable	0.0
P33		Calibration of sensor 3	+/-10.0, adjustable	0.0
P34		Calibration of sensor 4	+/-10.0, adjustable	0.0
P35		Calibration of sensor 5	+/-10.0, adjustable	0.0
P36		Calibr. temp. value calculated by pressure/refrigerant	+/-10.0, adjustable	0.0 K
P42		Runtime message at (time)	0..23 o'clock, oFF	6 o'clock
P51		Analogue output delivers 0V resp. 4mA if control sensor temp. =	-/+ 100°C	-100°C
P52		Analogue output delivers 10V resp. 20mA if contr. sens. temp. =	-/+ 100°C	+100°C
P60		Cool down start	on, off	off
P61		Cool down interval 1 (step time of the cooling curve)	0 = off, 1..24h	12h
P62		Cool down step 1 (temperature change per step time)	0.5..5.0 K	1.5 K
P63		Cool down pause	0..168h	72h
P64		Cool down threshold	-50.0..+50.0°C	0°C
P65		Cool down interval 2 (step time of the cooling curve)	0 = off, 1..24h	12h
P66		Cool down step 2 (temperature change per step time)	0.5..5.0 K	1.5 K
P70		Standard of summer/winter switch	oFF = off, EÜ = on, tün = on	EÜ
P71		Time Zone Offset	-720..720 Min.	60 min.
P72		SummerON Month	(only for tün) 1..12	3
P73		SummerON Day	(only for tün) 0(Sund.)..6	0
P74		SummerON x-Day	(only for tün) 0..5(last), 0 = off	5
P75		SummerON Hour	(only for tün) 0..23	2
P76		SummerOFF Month	(only for tün) 1..12	10
P77		SummerOFF Day	(only for tün) 0(Sund.)..6	0
P78		SummerOFF x-Day	(only for tün) 0..5(last), 0 = off	5
P79		SummerOFF Hour	(only for tün) 0..23	3
P80, P81		Year, Month		
P82, P83		Day, Hour		
P84, P85		Minute, Second		
P86		Software version of the EVS module		
P87		Software version of the EVP module		
P88		Master or Slave Mode	H50, H51, H52, H53, H54, H55, 5L1, 5L2, 5L3, 5L4, 5L5	H50
P89		Data transmission speed (Baudrate)	12(00)..115(00)	96(00)
P90		Address of the controller unit in a network	0 - 78	78

Defrost Page [d]

Param.	Disp.	Note	Range	Factory Setting
d01		Fan during defrost	on, off	off
d02		Defrost Mode	Ext = external only, Int = extern+intern, AdR = adaptive	int
d03		Fan operation before defrost	0...15 minutes	3 minutes
d04	X	Time up to defrost (in 10-minutes steps)	168...0 h/min	00.0
d05		Maximum time up to defrost (10-minutes steps)	02.0...168.0 h/min	24.0 h
d11		Defrost release time 1 (in 10-minutes steps)	00.0 - 23.5, off	05.0
d12		Defrost release time 2 (in 10-minutes steps)	00.0 - 23.5, off	off
d13		Defrost release time 3 (in 10-minutes steps)	00.0 - 23.5, off	off
d14		Defrost release time 4 (in 10-minutes steps)	00.0 - 23.5, off	off
d15		Defrost release time 5 (in 10-minutes steps)	00.0 - 23.5, off	off
d16		Defrost release time 6 (in 10-minutes steps)	00.0 - 23.5, off	off
d17		Defrost release time 7 (in 10-minutes steps)	00.0 - 23.5, off	off
d18		Defrost release time 8 (in 10-minutes steps)	00.0 - 23.5, off	off
d30		Minimum Defrost Time	0...30 min	0 min
d31		Defrost limitation temperature	0.0°C...100°C	14.0°C
d32		Max. defrost runtime (defrost safety time)	0...240 minutes	45 min.
d33		Alarm time extension after defrost	0...60 minutes	30 min.
d34		Pulse-defrost threshold	-5.0...+100°C	100°C
d35		Cooling pause after defrost (drain time)	0...30 minutes	0 min.
d36	X	Duration of last defrost	minutes	
d37		Number of defrost cycles limited by time, then alarm	off, 1-15	off
d38		Break before defrost	0...15 minutes	0 min
d50		Manual defrost initialization	on, off	

Setpoint Page [r]

Param.	Note	Range	Factory Setting
r01	Setpoint Layer	1, 2	1
r02	Setpoint 1 (day)	-99.9/+100°C	-20°C
r03	Setpoint 2 (night)	-99.9/+100°C	-20°C
r04	Setpoint 1 (day), Setpoint Layer 2	-99.9/+100°C	-20°C
r05	Setpoint 2 (night), Setpoint Layer 2	-99.9/+100°C	-20°C
r10	Hysteresis	0.1...20K	2.0 K
r14	Fan Mode PER = Permanent, Int = Interval, Add = Spec. mode positive room temp.+ latency heat utilization	PER, Int, Add	Int
r15	Fan limitation value	-99.9/+100°C	100°C
r16	Hysteresis of the fan limitation value	0.1...20K	2.0K
r22	Fan start delay	0 bis 30 (min.)	5 min.
r23	Fan trailing delay	0 bis 30 (min.)	0 min.
r31	Runtime check cooling (in 10 minute steps)	off, 00.0...23.5	off
r32	Runtime check door (in 10 minute steps)	off, 00.0...23.5	off
r33	Minimum compressor idle time	0...30 min.	0 min.
r34	Cooling delay after mains voltage loss	0...30 min.	0 min.
r35	Frame heater, period time	10...60 minutes	15 min.
r36	Frame heater, pulse width (ON time) while day mode	0...100%	100%
r37	Frame heater, pulse width (ON time) while night mode	0...100%	100%
r40	Under temperature alarm	on, off	on
r41	Alarm offset (relative to the setpoint)	0...100K	7 K
r42	Alarm offset, Layer 2 (relative to the setpoint)	0...100K	7 K
r43	Lower Alarm Limit (absolute value, threshold for low temperature limitation/alarm)	-99.9/+100°C	-50°C
r44	Lower Alarm Limit, Layer 2 (absolute value), ditto	-99.9/+100°C	-50°C
r45	Temperature Alarm Delay	0...120 min.	45 min.
r46	Release time of safety chain	0...60 sec.	60 sec.
r51	PID proportional band/range	0.1...30.0	4.0
r52	PID integration time	off, 1...600 sec.	10 sec.
r53	PID attack time	off, 1...10 sec.	off
r54	PID delay	off, 0.1...10.0 sec.	off
r56	PID Actuating Variable Delay of Analogue Output / output delay	0...240 sec.	0 sec.
r57	PID Actuating Variable Delay of Analogue Output / step size	1...100%	100%
r58	Cooling/Heating Relay Time Period	1...240 sec.	1 sec.
r59	Cooling/Heating Relay ON-Time	1...240 sec.	240 sec.
r61	Digital inputs alarm delay	0...120 min.	5 min.
r62	Digital inputs door contact delay	1...240 min.	5 min.
r63	Digital input analog value: Voltage/current at the analog outp. with active digital input	0.0...100.0 %	0%
r71	Superheat (dep. on evaporator) minimum value	0.0...50.0 K	8.0 K
r72	MOP (Limitation of the evaporation temperature, depending on compressor resp. plant)	-99.9...+100.0°C	+100.0°C
r73	P-Part of the Expansion Valve (EExV)-Control	0.1...20.0 K	8.0 K
r74	I-Part of the Expansion Valve (EExV)-Control	1...999 sec.	240 sec
r75	Superheat Maximum Value	2.0...100.0K	8.0K
r76	Limitation of the Expansion Valve Signal	0...100%	100%
r77	Actuating Variable Delay of the EEx-Valve / Output Delay	0...240 sec	0
r78	Actuating Variable Delay of the EEx-Valve / Step Size	1...100%	100%
r79	Superheat minimum value setpoint set 2	0.0...50.0 K	8.0 K
r80	Superheat maximum value setpoint set 2	0.0...100.0 K	8.0 K

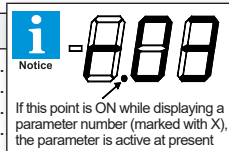

Real Time Clock

The built-in real time clock has a buffer for max. 10 days without mains voltage. Date and time can be set by "P80"... "P85" (Mode Page). By default, a GMT +01:00 is set ("Time Zone Offset" = 60 min.), which is standard for the Central European Space. If the product is used in other countries, this value can be changed.

Summer/Winter Switch - Time Zones

An automatic summer/winter switch "P70 = EU" (Mode Page) considers the current EU-rules from 1996 (EU 96), but can also be switched off or set as needed.

Variable Time Zones

The function for Variable Time Zones can be activated by "P70 = tun" and is adaptable by the parameters "P72"... "P79".

- P72 (SummerON Month)(Fact.Setting March, 3rd) The month of the beginning of the summertime
P73 (SummerON Day) ...(Fact.Setting. 0, sunday) The weekday of the beginning of the summert.
P74 (SummerON x-Day) ...(Fact.S. 5, last sunday) The x-th with "SummerON Day" preset day of .. the month

- P75 (SummerON Hour) (Fact.Set. 2, 2 o'clock) The hour of the beginning of the summertime
P76 (SummerOFF Month)(Fact.Set. October, 10th.) The month of the end of the summertime
P77 (SummerOFF Day) ...(Fact.Setting 0, sunday) The weekday of the end of the summertime
P78 (SummerOFF x-Day) ..(Fact.S. 5, last sunday) The x-th with "SommerOFF Day" preset day of the month
P79 (SummerOFF Hour) ..(Fact. Set. 3, 3 o'clock) The hour of the end of the summertime
The shift to the summer resp. winter time is set by the time setting which is active at this time.

Assignment Page [h]

Table with 4 columns: Param., Disp, Note, Range, Factory Setting. Contains detailed parameter assignments for relays, sensors, and digital inputs.

Parameters marked by "Disp" are for information only and cannot be changed.

Dimensions & Wiring

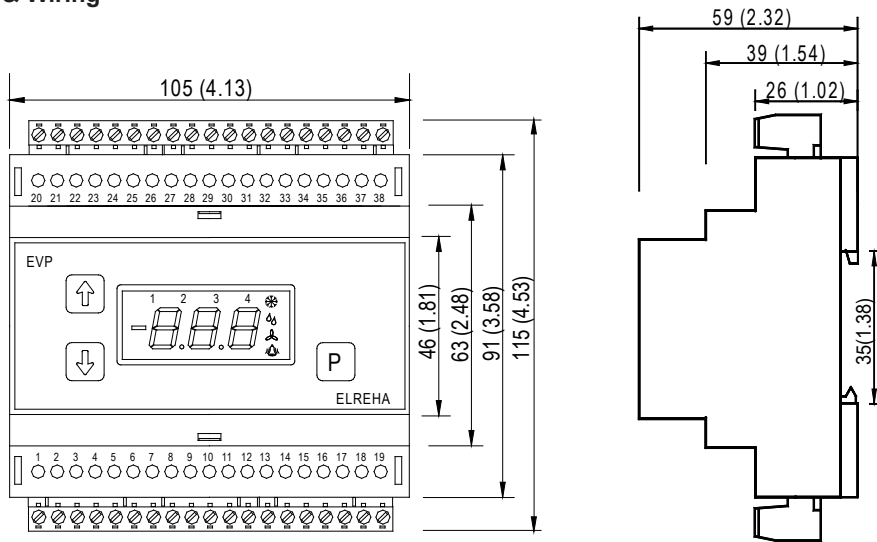

Note Protective Earth
 Earth
 Dimensions in mm,
 (in brackets = inches)

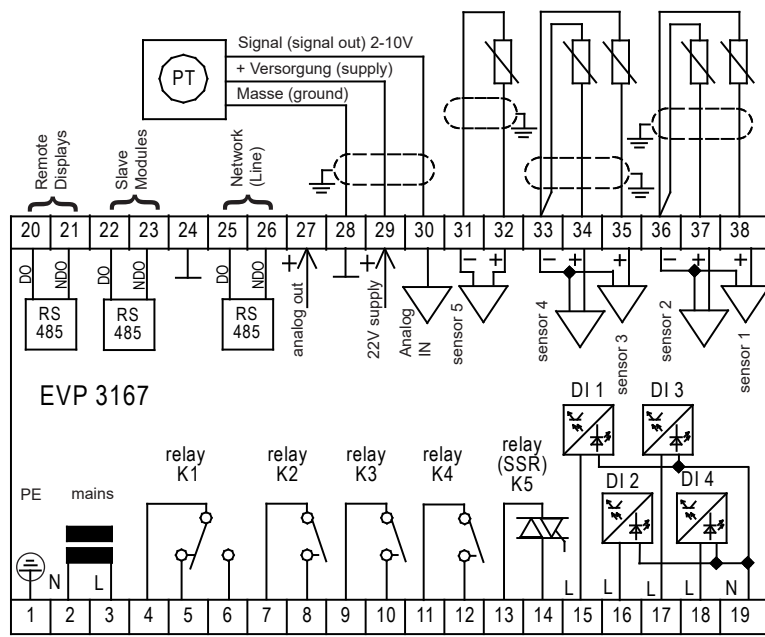

! When connecting the switch outputs, the overvoltage category must be respected !

! * With connecting an inductive load to the SSR output, like e.g. a relay, it may be necessary to connect a snubber circuit in parallel to the load to protect the output from an uncontrolled turn on. By an uncontrolled turn on it is possible that the load is switched on permanently. The snubber circuit must be adapted to the load.

Connection of a Pressure Transducer to several controllers

This controllers work with different cooling positions and are not connected as master/slave

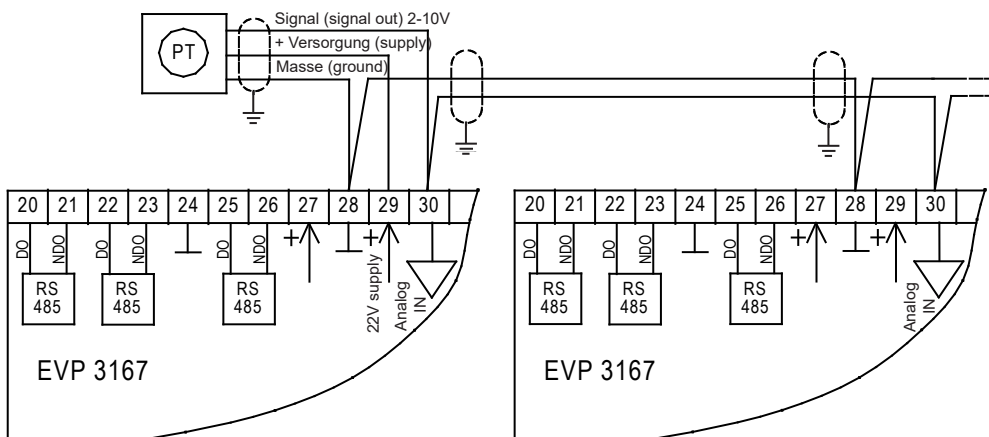

EC Declaration of Conformity



For the device **EVP 3167** we state the following: When operated in accordance with the technical manual, the criteria have been met that are outlined in the EMC Directive **2014/30/EC** and the Low Voltage Directive **2014/35/EC**.

This declaration is valid for those products covered by the technical manual which itself is part of the declaration.

Following standards were consulted for the conformity testing to meet the requirements of EMC and Low Voltage Guidelines:

EN 55011:2016+A1:2017, EN 61010-1:2010, EN 61326-1:2013

CE marking of year: 2018

This statement is made for the manufacturer / importer

**ELREHA Elektronische Regelungen GmbH
D-68766 Hockenheim**

www.elreha.de

(Name / Address)

by:

Werner Roemer, Technical Director

Hockenheim.....2018-06-22.....

City

Date

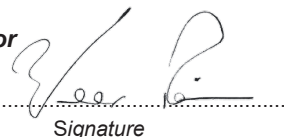
Signature

'Physical' and 'virtual' sensors

1. Each 'physical' (real) sensor is able to fulfill up to 3 functions at the same time (see Assignment Page), any sensor is able to do the same job.

Up to 4 control sensors can be assigned the same time. If *one of them* gets warmer than setpoint + hysteresis, then cooling starts.

2. It is possible to create a 'virtual' sensor to realize different kinds of averaging, e.g. multiple sensors in a huge room or averaging of inlet and outlet sensor in a chest freezer. The 'virtual' sensor resp. value (L08) follows from the selectable emphasis of the sensors which must have an effect on the result (h17, h27, h37, h47, h57, Assignment Page).

The functions assigned to this 'sensors' (h61, h62, h63, Assignment Page) are the same as the functions for the 'physical' sensors.

Example: If the 'physical' sensor 1 got the function "con" (control sensor) and also the 'virtual' sensor, then the warmer one initiates refrigeration.

- Selection of a "virtual sensor":
 - Assignment of a function by **h61-h63**
- Selection of a 'physical' sensor which must have an effect on the result :
 - Activating of the sensor by assigning a function (e.g. display only sensor)
- Set emphasis for the selected sensor (h17, h27, h37, h47, h57).

i The sum of all emphasis values must be 100%. *Example:* If sensor 1 and sensor 2 must have an effect on the result and you set "h17" to "30%" and "h27" to "60%", then you get the error message "SEL" (assignment error).

Further causes for the error message "SEL"

- The sum of all emphasis parameters is 100%, but no virtual sensor function is selected
- All 4 emphasis values are set to '0' and a 'virtual' sensor function is assigned
- A physical sensor is switched off, but an emphasis value > 0 is selected.

Example 1. Chest Freezer:

For the detection of the actual value, inlet and outlet sensor must be used. Sensor 1 is mounted at the suction side (inlet) and must have an 60% influence on the result. Sensor 2 is mounted at the outlet and must have an 40% influence.

- set "h17" to "60"
- set "h27" to "40"
- set "h61" to "con" (control sensor)

Example 2. huge room. standard application

Sensors 1-3 must measure the rooms temperature, an arithmetic average must be calculated, sensor 4 is the defrost limitation sensor in the evaporator.

- set "h17", "h27" to "33" and "h37" to "34"
- set "h61" to "con" (control sensor)
- set "h41" to "df1"

i **Special Function**

If an emphasis parameter value is set to 100% (others to 0), up to 6 functions can be assigned to the corresponding physical sensor. This may be of interest for applications where more than 3 sensor functions are used.

Cooling

Cooling control by Solenoid Valve / Compressor

Cooling is controlled by switching the output relay contacts ON an OFF.

For freezing applications, the N/C contact can be used (inverted mode) to secure permanent cooling in case of a controller defect, adjustable by "P03" (Mode Page).

The point of cut-off is always the valid setpoint. If the temperature at the control sensor exceeds setpoint + hysteresis ("r10", Setpoint Page), the control relay will switch on. "P03" also affects to the switching characteristic of the fan relay.

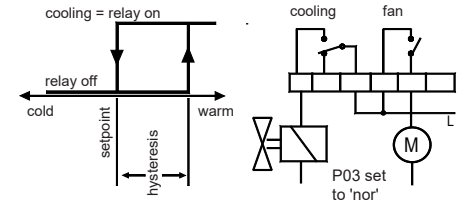

! Do not use 'inverted', if compressors are controlled directly. Risk of compressor damage by continuous running! The control relay can be locked via data interface.

Low temperature Limitation

Can be used e.g. for refrigerated shelves with roller blinds to limit the temperature at the air outlet during night operation. When the temperature at the alarm sensor decreases the limit set by "r43" (resp. "r44", Setpoint Page) cooling will switch off.

This value is the threshold for the low temperature alarm at the same time.

i The low temperature limitation cannot be switched off, it can be disabled only in the way that the parameter is set to the lowest value. The alarm mode itself can be switched off at parameter r40.

Cooling compulsion/-release

The cooling function can be locked or released by a configured digital input (rLL, rLH, rFL, rFH, Assignment Page).

If no control sensor is available, cooling can also be triggered by force via this digital input.

Heating function

One relay is able to work as a heat relay. Then the control setpoint is the cut-off of heating and cooling at the same time. Cut-in will be:

- for cooling: setpoint + hysteresis (r10)
- for heating: setpoint - hysteresis (r10).

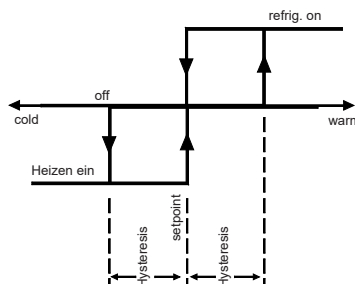

Temperature Alarm

If a relay gets the function "ALA", a temperature alarm will be forwarded by the 'Quiescent current' principle. After power-up of the controller, the alarm relay will be energized after ~12 sec. In case of a failure the relay will be de-energized after a delay timer ("r45", Setpoint Page) has been run down. LED "Alarm" shows the alarm state. If temperature comes back to the normal range, the relay will be energized again. "L32" shows the remaining time up to an alarm.

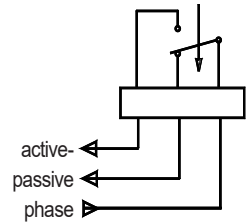

Overtemperature Alarm

It is possible to select max. 5 (6 with the 'virtual') alarm sensors (e.g. 5x "ALA"). If the temperature at one of the alarm sensors exceeds the control setpoint + the "r41" (resp. "r42", Setpoint Page) setting, an alarm will be initiated after the delay time "r45". The alarm will be reset if the temperature falls below 'control setpoint + alarm offset - 1K'.

Under temperature Alarm

If the temperature at any alarm sensor gets lower than the "r43" (resp. "r44", Setpoint Page) setting, an alarm will come on with the delay explained above. This setting is an absolute value and does not refer to the control setpoint. At the same time, this setting works as threshold for the "low temperature limitation" function. The alarm will be reset if the temperature exceeds 'lower alarm limit + 1K'.

i Under temperature alarm can be disabled by "P41" (Mode Page)

Supplementary alarm delay during defrost

After a defrost cycle the temperature may take longer to stabilize and the normal alarm delay turns out to be too short. For this reason the value of parameter „d33" (defrost page) will be added on to the normal alarm delay after defrosting.

Runtime Monitoring

The controller monitors the total running hours of the cooling output over 3 days. A 'day' is defined as the period within "P42" and 1 minute before the same point in time next day.

Example:

"P42" set to 11:00 am = Monitoring time range is from 11:00 o'clock day 1 up to 10:59 o'clock day 2.

The overall runtime of the cooling relay over a day will be added and stored ("L21", Actual Values Page). If this runtime exceeds the value set by "r31" three days in a sequence, this will cause an alarm at the hour programmed by "P42" (Mode Page). The alarm relay will be de-activated and the alarm LED switches on.

This alarm will be cancelled automatically 1 hour later.

Operation with a single compressor

If a single compressor is controlled by a refrigeration relay, it is suggestive to have an idle time (r33, Setpoint Page) to prevent the machine from damages caused by short cycle operation. The compressor can restart only after the timer "r34" (Setpoint Page) has been run down. The remaining time up a restart can be read at "L36" (Actual Values Page).

Second setpoint (night operation)

A second setpoint can be defined by "r03" (Setpoint Page). This can be used for night operation or other energy savings. Switching between these setpoints can be made by internal clock or by digital input. The current used setpoint is marked by a lighted decimal point in the parameter display. On the 'Actual Values Page', parameter "L43" shows the current state.

Internal switching

The parameters „P21“ and „P22“ determine the 2nd setpoint period. If the internal timer is not used, set both times to "oFF".

External switching

The digital inputs can be configured for external switching, selectable as "dnL" (active low) or "dnh" (active high). After the input has been activated, the 2nd setpoint is active all time and the internal timer is disabled. If you want to use external switching only, please set „P21“ and „P22“ to "oFF".

Second Set of Setpoints

The controller offers two complete setpoint sets including day/night setpoints and alarm limits.

Example Application:

By an external switch it is possible to change a cold room from refrigeration to freezing for temporary storage of other products, without changing any parameters at the controller. Even here the currently used setpoint is marked by a lighted decimal point in the parameter display.

Toggleing between the setpoint layers

1. internal: by parameter „r01“ (Setpoint Page)
2. external: assign function „SEt“ to a digital input. If connected to mains phase, the 2nd layer is in use.

Light Control

One of the relays is able to control room lightings (function "Lit"). In this case, the relay switches together with the night settings.

While 'day'-operation the light relay keeps energized. Light control is also possible with an digital input (see 'Door Contact Input').

Emergency Operation

If all control sensors fail, the unit turns to an emergency mode automatically. The cooling relay cycles with a %-part (P04, Mode Page) of a 30 minutes period.

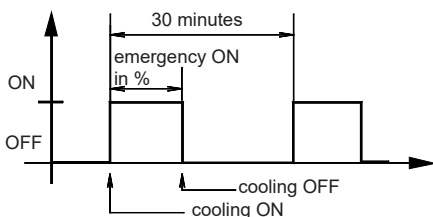

Time Controlled Cooling (Cooling Curve)

In order to meet the structural requirements for commissioning of refrigeration facilities, with this function the cooling down of the cold storage can be delayed automatically by a 3-phase time control. This 'Cooling Curve' must be started manually by parameter 'P60'. The cooling starts at the actual value of the control sensor at the cold storage, reduced by a cool down step.

- **Phase 1**
Parameter 'P61' determines a cooling interval for the first cooling phase. After each cooling interval, the setpoint will be put down by the value set with 'P62'.
- **Phase 2**
With 'P63' a break of the cooling can be initiated. While this time, the temperature will be hold on the value set by 'P64'. After the end of this cooling pause the next cooling phase starts.
- **Phase 3**
Parameter 'P65' determines the cooling interval for the second cooling phase. After each interval, the setpoint will be put down by the value set with 'P66'.

"L10" on the Actual Values Page then always shows the currently active cooling setpoint.

The function will be de-activated if the active cooldown setpoint or the actual value of the control sensor reaches or falls below the cooling setpoint.

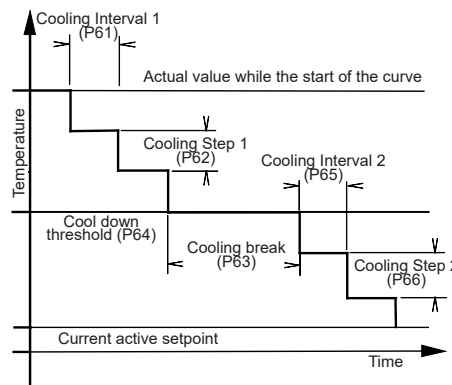

Behaviour while possible failures:
The Cooling Curve will be restarted automatically with the measured actual value if:

- a sensor failure has been occurred and is now fixed
- the controller has been restarted e.g. after a mains loss.

Then the actual cooldown setpoint will be configured in the same way as at a manual start of the function, lowered by a cooling step.

Digital Inputs (Optocoupler Inputs)

Switching OFF the controller unit
Sometimes it is necessary to switch off cold storages completely including the controller. If the controller works in a network, the bus-master so detects a malfunction and generates an alarm. To prevent this, the unit must be switched OFF via digital input.

Cooling compulsion/-release
The cooling function can be locked or released by a configured digital input. If an input is configured with the functions 'rLL' or 'rLH' and no control sensor is available, cooling can only be switched by this digital input. If a digital input is configured with 'rFL' or 'rFH' and a control sensor is available, then the digital input releases the cooling function only and it will be controlled depending on the sensor values.

Controller OFF
If a digital input is assigned to the functions "oFL" or "oFH" and is activated by the matching signal, then all control functions will be disabled. All alarm functions are locked and the display shows "oFF".

Safety Chain Monitoring
When using the controller for single compressor applications, one of the digital inputs can be used to monitor the safety chain ("chA"). Normally the digital input is connected to phase via this chain of contacts. If the chain opens, cooling and fan will switch off, a running defrost cycle will be terminated and a new defrost cycle is impossible. Parameter "r46" defines the response time on the missing signal voltage.

Door Contact Input
Each control circuit can get a door contact input. Each digital input can be configured with "doL" (passive = 0V) or "doH" (active = voltage). If a digital input will be initiated, the evap fan stops immediately. The control range of the EE-x-Valve will be changed automatically to avoid a further evaporation. If the door is open > 3 minutes, cooling will be stopped. All other functions will continue working. If the door is open for a longer time set with 'r62' (Setpoint Page), the unit generates the error message "dor", cooling restarts and an alarm message will be forwarded.

Exception:
If no alarm sensor is assigned or if the temperature is above the alarm limit, cooling continues without interruption.

Light control by door contact
Any relay can be assigned with the function "dor". If a door contact input is activated, this relay switches on immediately, to switch on e.g. the lighting in a cold storage room.

Door open monitoring
Every time a door is opened, the controller adds the time to the total opening time of the present day "L22" (Actual Values Page). If the total opening time exceeds the value set by "r32" (Setpoint Page), an alarm will be generated. The alarm message will be forwarded at the point in time determined by "P42" (Mode Page) and will be cancelled automatically 1 hour later. "L31" shows the remaining time up to the alarm message.

External Alarm
The digital inputs are able to process external alarm messages. For this, the function "ALA" must be assigned (Assignment Page). While normal operation, the input is connected to mains phase. When the voltage drops down, a delay time starts ("r61", Setpoint Page). After this timer has been run down, an alarm will be forwarded.

Temperature control with Electronic Expansion Valves

The EVP 3167 is able to control one (1) cold storage with an evaporator equipped with an Electronic Expansion Valve (EExV). **In such applications, the EExV takes over the jobs of the former solenoid valve and the compulsive thermal expansion valve.**

Expansion Valves

This types can be used:

1. Pulse-width modulated, cycling expansion valves
2. Valves with thermal drive
3. Stepper Motor Valves (with slave modules EVS only)

Standard EEx-Valves

AC valves can be used which are supplied by mains voltage via an SSR-relay. Mismatches valve/nozzle and evaporator will be compensated in a wide range. Because the valves need no high pressure difference to open, it's possible to work with low condensation pressures, as long as the configuration allows that.

From this it follows a higher COP-value for the compressor and so an option for energy saving. The energy saving depends on outdoor temperature (if the condenser is located on the roof) and is higher in winter than in summer.

By the optimal filling of the evaporator and the more equable icing an additional energy saving of 2 - 5% is possible.

Stepper Motor Valves

The EVP is able to control the superheat by Stepper Motor driven valves. The valves are driven by an EVS slave module, which contains additionally a battery and safety functions, which enables to close the valve any time.

The EVS slave module is connected via the data interface 'slave module'. With the parameter "h80", the type of the connected valve can be configured.

Electronic Expansion Valve and Single Compressor Plants

For Single Compressor Plants we recommend to use the pressure/temperature method. The compressor can be controlled by an external suction pressure switch or the refrigeration relay of the controller.

Variable Superheat Control / 2nd Setpoint Set

If you get a difference by the settings of r71/r79 (Superheat, minimum value) und r75/r80 (Superheat, maximum value), then the superheat will be shifted by the control algorithm within the ON-point (setpoint+hysteresis r10) and the OFF-point (setpoint). If the function is disabled, the superheat value is determined by r71/r79 only.

Function is enabled:

r75/r80 (Superheat, max. val.) exceeds r71/r79.

Function disabled:

r75/r80 is below or equal to r71/r79.

The setpoints for minimum superheat r71 and maximum superheat r75 can be switched to a second set of setpoints r79 and r80. The second setpoint set may be activated by a digital input signal or by network from a VPR system. Parameters L17, L18 and L19 show the active values.

Limitation of the EEx-Valve Signal

With this function (r76) the maximum opening of oversized expansion valves can be limited. It affects on all possible expansion valve output signals:

- Analogue output assigned to an EEx-Valve
- Expansion valve relay

Actuating Variable Delay for EEx-Valves

r78 (step size) and r77 (output delay) affect as actuating variable delay for the Electronic Expansion Valve, both for the analogue output as well as the relay output. The OFF-values (0 resp. 100%) will be initiated immediately with: Controller OFF, Solenoid Valve Lock, Safety Chain Failure, Refrigeration OFF because of an open door, defrost initiation.

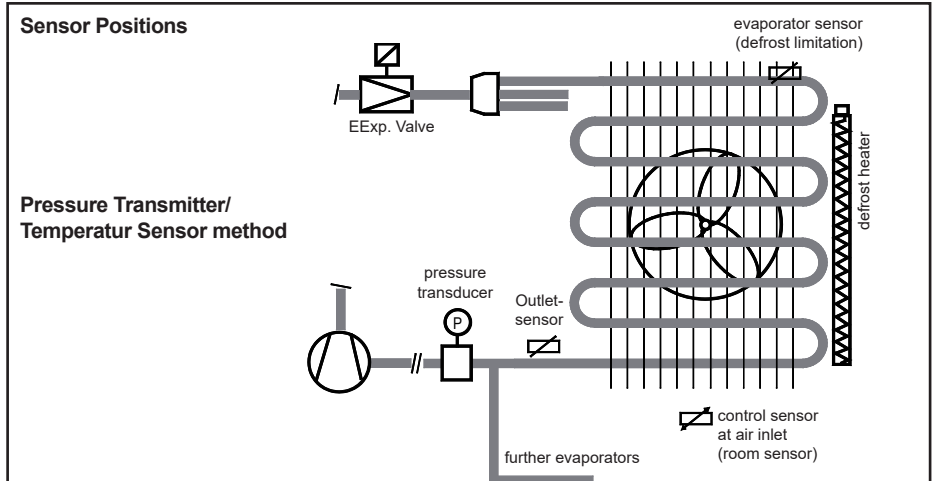

Measuring Methods

The EVP is able to work with 2 measuring methods:

1. Pressure Transmitter and Temperature Sensor at the evaporator outlet, this is equivalent to the arrangement of a thermal expansion valve.
2. 2 Temperature Sensors at the inlet and the outlet of the evaporator.

i The unit always controls the 'virtual' aperture size of the valve to reach an optimal filling and so the optimal efficiency ratio of the evaporator. Period time and pulse-width of the PWM-control are defined by the control algorithm (autoadaptive), disturbances like suction pressure fluctuations and flashgas will be filtered out.

1. Pressure / Temperature method

To capture the superheat, a pressure transmitter with 2-10V output signal and a TF 501 temperature sensor at the evaporators outlet is used. The arrangement of this parts is equivalent to the components of a thermal expansion valve.

i This method is strongly recommended for single machines or plants with just a few evaporators. The compressor can be controlled by an external suction pressure switch or the cooling relay of the EVP. By this, special operating modes and an automatic "pumpdown" function are possible.

Parameterization

The following recommendations refer to the pressure transmitter "DG -1/9 2-10V".

- L06 Display of the temperature which is calculated from pressure value and refrigerant
- L09 Actual Superheat Value
- h99 Method is active as soon as the used refrigerant is selected.
- h97 Lower limit of transmitter (-1.0, relative pressure)
- h98 Upper limit of transmitter (+9.0, relative pressure)
- h95 Lower voltage limit of the pressure transmitter input. (2V. Below this 2V, an error message is generated).
- h96 Upper voltage limit of the pressure transmitter input (10V).

- r71 / r79 ... Superheat setpoint, minimum value (depends on evaporator)
- r72 MOP-setpoint (Maximum Opening Pressure, i.e. limitation of the evaporation temperature at the outlet. Depends on compressor resp. plant).
- r75 / r80 ... Superheat setpoint, maximum value

The settings of r71/r72 depend on the used compressor and the used evaporator.

- r73 P-Part of the Expansion Valve Control
 - r74 I-Part of the Expansion Valve Control
- The factory settings of r73/r74 are almost ideal for all kind of cold storages, changes must be made with care.

After this basic settings, all other relevant parameters must be set.

2. Temperature sensor method

To capture the superheat, 2 temperature sensors (TF 501) are used, one at the inlet and one at the outlet of the evaporator. For this method, no pressure information is necessary.

Parameterization

- h99 Must be set to 0, i.e. no refrigerant selected. Inlet- and outlet sensor must be assigned. No further parameterizing necessary, except standard settings.

Connection of the EVS Slave Module for Stepper Motor Valves

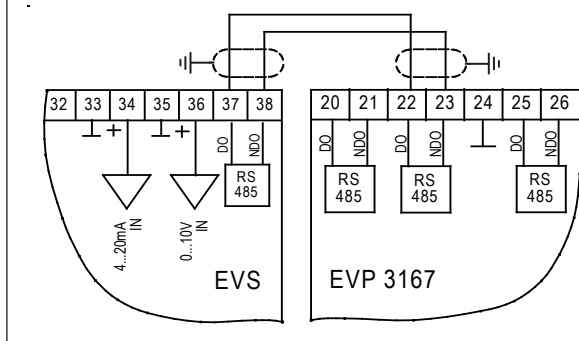

i Parameter "L52" (Actual Values Page) shows the state of the EEx-Valve permanently. The state of the Stepper Motor Valves can be read at "L53".

Because EVS modules contain batteries for an emergency mode, at "L55" the current battery state can be read.

Defrost

The EVP allows several, different defrost methods. Up to 3 defrost relays can be assigned. This relay output(s) then control an electric heater or fan which defrost the evaporator(s).

Each evaporator with electric heater is monitored by a defrost termination sensor.

According to the application, the fan can stop or run during the defrost cycle.

- **"d02"** (Defrost Page) fixes the defrost initiation mode.
 - **"Etn"** : Defrost is initiated by a digital input
 - **"Int"** : Defrost can be initiated by digital input or the internal time-switch.
 - **"AdA"**: Defrost is controlled by the intelligent (adaptive) defrost algorithm

Electric defrost heaters are always switched by the N/O contact of the defrost relay. **"L33"** shows the remaining time up to the end of the defrost cycle.

Defrost release by internal timer

With parameters **"d11"**...**"d18"** (Defrost Page) you can set eight (8) possible defrost release times. This points-in-time can be set in 10 minute steps only, that means a defrost time like 6:55 is impossible. Times on the display:

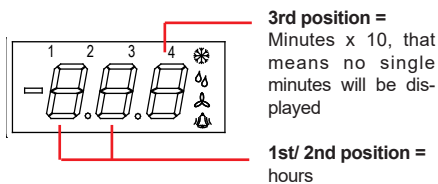

The precondition for the start of a defrost cycle is that at least one of the defrost termination sensors detects a temperature below limitation temperature. If parameter **"d02"** is set to **"Etn"** (external only), a defrost cycle cannot be initiated by the timer.



Please note that this function differs with the 'adaptive' defrost method

External (Remote) Defrost Initiation

To start de-icing by a digital input, note that mains phase has to be applied for 2 seconds minimum and last not longer than the shortest possible defrost cycle.

Break before defrost

Parameter **"d38"** (defrost page) effects a delayed energizing of the heater at the beginning of the defrost cycle. By this, the rest of the evaporators chillness can be blown to the storage.

The defrost heaters must deliver less energy, because the evaporator is already warmed up.

Minimum Defrost Time

For special applications a minimum defrost time makes sense. With parameter **"d30"** a period of time within 0...30 minutes can be defined. If this time is set higher than the safety time, the defrost ends with this time. With this Minimum Defrost Time it will also be ignored if the defrost limitation sensor has been exceeded the set value or there is a error at this position.

Defrost termination by temperature

The EVP controller is able to work with up to 3 defrost relays (= evaporators). Defrost is individually terminated for each defrost output by the corresponding defrost (evaporator) sensor. This evaporator sensor must be placed at a position where, by experience, ice remains the longest time. If the temperature rises at that position, the ice in the evaporator is probably melted completely.

A defrost cycle is completed as soon as all defrost sensors has reached the defrost limitation temperature **"d31"** (Defrost Page).

If multiple defrost sensors are assigned, all sensors must achieve the limitation temperature to terminate defrost.

Defrost termination by time

If no defrost sensors are assigned or if they are out of order, the defrost cycle will be terminated after **"d32"** (Defrost Page) has been run down. **"L33"** shows the remaining time up to termination.

Defrost termination time monitoring

The unit captures the number of defrost cycles which are terminated by time (min. 1 defrost term. sensor must be assigned). If the number of defrost cycles terminated by time exceed the number programmed by **"d37"** (Defrost Page) an alarm message will be generated at the time set by **"P42"**. With this function, massive icing or defective defrost heaters can be recognized timely and reliable.



In case of airflow-defrost without an evaporator sensor, this function must be disabled (**"d37=OFF"**), because here each defrost will be terminated by the safety time **d32** and no alarm message is desired.

Cooling Delay (drain time)

After defrost is terminated, the solenoid valve keeps locked for the time set by **"d35"** (Defrost Page). **"L34"** shows the remaining time up to the restart of cooling.

Manual Defrost

A manual defrost initiation is possible at any time. To start manual defrost:

- Select **"d50"** (Defrost Page), set it to **"on"** and confirm.

Stop manual defrost

- Select **"d50"** (Defrost Page), set it to **"OFF"** and confirm.

Pulsed Defrost

To save energy it's possible to work with a pulsed (switched in intervals) defrost function.

If the evaporator temperature is located within **"d34"** (Defrost Page) and the limitation temperature **"d31"** (the value of **"d34"** must be lower than limitation temperature), the controller determines about the optimal heat distribution in the evaporator depending on the gradients of the temperature. The heater will be switched on in controlled periods until the defrost limitation temperature is reached.

The result of this procedure is:

- Heat energy in the evaporator will be distributed much better
- Defrost limitation temperature can be set to a lower value
- Less of humidity in the chamber
- Save of energy

Defrost in the Master/Slave Mode

If multiple EVP-Controllers are connected to increase the possible defrost positions, then the defrost will be initiated in principle by the 'Master' (The leading controller).

The end of the defrost period is reached individually at the positions which have reached the limitation values. The refrigeration can restart only, if all defrost positions are switched off.

Display Hold Function (DH) while defrost

This function allows to hold ('freeze') the temperature values of any temperature sensor during a defrost cycle.

While defrost, the display shows the last value which was measured before the defrost has been started. After the defrost cycle has been terminated, the display shows this value until

- the current measured value becomes less than the 'frozen' actual value + 2K or
- the display will be reset to the actual value after 15 minutes automatically.

While this period of time the 'frozen' actual value will be displayed as well as transmitted via the data interface. At the same time, the real actual value is only available for internal use and cannot be used external (e.g. for data logging).

This function can be initiated by the sensor function **"Hld"** (Assignment Page) and can be combined with any probe.

If the actual value is still required while this time, the virtual sensor can be used as DH sensor.

If a real probe with an assigned DH function is used for this virtual probe, this function will be ignored and the real actual value will be used for weighting.



Defrost Information

The duration of the last defrost can be read at parameter **d36**.

Intelligent Defrost (adaptive defrost) for Walk-In Coolers

Main Characteristics

This defrost control method fits especially for **cold stores** and **walk-in coolers**.

i It is **less efficient** in applications where the limitation sensor is located in the airflow (e.g. open chest freezers).

This technique **reduces significantly the amount of energy** the refrigeration plant needs.

Especially while **difficult situations** (like high air-humidity, in cool-down chambers, while long opening times of the door of the cold storage room, uneven feeding of the cold storage room, etc.) the adaptive method protects the evaporator from glaciation safely.

Dynamic 'room-feeding' situations engage the controller to adapt itself to the new situation, without expensive adjustment by technical personnel.

Specialized sensors or additional probes are not required.

Parameterization is very easy:

- set parameter "d02" to value "AdA" (adaptive)
- set parameter "d05" (Defrost Page) to a value which is 2 or 3 times the normal defrost interval. Within this period the algorithm decides independently about the point in time to defrost. After the end of this period defrost starts in all cases.
- parameter "d04" (Defrost Page) shows the time up to the next defrost.
- parameters "d34" and "d31" define the range the heater will be pulsed within.

Process Sequence

1. While the time period set by „d05“ the controller decides itself if and at which moment a defrost cycle is necessary. If icing is detected, the controller prepares defrost and begins either immediately or at the next allowed defrost time.
2. Cooling stops, the fan goes on turning a certain time
3. The fan stops and the defrost heater starts
4. If several evaporators are installed, each one has its own defrost sensor and heater relay, so it is individually heated.
5. With working temperatures of [setpoint + hysteresis > 2,5°C] the process saves energy by increased use of the fan (**more airflow**) to reduce icing.
6. After achieving a defined evaporator temperature, the heater will be clocked in calculated periods.
7. Defrost heater cut off, limit temp. is reached.
8. Cooling and fan remain still off (drain time).
9. Restart of cooling, fan start delay / still off.
10. Normal refrigeration starts again.

Refrigeration

Even during normal operation the fan stays on after cut-off of cooling to reduce icing.

Recognition of icing

The more ice on the fins the more increases the difference of temperature between the room sensor and evaporator sensor. The controller uses the value of these sensors, their difference, the historic curves of these values as well as curves and duration of the past defrostings to calculate the necessity of defrosting.

Use of latent energy by airflow

We recommend to use "d03" (defrost forerun, defrost page) to switch on the fan several minutes ahead the defrost cycle, while cooling stops and the heater is not yet on. Additionally, the fan is switched on automatically at a certain difference between the sensors. By this, the „cooling-energy“ is brought out of the evaporator and stored in the chamber. This helps also to reduce the amount of heat energy necessary to defrost.

Defrost start

If all release time parameters are set to Off, the controller decides itself about the start of defrost.

- **Further time influence**
If you want to prevent that defrost starts at certain day-times use all the defrost release times and set them to points in time where defrost is allowed. If no icing is detected, these times will be ignored.
On the other hand, once icing detected, the controller will wait for the next defrost release time before starting a defrost cycle.
- **External command**
Assign one of the digital inputs to "deF". By applying voltage to that input it is possible to start defrosting at every moment.

Defrost Heating

When „d34“ is achieved, the heater will be cut off. The heat energy of the resistances will dissipate slowly and melt the ice. The length of the cut-off is calculated by the controller and as soon as some criteria are fulfilled, it will switch on the heater again. The heater will be pulsed until the temperature of the evaporator sensor reaches the defrost limitation temperature "d31".

This procedure fits in the same way for the case of several evaporators in the chamber. So the heat is able to distribute itself equally

i **By this way defrost period will take longer, but will be more efficient.**

A pulsed Defrost Heating usually takes longer than a conventional, but the defrost energy requirement is significantly lower.

Several evaporators in one chamber

For certain plants it is necessary to use several evaporators in one chamber. The controller is able to control up to 2 evaporators in one chamber. Even in this case one unique room sensor is sufficient. E.g. for a chamber with 2 evaporators you need only 3 sensors:

- one control sensor
- one defrost sensor at each evaporator

If a defrost cycle is necessary, all evaporators will start defrost at the same time to avoid short circuit of air, when one is heating and the fan of another is turning. The one with the highest rate of icing determines the start of the defrost cycle. The EVP controller units are capable to **determine just this evaporator** and even to adapt it when conditions change.

Thus always the evaporator with the most ice initiates defrost start, nevertheless the quantity of energy which is necessary to defrost will be calculated for each evaporator separately.

To finish defrost cycle all evaporators must have reached the defrost limitation temperature.

Emergency Operation Mode

In cases the controller recognizes that it would be incapable or to slow to control the process, or when it gets not enough information, e.g.:

- charge of unusual very humid goods
- freezer door was open a very long time
- the evaporator is sprinkled with water
- sensor broken or shortened

the emergency operation starts.

To detect malfunction of the defrost control the unit uses the increasing of "d05".

If a defrost cycle is terminated by this time, the controller starts several defrost events with the interval corresponding to (1/4) one quarter of the time programmed by "d05".

Therefore be careful in choosing the time for this parameter.

After the end of the disturbance the controller works on normally.

Example

Max time to defrost is set to 24 hours. If defrost is not terminated by the evaporator sensor, the controller will start defrost cycle every 24 / 4 = 6 hours until a cycle will be finished by the evaporator sensor and not by timer. Independent from this procedure, a failure message will be initiated.

End of defrost

When the defrost sensor has reached the defrost limitation temperature "d31", the heater stops and the controller waits until "d35" has expired, to allow the melted water drop to the drainage.

While the following 'drain-on' time ("r22", Setpoint Page) cooling starts, but the fan still stay OFF to prevent that the fans blow warm and humid air or water drops into the chamber.

i **Defrost information**
With using the adaptive method, the time up to the next defrost can be read at d04.

i Further information about possibilities to use latency heat you can find under "Evaporator Fan Control"

Analogue Output

The analogue output can be used for regulation purposes or to provide a remote display with an actual value image. The signal is available as a DC-Voltage or a DC-Current-Signal, fixed by "h67" (Assignment Page). Parameter "L50" (Actual Values Page) shows the current output signal as a %-part of the selected range, "h66" (Assignment Page) determines the behaviour of the output:

Test functions

- "h66" = "- - -" output signal is 0V resp. 4 mA (fixed)
- "h66" = "100" output signal is 10V resp. 20mA (fixed)

Transmission of actual values to remote displays or similar

- "h66" = "dis" This function allows the analogue outputs to deliver a mirror of the actual value of a control probe or the warmest, if multiple probes are configured..
 - P51 = With this actual value the output delivers 0V resp. 4mA
 - P52 = With this actual value the output delivers 10V resp. 20mA

Control with the analog output signal (PID-control)

- "h66" = "P" PID-controller, whose output signal represents an addition of the components P, I, D and T1. In case of a failure the output goes to 0%.
- "h66" = "Pr" PID-controller like above, but with inverted output (rising temperature = falling signal).
- "h66" = "P~" PID-controller, whose output signal represents an addition of the components P, I, D and T1. In case of a failure the output goes to 100%.

To adapt the controller to the process use the following parameters:

- "r51" = PID proportional band, located symmetrically around setpoint 1
- "r52" = PID-integral time (I-part)
- "r53" = PID-derivative time (D-part)
- "r54" = PID-actuator response time (T1-part)

How to influence the analog output manually

For certain applications it may be useful to affect the output signal manually. Any digital input can be assigned to a specific function. Once activated, the analogue output delivers a predefined voltage- or current signal, e.g. to drive a valve to a specific position.

- "h71"... "h74" set to "AnA" (Assignment Page) = configure digital inputs
- "r63" (Setpoint Page) = amount of the output in % of the selected range, if the digital input is activated.

Example:

Digital input D11 is configured at "h71" to the value "AnA", "r63" is set to "50".

- The Voltage Output delivers 5V DC
- The Current Output delivers 12 mA

Actuating Variable Delay for PID

For using control processes with large reaction times the controller offers an 'Actuating Variable Delay'.

Analogue Output

If the controller sends a signal which initiates the analogue output to rise or to fall, then an adjustable delay time (r56, Setpoint Page) starts. Within this time period, the output signal is able to alter only by a specific %-part (step size, r57). If "r57" is set to "100%" and "r56" to "0", then the function is disabled. This parameters affect to all PID functions which can be realized with the analogue output.

Reaching the The OFF-value

The OFF-value (0 or 100%) will be initiated immediately with:

- defrost initiation
- solenoid valve lock
- safety chain error
- controller OFF
- cooling OFF with an open door

Actuating Variable Delay Cool./Heating

Relay Output

In applications with motorized actuators, the Actuating Variable Delay takes effect by clocking the cooling resp. heating relays. If the controller sends a signal to initiate a relay permanently ON, an adjustable time period "r58" (Setpoint Page, Cooling/Heating Relay Time Period) starts. Within this period, the relay is engaged for the time set by "r59" (Setpoint page, Cooling/Heating Relay ON-Time).

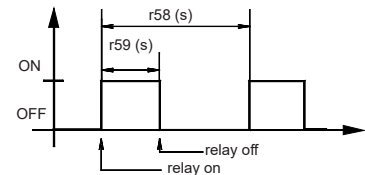

If "r59" is equal to "r58" or exceeds it, then the function is disabled, the relay switch as normal again.

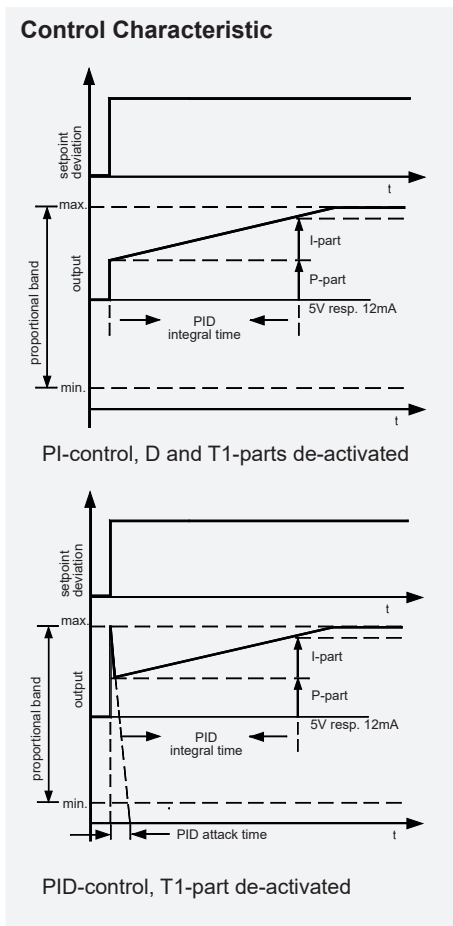

i Electronic Expansion Valves with analogue input

The analogue output is able to control expansion valves with analog input. Therefore, "h66" must be set to "EEP". Also in this case, "h67" serves as a switch for a voltage- or current output.

! Important !!

Please note the decreased lifetime of the relay contacts in cycling operation. Please care for a suitable relief.

Cycle 40 sec.:

- load current 0,8A res. --> 5 years
- load current 1,2A res. --> 2,5 year
- load current 1,9A res. --> 15 months

(Theoretical values according to the relays data sheet)

For this reason, please provide for a suitable relief or use an SSR-Out-pup.

Evaporator Fan Control

Each output relay can be configured for evaporator fan control. The fan control depends on the following parameters:

P03 (cooling mode, Mode Page)
 "nor" = refrigeration, fan will be switched by the N/O-contact of the fan relay
 "in" = (inverted) freezing, fan will be switched by the N/C-contact.



Only possible if an external relay with an N/C contact is connected which has the task to switch the fan.

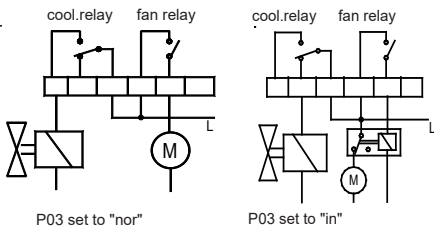

r14 (fan operation, Mode Page), defines the characteristic of the fan during the cooling period.
 "Int" = fan runs together with solenoid valve/compressor
 "PEr" = fan runs continuously while cooling
 "Add" = Using of latency heat by a special fan control + "Special mode for room temperatures > 2,5°C", as described in chapter "Intelligent Defrost".

d01 (fan during defrost, Defrost Page), defines the fan characteristic during the defrost cycle.
 "on" = during defrost, fan runs continuously
 "off" = fan is stopped during defrost.

Fan start-up (freeze-on) delay
 The start-up time delay for the fan after defrosting is defined by parameter "r22" (Setpoint Page). This avoids that water drops will be blown into the chamber. "L35" (Actual Values Page) show the remaining time up to the fan will switch on.

Thermostatic Fan Control
 If a sensor gets the function 'FAr', then the fan works depending on the parameters 'r15' (fan limitation value) and 'r16' (hysteresis of the fan limitation value). The fan stops, if the temperature at the sensor 'FAr' exceeds the value 'r15+r16' and will be restarted if 'r15' is reached again.

Examples for fan operation modes

- Fan in permanent mode**
 This mode is mainly used in refrigerated shelves, refrigerated display counters and chest freezers
 - fan is directly connected to mains voltage, not connected to the controller unit or
 - a relay is reserved for fan control, "r14" is set to "PEr", "d01" is set to "on". Drain-time "d35" is set to "0".
- Fan interval mode, defrost by fan**
 A relay is reserved for fan control, "r14" is set to "Int", "d01" is set to "on".
- Fan interval mode, defrost by electric heater/hot gaz:**
 A relay is reserved for fan control, "r14" is set to "Int", "d01" is set to "oFF". The fan runs while cooling is on, will be disabled during defrost periods and restarts delayed after defrost.
- Fan in permanent mode and defrost by electric heater**
 A relay is reserved for fan control, "r14" is set to "PEr", "d01" is set to "oFF". The fan will run continuously and stops during a defrost period only.

i Chances to exploit Latency Heat

1. Fan operation mode r14 = "Add"

- If temperature falls, cooling and fan will stop with reaching the control setpoint. If the room temperature rises to a value equal to *Control Setpoint + 1/2 Hysteresis*, the fans restart under the condition that the temperature of the evaporator (detected with limitation sensor) is lower than *Control Setpoint - 1/2 Hysteresis*. So remaining coldness will be blown into the room which reduces the number of compressor starts.
- Evaporators can be de-iced already at temperatures from 2°C by forced air. When cooling stops, fans are turning on until ice and frost are melted (limitation calculated within 2.0...5.0°C, cooling switches on at -3K). The switching point of the fan is always fixed 1K below. Thus humidity stays in the chamber which will improve the quality of certain goods like meat or vegetables. The 'rewetted' principle, that it is possible to defrost evaporators with air circulation at a temperature above +2°C, can so also be used while the cooling period.

! At room temperatures [setpoint+hysteresis => +2,5°C] notify to set parameter "d05" to a higher value, because a defrost start is forced if this time is past.

2. Fan trailing delay

To utilize latent energy, the fan is able to run for up to further 30 minutes after the cut-off of valve or compressor ("r23", Setpoint Page).

Fan operation modes, defrost termination using electric heaters

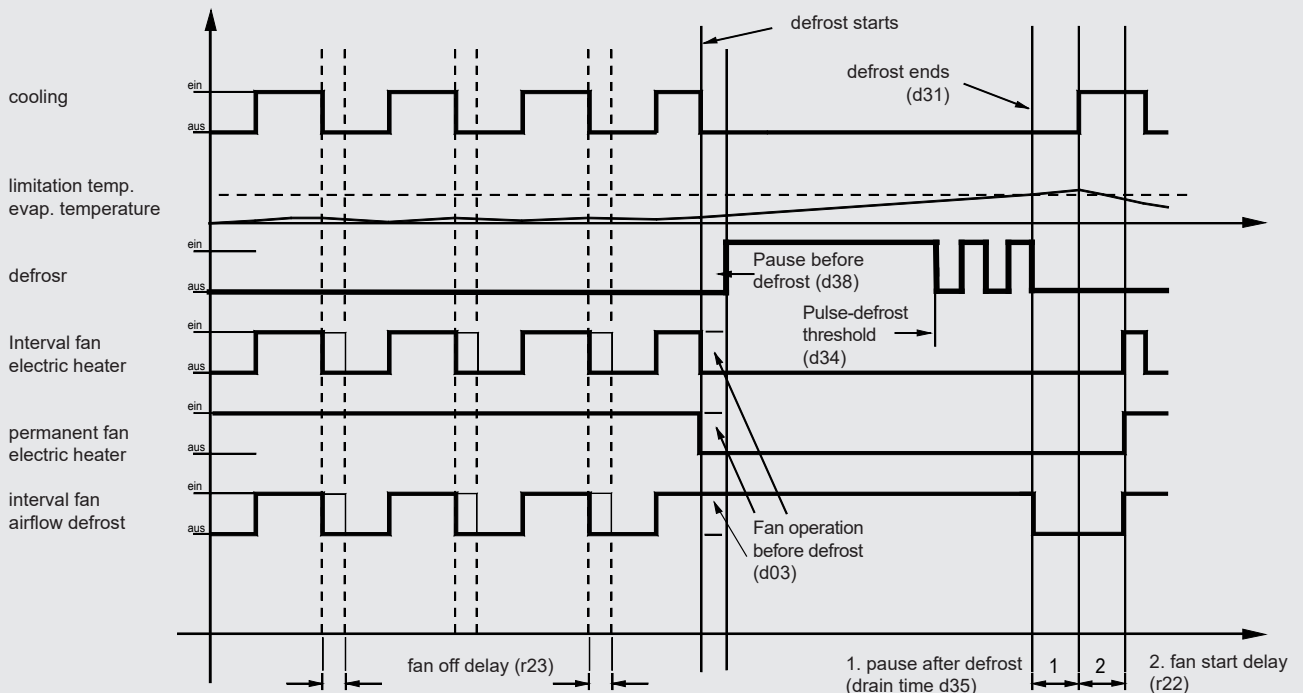

Roller Blind Control

To enable controlling roller blinds automatically, the function "roL" must be assigned to a relay output. The roller blind control is coupled to the day/night-mode, so the blind will be closed in night-mode. Defrosting overrides this function and opens the roller blind during a defrost period.

Internal control:

No digital input has got the functions "dnL" or "dnh", but if yet, the input must be set to day-mode. The switch times "P21" (night operat. ON) and "P22" (night operat. OFF, Mode Page) must be programmed.

Day-Mode: Roller blind relay is de-activated, so the motor will turn the blind to the 'open'-position via the relay's N/C contact.

Night -Mode: Roller blind relay will be activated to close the blind via the N/O contact of the relay.

External control

A digital input has got the function "dnL" or "dnh". Switch times "P21" and "P22" (night operation on/off) must be set to "oFF".

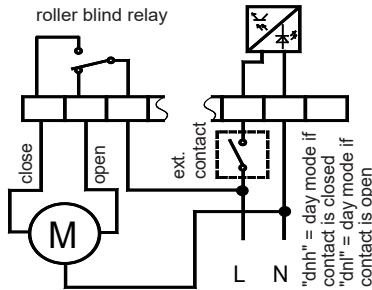

If the digital input is activated, the relay switches on and closes the roller blind. After de-activating the digital input, the relay switches off and opens the roller blind via its N/C-contact.

Frame Heater control

Frame heaters are used to avoid a door freezing onto the door frame. In addition it prevents condensing water around the door or on top of the frames of open chest freezers.

Power Optimization

To optimize the power requirement of the connected heaters, the controller is able to adapt the pulse ratio (within a specific range) to the current humidity of the ambient air (market temperature). The information about current market temperature and humidity the controller gets from a superior system (VPR 5240, can also be disabled there) to calculate the absolute humidity.

If one of the relays is assigned to "FrA", this will control the frame heater energy with a certain frequency and pulse-width. For day and night operation you can choose different values to save energy. The corresponding parameters on Mode Page are:

- "r35" defines the duration of the cycle,
- "r36" defines the percentage of heating during day operation within each cycle. 100% = continuous heating, 0% = off
- "r37" defines the percentage of heating during night operation within each cycle. 100% = continuous heating, 0% = off
- "L45" shows the current active ON-time of the heating, which may varied by a VPR host system.

Limit values

- Temperature: 19-24°C
- Air Humidity: 40-70% r.H.

At the upper limit, the pulse ratio is equivalent to the value set by r35...r37. At the lower limit, the ON-time decreases by the half value.

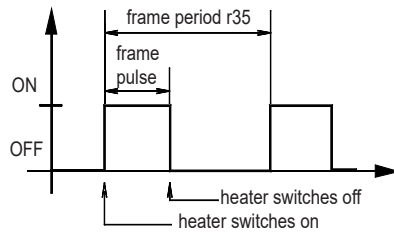

Cascading controller units to extend cold storages

To control multiple evaporators, up to 5 EVP-units can be added as slave modules. The communication between the first controller (master) and the slaves will be done via the 'slave module' interface

Necessary Settings

Master Unit ... Depending on the number of slave modules the parameter 'P88' (Mode Page) must be set from 'HS1' up to 'HS5'. The standard setting is 'HS0'.

Slave Unit Each Slave Unit get the order at 'P88' as which slave (SL1...SL5) it should operate.

- Network Address** Each Slave unit get an own address under parameter 'P90'.
- Cooling** "h93" = on
The slave unit gets a cooling request from the master if no control probe is selected at it. If a control probe is selected at it, the master gives only a cooling release to the slave and it will be cooled depending on its temperature probe.
- Pressure** 'h94' determines if the pressure value comes from the master or if the slave owns a separate pressure transducer.

i All information which are necessary for operating will be exchanged via the data interface from/to the Slave Modules.

- Pressure/Temperature Values to the slaves
- Defrost start/end (for synchronisation)
- Refrigeration lock
- Colling request from Master
- Defrost state of the slaves
- Addresses of the slaves to the master, so that a superior system (e.g. the VPR) knows, that this address pool is an address unit.

An additional wiring in not necessary.

Principle of cascading:

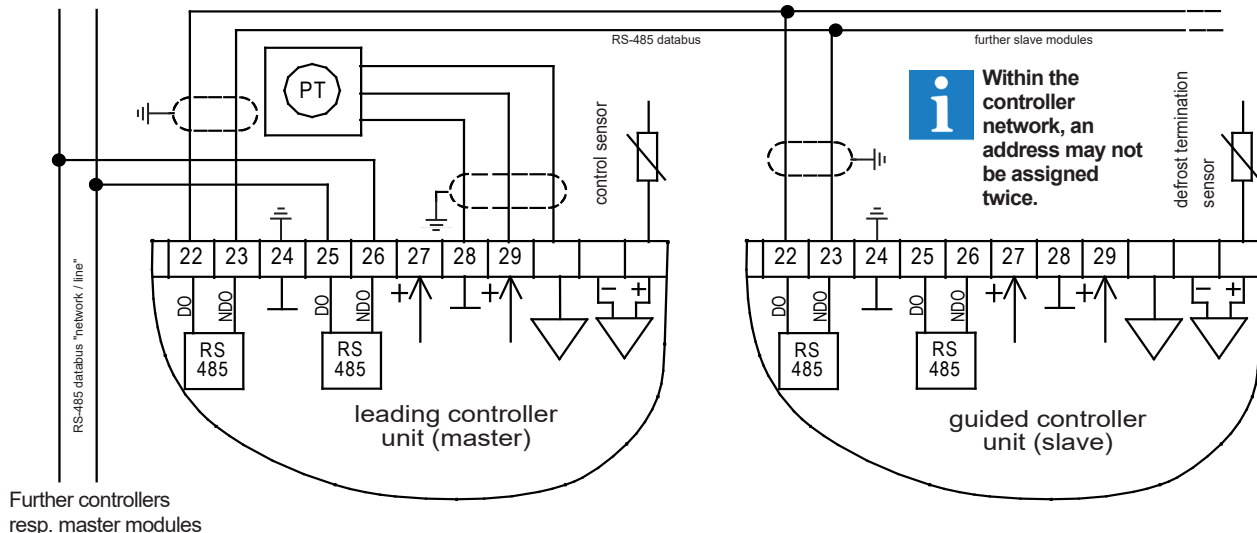

i Within the controller network, an address may not be assigned twice.

Networking of controllers via E-LINK

The EVP can be networked together with other ELREHA control devices via an RS-485-2-wire databus, which enables up to 78 controllers to communicate. For communication, the E-LINK transmission protocol is used. Each controller in a network has its individual address ("P90", Mode Page).

The data transmission rate is factory set to "96" (9600 Baud) and can also be set manually ("P89", Mode Page). If the controller is not connected to a network, these parameters are of no importance.

Configuration / Service via PC
The controller can be linked to a PC via its RS-485 interface. By using the PC-software „Coolvision-MES“, parameters can be changed, they can be saved to the hard disk (download) and can be send to other controllers (upload). To do this, the PC must be equipped with an RS-485 interface (internal card or a converter of the SSC-series).

 **!! Never use address 64 !!**

Remote control at Frontend Systems
EVP controllers can be operated remotely via interface when they are connected to Frontend Systems such as SMZ or VPR. In this case, the Frontend System shows the EVP's display contents and the keys of the frontend work as if they were the keys of the EVP.

Wiring of data lines

The scheme beside shows briefly, how the dataline wiring of several controllers via the 'network/line' interface is made. At each controller, the shield has to be connected to the nearest ground terminal (PE). Also the ground connector of the controller (term.1) and terminal #24 must be connected to the nearest ground terminal. This will assure good interference suppression, even for long datalines between the controllers.

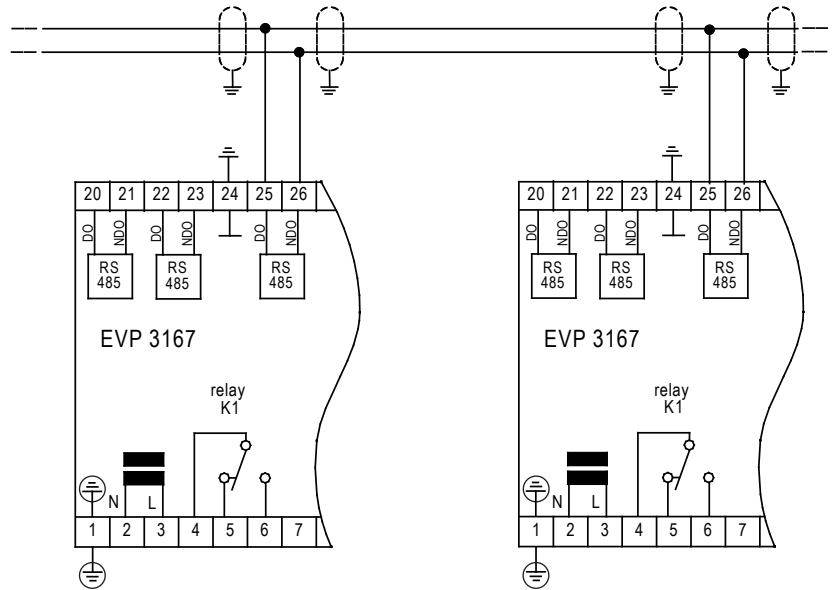

Communication with the VPR Compound Controller System

The EVP-controller can be used as intelligent cold storage controller in co-operation with the compound control system VPR. In this case, the VPR central processing unit monitors the EVP. When the EVP's are connected to the compound controller, each one needs an individual address ("P90", Mode Page). For the EVPs there is a possibility of assigning each controller to a certain compound ("P01", Mode Page). This allows the VPR to transmit specific information to the cold storage controllers assigned to the compound where a failure occurs. Additionally, the information exchange allows different optimizing methods for suction and condensing control. More detailed information you will find in the technical manuals of the VPR compound systems.

Behavior in case of a compound failure
If an EVP is assigned to a certain compound and a disturbance occurs, the unit responds as follows:

- The solenoid valves close
- The fan switches off
- A defrost will be terminated. A new defrost period is only possible after the compound problem is solved.

To see if this function is released, look at "L41" (Actual Values Page).
 "0" = solenoid valve closed
 "1" = solenoid valve open
 "oFF" = solenoid valve closed via interface

Data transmission disturbances
If the controller gets no new information from the VPR, it continues working with the current settings. If there was an order from the VPR to close the solenoid valves and a technical defect interrupts the data transmission for more than 30 minutes, the EVP ignores this order and starts working normally. When data transmission is restored, the EVP will work again immediately according to the commands of the VPR.

Connection of Remote Displays

The EVP 3167 is designed for connecting remote displays of the TAA xx15 series. These types are able to display (optionally) the actual values 'L01' up to 'L06' and 'L08'. The connection at the controller must be done via the RS-485 interface 1 (term. 20/21). Multiple TAA xx15 units can be connected, each is able to display any probe value.

 **The EVP is able to supply 3 TAA displays only, if you need more displays, an external power supply is necessary!**

Display while defrost
If leading controller works in a defrost period, the TAA Remote Display works as it was configured at the controller. The assigned function 'HLd' determines if the TAA 'stores' the last measured value before the defrost phase on the display or if it shows the current temperature value.

Power Supply
The power can be supplied from the EVP controller or from an external transformer.

Parameterizing
At the EVP controller no settings are necessary. At the TAA display the number of the probe to display must be selected with the switch at the backside of the housing.

- Probe/Transducer 1-5: Address 1-5
- Actual value of the pressure transducer: Adr. 6
- Virtual sensor: Address 7

More information for a connection you can find in the individual data sheet of the Remote Display.

Sensor Positions

Sensor positions are not critical in standard applications. The **control sensor** or **alarm sensor** has to be fixed behind the evaporator (air-inlet) or at a representative place in the chamber, but not in the air outlet.

The second sensor (**defrost term-inati-on sensor, evaporator sensor**) should be assembled in the contact pipe or within the fins of the evaporator. A good thermal exchange to the fins is important. It should be placed at the position where the ice remains the longest time while a defrost cycle.

Sensors for intelligent/adaptive defrost
To detecting the EVP doesn't need additional sensors. The control sensor and the defrost (evap.) sensor are sufficient. Please note that the emergency defrost mode is not able to prevent ice-clusters or slow glaciation in case of an incorrect sensor position. If ice-clusters appear, the defrost sensor must be placed at this position.

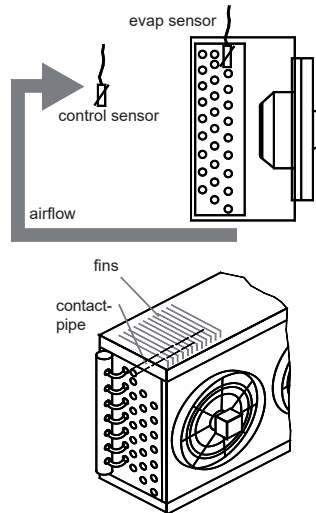

Sensor positions for EEx-Valve Control, Pressure Transmitter / Temperature Sensor Method

The pressure transmitter must be mounted at the suction pipe, at a position where no pressure decrease can affect the measuring. The best place is close to the evaporator. If there are several evaporators, select a position from where the distance to all evaporators is as short as possible.

Selection of Pressure Transmitter

To detect a pressure transmitter malfunction, the signal voltage input is scalable. So you can use e.g. transmitters with an 2...10V output which makes it easier to recognize a malfunction.

Number of controllers working with the same pressure transmitter

The input resistance of the pressure transmitter input is 69 kOhm. Several inputs can be connected in parallel, but the resulting resistance must not fall below the minimum specifications of the used pressure transmitter. In practise, up to 10 controllers mostly work trouble-free.

Sensor positions for EEx-Valve control, Temperature Sensors Method

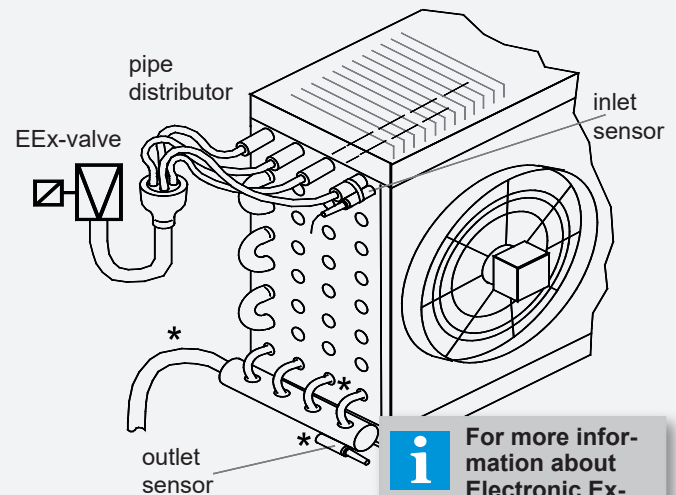

i For more information about Electronic Expansion Valves see page 11 !

* = alternative positions for Outlet-Sensor

Please care for a good isolation by foamed material, so that none of the sensors get contact with the airflow.

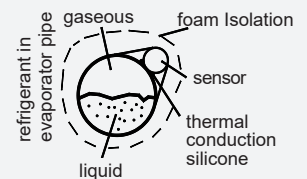

Pipe mounting

Most expedient is it to use **cable fixers**, some thermal conduction silicone cares for a good thermal flow.

Metallic fixers with high mass are not qualified.



After start-up, Please check the position of the evaporator sensors accurately!!

Notice

Installation / Start-Up

Upon applying voltage to the controller, after a few seconds the display shows the parameter which is selected as permanent display or an actual error code.

Start-up sequence

- Assign inputs/outputs to functions (see example on page 3)
- Select type of used temperature sensors ("h68", Mode Page),
For plants with EEx-valves, use TF 501 types only!
- Correct the displayed temperature values if necessary ("P31"- "P36", Mode Page).
- Set date and time ("P80"- "P85", Mode Page)
- Set defrost mode ("d02", Defrost Page)
- Set fan mode "d01" and "r14"
- Set cooling mode "P03" (Mode Page)
- See page 11 for parameterization of the pressure transmitter inputs

These are the most important steps for the basic configuration of the controller. Upon that, adapt the other parameters like temperature setpoint, hysteresis, delay times.... Refer to the previous chapters in this manual.

Start-up in a data network

- Set the address of the controller ("P90", Mode Page)
- Upload parameters from PC to controller

The EVP offers several status messages, which enables you to check the states of inputs and outputs:

- "L50", value of the analogue output
- "L55", battery state of an EVS stepper motor module
- "L60", state of the digital inputs DI1 and DI4
- "L61", state of the relays 1-5

Commissioning for connecting multiple controllers (Master/Slave-Mode)

- see page 16



This manual, which is part of the product, has been set up with care and our best knowledge, but mistakes are still possible. Technical details can be changed without notice, especially the software. Please note that the described functions are only valid for units containing the software with the version-number shown on page 1 of this manual. Units with an other version number may work a little bit different.