

LED

## LED Spot W & LED powerdrive

UV LED flood lamp

Max. irradiation intensity: up to 30.000 mW/cm<sup>2</sup>

Wavelength: 365, 385, 395, 405 and 460 nm

Water cooled

### System features

- Very small lamp head design
- Extremely long LED service life
- Available in different wavelengths
- Intelligent power control
- Controller for one, two or three LED Spot W available

### Advantages

- Reduction of maintenance costs
- Homogeneous irradiation of larger areas
- Suitable for temperature sensitive materials
- No warm-up phase
- No standby-time
- Clean room capable

## LED Spot W & LED powerdrive

The **LED Spot W** provides a **most intensive UV irradiation on a larger area**, while having only **very small space requirements**. Thanks to the external water cooling the extremely small lamp head design offers highest intensity. As the LED Spot does not require an integrated fan, it can also be used in a clean room environment.

The quadrate light emitting aperture has a size of 20 mm x 20 mm. Depending on the selected intensity/homogeneity it can be increased considerably by changing the distance to the substrate.

The LED Spot allows for a very flexible use due to its high intensity and the possibility to control the LEDs in a cycle time  $< 100 \mu\text{s}$  externally. Thus, it is possible to realize **shortest cycle and machine throughput times**, especially in fully automated production lines.



LED Spot W

In addition, the LED Spot W features the characteristic advantages of the **LED-technology, as for example the typical LED service life of more than 20.000 hours\***. Furthermore, the LEDs can be switched on and off as often as necessary, without any heating or cooling phase.

The emitted wavelengths are available in 365/385/395/405/460 nm  $\pm 10$  nm. It is thus possible to adapt the LED head to any application in question.

## Applications

The LED Spot W controlled by the LED **powerdrive** controller is appropriate for various applications, such as

- Bonding, fixing or encapsulating of components in the electronic, optical or medical-technical sector
- Fluorescence stimulation for materials testing; also suitable for automatic image processing
- High-intensive UV irradiation in the chemical, biological and pharmaceutical sector
- UV-irradiation for different applications in a clean room

## LED Spot control

The LED **powerdrive** allows the independent operation of up to **3 LED Spots W**. The adjustment of the irradiation time is freely selectable in the ranges of 0.01 - 99.99 sec. or 0.1 - 999.9 sec pr 1 - 9999 sec. Alternatively, continuous operation can be chosen.

The operating status and the temperature of the LED segments as well as the irradiation time can be seen on the display at a glance. **The electrical LED power can be adjusted between 2 % and 100 % in 1 %-steps.**

The device is recording the LED operating hours and the service menu gives comprehensive information about the current operation status.

In addition the LED **powerdrive** controller is characterized by the following features:

- Large and clearly arranged display
- Intelligent power control
- LED temperature and error monitoring
- Shortest cycle time (0.01 s when set via display /  $100 \mu\text{s}$  with external control)

## Interfaces

The LED **powerdrive** controller has the following interfaces:

- Analog preselected target value 0,2V - 10V  $\pm$  2% - 100%
- PLC inputs: LED on, LED enable
- PLC outputs: LED is on, LED is off, LED error, LED warning
- Dry relay contact function (see PLC outputs) or for driving an external cooling device
- Foot switch
- LED enable signal

## Technical data

LED service life	> 20.000 hours*
adjustment range of timer (in seconds)	0,01 - 99,99 or 0,1 - 999,9 or 1- 9999 or continuous operation
wavelength in nm	365 385 395 405 460
typ. intensity in mW/cm <sup>2</sup> **	14000 16000 25000 25000 30000
power supply	90 V – 264 V, 47 Hz – 63 Hz
max. input current	2,2 A
Power rating	200 W
dimensions LED-head without connectors (H x B x T)	ca. 60 x 50 x 17 mm
cooling	External water cooling

\* typical lifetime under specified operating conditions

\*\* measured with Hönle LED sensors for UV meter

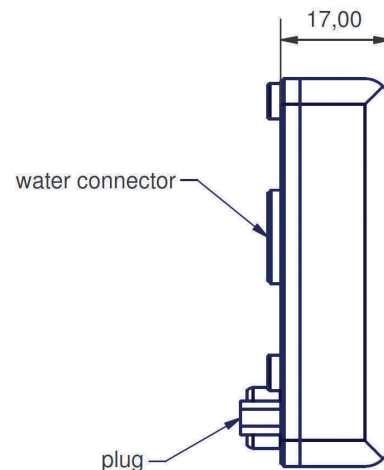
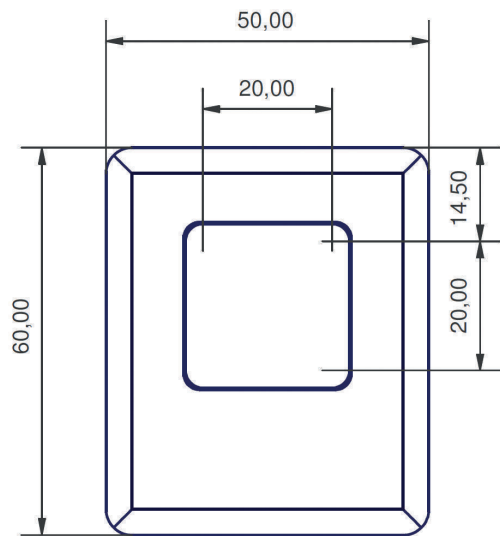

## Advantages of the LED technology

LEDs **do not emit IR radiation**. Due to the inferior temperature load of the substrate, even **temperature-sensitive materials** can be irradiated. The **different spectra** available guarantee a safe and fast curing.

As LEDs do not require a warm-up phase, LED heads can be switched on and off without any problems: **they are immediately ready for operation**.

## More Hönle LED-Units

Water cooled type  
Air cooled type

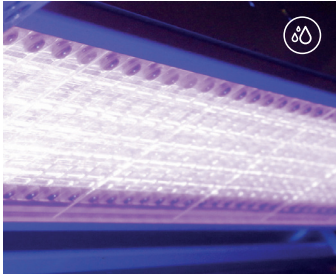

**LED Powerline Focus**  
Almost distance-independent high intensity due to focusing optics.



**LED Powerline LC**  
Maximal length depends on application (lengths variable in 40 mm-steps).  
The LED Powerline LC is available in the wavelengths 365/385/395/405 nm.



**jetCURE LED**  
Modularly controll- and changeable (grid 41 mm) as well as continuously adjustable. Available in two versions which differ in their cooling air duct.

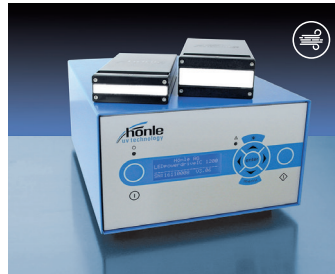

**LED Powerline AC/IC**  
Air cooled high-performance UV LED array optional with LED powerdrive IC.



**LED Spot 40 IC**  
The LED Spot 40 IC was developed for all applications requiring a compact flood unit with high intensities.



**LED Spot 100 IC / HP IC**  
The square light-emitting aperture has a size of about 100 mm x 100 mm. For bigger irradiation fields, several LED Spots 100 can be connected without gaps.



**bluepoint LED eco**  
bluepoint LED eco has been developed for all applications requiring a most intensive punctiform UV irradiation.



**LED Power Pen 2.0**  
This handy LED point source is available in the wavelengths 365 nm and 405 nm. Depending on the wavelength it is able to generate UVA-intensities of either 10.000 mW/cm<sup>2</sup> or 16.000 mW/cm<sup>2</sup>.

**hönle group**

Disinfecting

Curing

Drying

Bonding

Potting

Measuring

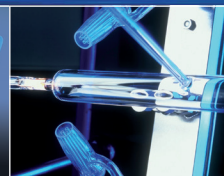
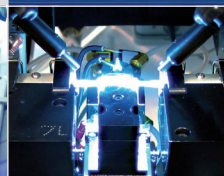
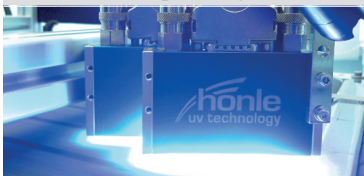

eleco panacol-efd

eltosch grafix

gepa coating

hönle

panacol

printconcept

raesch

sterilsystems

technigraf

umex

uv-technik speziallampen



DIN EN ISO 9001  
DIN EN ISO 14001



Dr. Hönle AG UV Technology, Nicolaus-Otto-Str. 2, 82205 Gilching, Germany  
Phone: +49 49 8105 2083-0, Fax: +49 8105 2083-148. [www.hoenle.de](http://www.hoenle.de)

Operating parameters depend on production characteristics and may differ from the foregoing information.  
We reserve the right to modify technical data. © Copyright Dr. Hönle AG. Updated 05/22