

Pressure switch with one switching output
TS51

Technical Features

- › Pressure switch with an adjustable pressure switch point
- › Simple switch point setting by means of setting ring allowing optimum reading
- › High long-term stability thanks to robust stainless-steel measuring cell with high permissible pressure rating
- › Mechanical locking prevents inadvertent switch point manipulation
- › High vibration and shock resistance
- › Service-life more than 50 million pressure cycles
- › For use in hydraulics, pneumatics, air-conditioning and refrigeration
- › UL approval and certification acc. to PED direction

Functional Description

Pressure switch with a stainless-steel measuring cell and an adjustable pressure switch point. The position of adjusting ring with a scale is protected with a mechanical lock. The stainless-steel body is provided with connecting thread G1/4 with FKM sealing ring. An electric connection is realized by four-pin connector M12x1. The pressure switch is suitable for industrial usage thanks to robust design, vibration and shock resistance. Outputs: switching contact (pin 4)

Technical Data

Application			
Type		TS51-250	TS51-400
Measuring range	bar (PSI)	0 ...250 (0 ...3630)	0 ...400 (0 ...5800)
Set point SP	bar (PSI)	7.5 ...250 (109 ...3630)	12 ...400 (174 ...5800)
Hysteresis	bar (PSI)	5 (73)	8 (116)
Pressure range	bar (PSI)	400 (5800)	600 (8700)
Min. bursting pressure	bar (PSI)	1000 (14500)	1600 (23200)
Media		Liquids	
Medium temperature	°C (°F)	-25 +80 (-13 ... +176)	
Ambient temperature	°C (°F)	-25 +80 (-13 ... +176)	
Storage temperature	°C (°F)	-40 +100 (-40 ... +212)	
Electrical parameters			
Supply voltage	V DC	9.6 ... 32	
Current consumption	mA	< 25	
Min. insulation resistance	MΩ	100 (500 V DC)	
Protection class		III	
IP protection		IP67	
Protection		Reverse polarity protection	
Outputs			
One digital output		Switching signal; PNP switcher (contacts normally open)	
Max. voltage drop switching output DC	V	2	
Permanent current rating of switching output DC	mA	500	
Switching frequency DC	Hz	< 100	
Electric protection		Pulsed short-circuit and overload protection	
Accuracy / deviations			
Switch point accuracy	%	< ± 2.5 (of the final value), setting accuracy	
Repeatability	%	< ± 0.5 (of the final value); with temperature fluctuations < 10 K	
Characteristics deviation	%	< ± 1.5 (of the final value) Best fit straight line (BFSL) < ± 2.5 (of the final value) Limit value setting (LS)	
Temperature drift per 10K	%	< ± 0.5	
Adjusting			
Adjustment of the switch point		Setting ring with a mechanical lock	
Tests / approvals			
EMC		DIN EN 61000-4-2 ESD EN 61000-4-3 HF radiated EN 61000-4-4 Burst EN 61000-4-6 HF conducted	4 kV CD / 8 kV AD 10 V/m 2 kV 10 V
Shock resistance		DIN IEC 68-2-27	50 g (11 ms)
Vibration resistance		DIN IEC 68-2-6	20 g (10 ...2000 Hz)
MTTF	years	576	1030

Mechanical parameters			
Weight	kg (lbs)	0.093 (0.21)	0.095 (0.21)
Materials		Stainless steel (1.4404/316L); PBT; PC; FKM	
Materials (wetted parts)		Stainless steel (1.4404/316L); FKM	
Min. pressure cycles		50 million	
Tightening torque	Nm (lbf.ft)	25 (18.4)	
Circuit connection		External thread G1/4 (DIN EN ISO 1179-2); Internal thread M5 for restrictor	
Sealing ring		FKM (DIN 3869)	
Display, operating elements			
Display		Operation – LED green Switching status – LED yellow	
Electrical connection			
Connector		4-pin, M12x1	

Dimensions in millimeters (in)

TS51

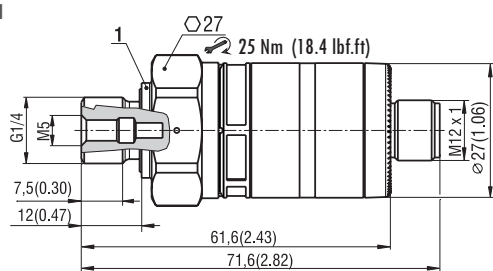

Pos.	Name	Type
1	Square ring	16.5x1.5 VITON

Electrical connection

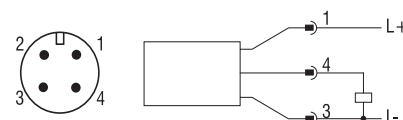

Connector without cable

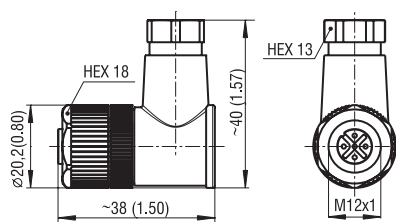

Connector with cable

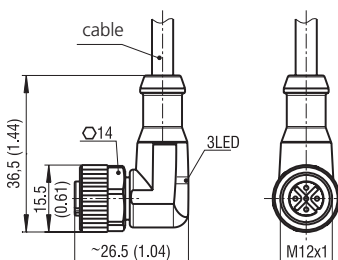

Connector type	Ordering No.
without cable	41349600
2m cable	41582300
5m cable	41825200

Connector is **not included** in order of any pressure switch or sensor and has to be ordered separately.

Ordering Code

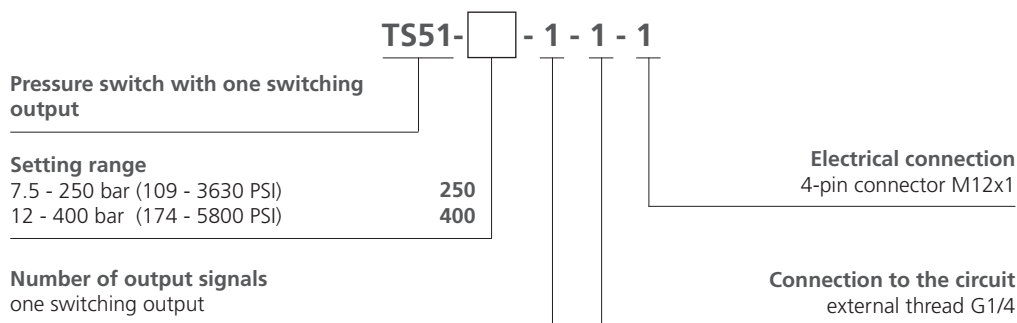

Reduction plate in millimeters (in)

For substitution of **TS4** pressure switch use combination of TS51 with reduction plate RD-TS5

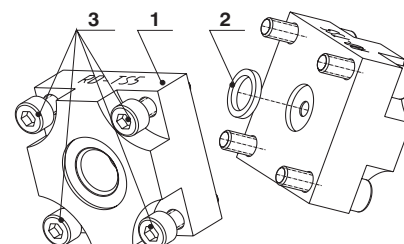
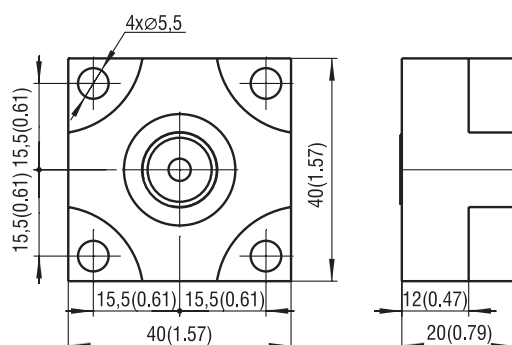

Kit	Pos.	Name +Type	Pos.	Name +Type	Pos.	Name +Type	Ordering No.
RD-TS5-N	1	Adapter RD-TS5 (PO-B)	2	Square ring 9.25x1.68 NBR 70	3	Bolt M5x20	42807300
	1	Adapter RD-TS5 (PO-B)	2	O-ring 9.25x1.78 V90	3	Bolt M5x20	42807400