

D732 LED Remote Display – Data Sheet

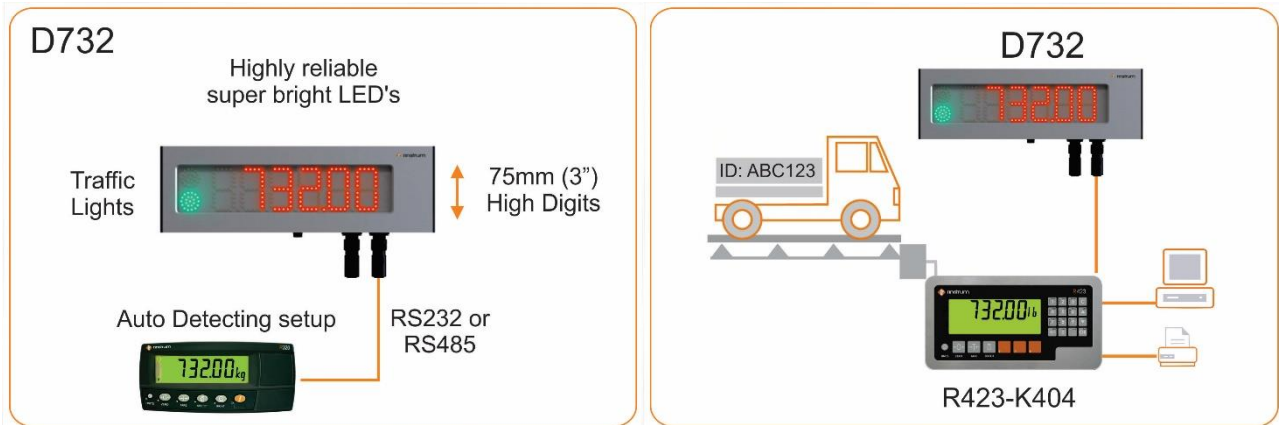

- Super Bright LEDs
- Wide viewing angle
- Suitable for external use
- Isolated RS232/485 Serial Input
- Traffic lights
- Auto detecting setup
- Compatible with Rinstrum indicators

The D732 is a 7 segment super bright RED LED remote with 75mm (3") high digits and traffic lights. It is an ideal economical display for weigh bridges and truck scales. The D732 is suitable for industrial applications both indoors and out, and features:

- Isolated RS232/RS485 serial input;
- Protocol compatible with Rinstrum indicators and systems that support Rinstrum/Range A and C and PC Modes.
- Greater than 30m /99 feet at 120 degrees viewing angle
- 10 step auto adjusting brightness

Traffic Lights: 35mm/1.4" red and green traffic lights that can be driven via the communications protocol.

Decimal Point: The decimal point is displayed between digits as a single LED and does not affect number of digits displayed.

Configurator PC Software: Allows for configuration via the PC - unit addressing in PC mode for multi-drop applications and brightness and time out can be set.

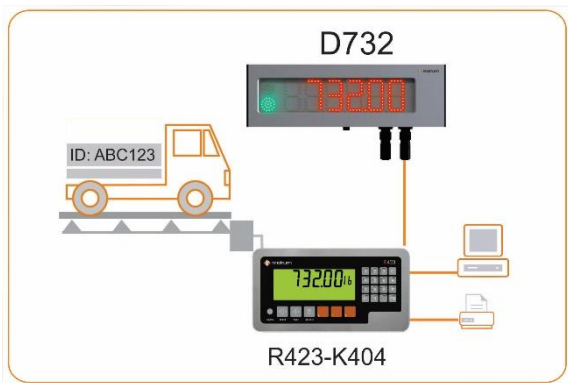

Ideal for Truck or Axle Scales Applications

Team the D732 remote display up with an R400 Series indicator (R420 ABS or R423 Stainless Steel)

- K404 firmware for Truck Scales
- K405 firmware for Axle Scales

...now that's smart weighing

D841\D850 LED Remote Displays – Data Sheet



- Super Bright LEDs
- Wide viewing angle
- VAC/VDC Power Options
- Isolated RS232/485 Serial Input or Ethernet
- Alpha numeric characters for improved readability
- Auto detecting setup
- Compatibility with large range of indicator manufacturers
- Unit switching**
- Annunciators**

The D841 and D850 are super bright RED LED displays that feature alpha-numeric characters allowing for improved clarity in messaging. This is ideal for concrete batching plants or custom site management applications where non-weight related messages such as material names need to be displayed. The D841 and D850 supports the majority of printable ASCII characters. These displays are part of Rinstrum's range of remotes that are built for both indoor and outdoor industrial applications.

Visibility:

- D841 - >50m (164 feet) at 120 degrees viewing angle
- D850 - >70m (230 feet) at 120 degrees viewing angle

Unit Switching**:

- D841 and D850 allows for kg, lb, t and g units to show on display

Traffic Lights:** The D841 traffic lights (50mm/2 inch round red and green) can be driven from discrete inputs or directly via the communications protocol. The universal inputs will accept clean contact switches or voltages 5-24VDC to control the traffic lights.

Decimal Point:

The decimal point will be displayed between digits as two LEDs in the D841 and the D850. The decimal point does not affect number of digits displayed.

Scrolling Messaging (D841 only):

The D841 can be fitted with K802 firmware for moving messages to interface with a PC or equivalent device. With a fixed format text string length of up to 150 characters it is ideal for providing instructional messages to truck drivers or equipment operators. (K802 firmware option is factory fit only).

** Where unit switching, traffic lights and annunciators are support in the protocol.

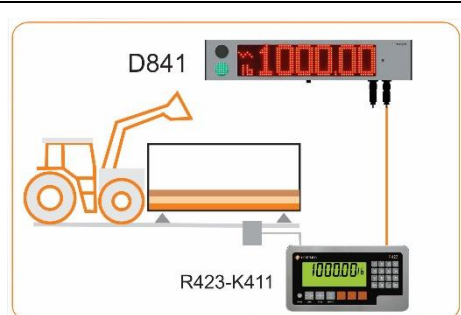

Alpha Numeric Characters for improved readability

- D841 and D850 have 14 x 64 LED matrix at 14 x 8 LED's per character allowing for the majority of printable ASCII characters to be displayed

...now that's smart weighing

Specification Table

		D732	D841	D850
Display	Super Bright LED's			
		28 LED's per digit 7 Segment Numeric characters, Single row of LEDs	Alpha numeric characters Double row of LEDs	
Digits		Six (6) digits	Six (6) digits + Annunciators or Seven (7) digits	
Digit Height		75mm (3in)	100mm (4in)	140mm (5.5in)
Visibility		20m (66 feet)	30m (100 feet)	70m (230 feet)
Traffic Lights		Dedicated Red/Green	Dedicated Red/Green	-
Annunciators		-	Motion, Centre of Zero, Net	
Unit Switching (Protocol Dependent)			Display Units (either right or left hand side) Adhesive sticker	
AC Power		110-240VAC 50/60Hz 32W MAX	110-240VAC 50/60Hz 32W MAX	
DC Power (Factory fit)		-	24VDC (18–36VDC) or 12VDC (9–18VDC) 30 W MAX	
Scrolling Messages (Factory fit)		-	K802 Firmware 150 character text strings slow/medium/fast scroll rate	-
Viewing Angle		120 ° from all directions		
Brightness Control		Steps 1-10; Automatically to ambient lighting		
Operating Environment		Temperature: -20 to +60°C case temperature (-4 °F to 140 °F)		
		Humidity:<90%rh non-condensing		
Setup		Auto detecting to compatible indicators		
Memory		Full non-volatile operation		
Interfaces		RS232 – RS485 receive		
		-	Ethernet (Factory fit alternative to serial)	
Set Up		-	Via external data connector (DA004) and remote display configurator software (D800- 500)	
Approvals		FCC, CE, C-tick		
Environment Rating		IP65		
Mounting Options	Weather Hood	D73x Weather Hood (DA001)	D84x Weather Hood (DA002)	-
	Mounting Plate	VESA and RAM compatible mounting points (DA003)		-
Dimensions		488x150x80mm 19x6x3.2in	770x150x80mm 30.3x6x3.2in	811x200x80mm 31.9x8x3.2in
Weight		3.3kg (7.3lb)	4.2 kg (10.2lb)	7.4kg (16.3lb)
Ethernet Interface		No	Factory fit	Factory fit

Specifications are subject to variation for improvement without notice - Illustrations are indications only and variation may be evident between products

D732

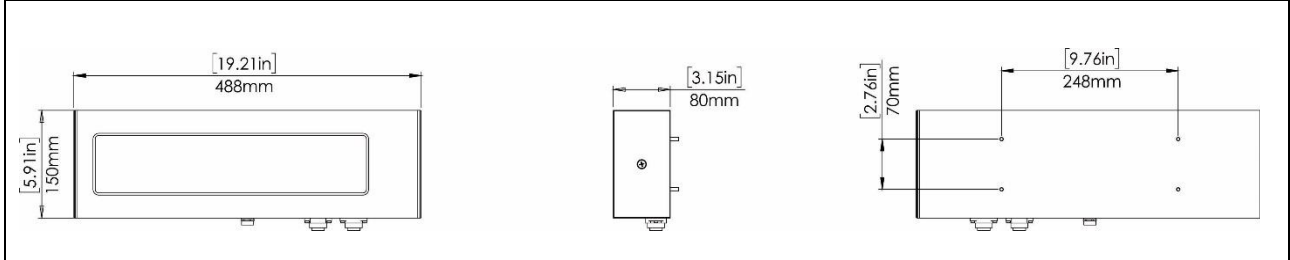

D841

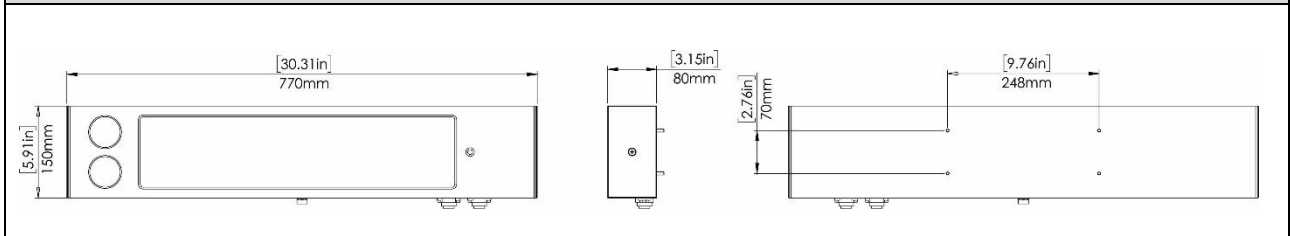

D850

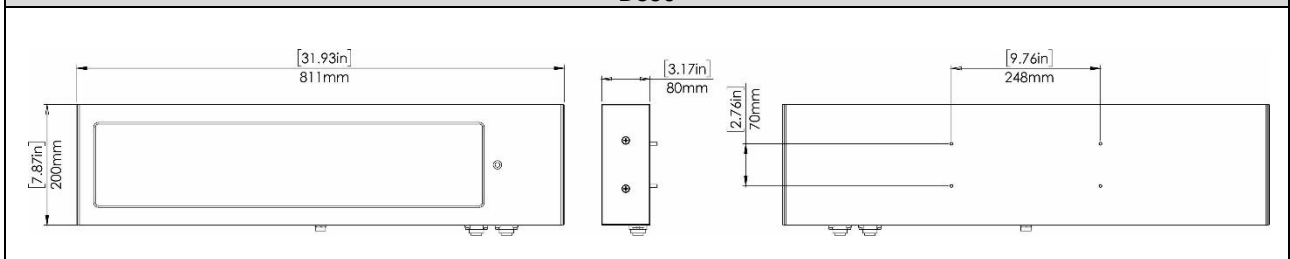

DA001 and DA002

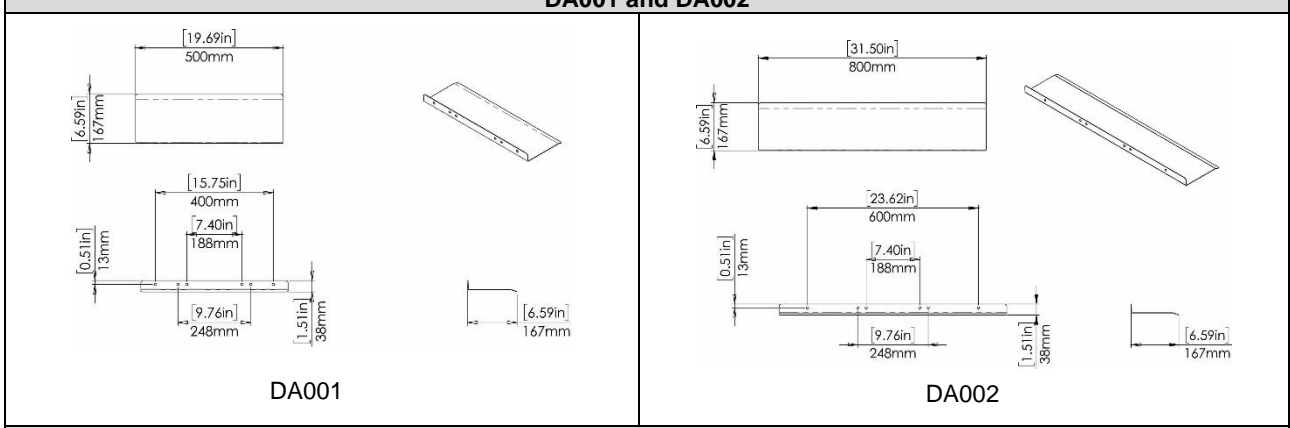

DA003

