

Earth-Rite® II RTR™

Static Earthing for Road Tankers

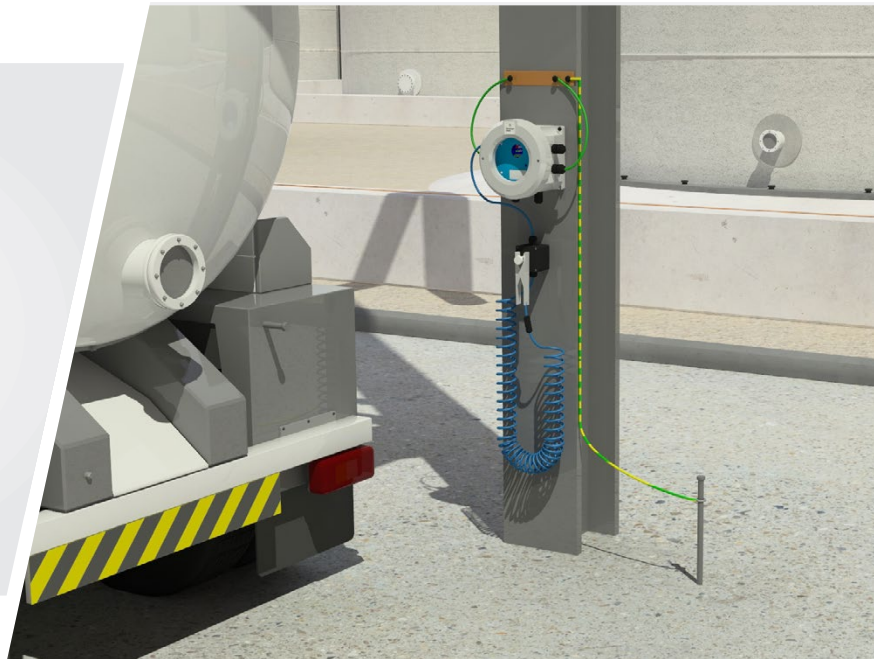

Earth-Rite II RTR Road Tanker Earthing System



The Earth-Rite II RTR is designed to ground a road tanker during loading and unloading operations in order to dissipate any static electricity which could accumulate on a road tanker during these processes.

CLC/TR 60079-32-1 "Explosive Atmospheres: Electrostatic Hazards - Guidance" highlights road tankers as being capable of accumulating electrostatic charge during product transfer operations.

To mitigate against the accumulation of static on the body of the road tanker, it recommends that trucks be grounded during the transfer procedure.

The Earth-Rite II RTR static grounding system is designed to provide grounding of road tankers to mitigate against static discharges from the main body of the road tanker.

The system consists of a red/green LED ground status indicator and dry contacts that can be interlocked with the process or an additional strobe light.



The Earth-Rite II RTR includes:

- **Flameproof and GRP Enclosures** incorporating Intrinsically Safe Static Ground Monitoring System
- **Ground Connection Junction Box** with Clamp Stowage Point and Quick Release Connector
- **Heavy Duty Stainless Steel Universal Grounding Clamp** with Hytrel® Extendable Cable and Quick Connectors

Earth-Rite® II RTR™

Patented Tri-Mode Technology Explained

MODE 1 AND 2

With the grounding clamp and cable attached to the designated earth point on the road tanker through its patented circuitry the Earth-Rite II RTR detects the presence of the road tanker by its capacitance and not by impedance, resistance or the presence of a diode on the road tanker.

At the same time the patented circuitry ensures that it has a connection to the general mass of the earth. This is a critical step as a connection to earth is the only means by which the static electricity can be transferred from the teeth of the clamp on the road tanker to earth thereby mitigating the accumulation of static electricity during the transfer.

MODE 3

Once Modes 1 and 2 have been completed successfully the patented circuitry monitors the loop resistance from between the teeth of the clamp on the road tanker to the designated general mass of the earth through the Earth-Rite II systems G1 and G2 connections. The circuitry will monitor the loop resistance and if it exceeds 10 Ohms it will stop the transfer.

This 10 Ohms loop monitoring requirement is detailed in the following standard/s and recommendations:

IEC TS 60079-32-1:2017

Clauses 7.3.2.3.3, 7.11.2, 8.8.4, 10.1.2, 10.1.4, 13.2.2, 13.3.1.1, 13.3.1.4, 13.4.1 & G.11.2

NFPA 77:2019 Clause 7.4.1.3.1

API RP 2003 8th Edition Clause 4.2.2

* Always check for and read the latest version of the International Standards, Guidance and/or Recommended Practices.

The repeatability of the 10 Ohm loop monitoring has been Third Party validated by CSA/SIRA

ATTENTION:

Driver / operator training is essential for the correct use of the grounding system. The first action in the material transfer process is grounding of the road tanker. The Earth-Rite II RTR clamp should be connected directly to the designated earthing point of the road tanker. The grounding clamp should NOT be removed until all other procedures in the material transfer process are complete.

All metal components on the road tanker should have an electrical continuity not exceeding 10 Ohms. Isolated metal components should not be present on the road tanker. If isolated metal components are present on the road tanker they could possess a capacitance similar to that of the main road tanker body.



Pulsing LEDs confirm positive ground condition

Volt free interlock contacts

Earth-Rite II system output contacts can be interlocked with process equipment and/or strobes. Interlocking the grounding system with the process equipment can enhance the Standard Operating Procedures (SOP) before the movement of material can take place. Interlocking with strobes provides personnel with a wider field of view that the grounding SOP is underway.

On rare occasions grounding clamps can be removed by operators or lose contact with equipment due to unstable connections being made initially or overstretching of the cable connected to the grounding clamp. The grounding system, can, via the output contacts, halt the process. However, it should be borne in mind that the movement of the product may not stop even though the equipment (pump / impeller) has halted. This could lead to the continued generation of static charge. In such circumstances it is the responsibility of the site operator to ensure their SOPs cater for such scenarios. This assumes the grounding system has been installed in accordance with the Instruction Manual. If you do not have access to an Instruction Manual contact Newson Gale.

Earth-Rite® II RTR™

Technical Specification

Exd (Zone 1 Gas / Vapour Atmosphere - Zone 21 & 22 Dust Atmospheres)

Monitoring Unit

Power Supply	115 V or 230 V AC, 50-60 Hz 12 V or 24 V DC
Power Rating	10 watt
Ambient Temperature Range	-40°C to +55°C
Ingress Protection	IP 66
Weight	4.5 kgs (9.9 lbs) nett
Construction	Copper-free cast aluminium
Monitoring Circuit	Intrinsically safe
Monitoring Loop Resistance	Nominally ≤ 10 Ohm ($\pm 10\%$)
Output Relay Contact Rating	2 off voltage free change-over switch contacts 250 V AC 5 A 500 VA max resistive 30 V DC 2 A 60 W max resistive
Cable Entries	7 x M20 (2 x plugged)

Junction Box/Stowage Point

Enclosure Material	GRP with carbon loading
Terminals	2 x 2.5 mm ² conductor capacity
Stowage Device	Insulated universal stowage pin
Cable Entries	1 x 20 mm
Clamp Cable Connection	Quick Connect

Grounding Clamp

Clamp Design	2 pole with tungsten carbide teeth
Body	Stainless steel (SS grade: 304)
ATEX / FM / IECEx Certification:	Ex II 1 GD T6 (Assessed to EN 13463-1 : 2009) ATEX certificate number: Sira 02ATEX9381 FM Certificate of Compliance number: 3046346 IECEx Ex h IIC T6 Ga Ex h IIIC T85°C Da Ta = -40°C to +60°C IECEx EXV 20.0033

Spiral Cable

Cable	Blue Cen-Stat Hytel sheath (Static dissipative, chemical & abrasion resistant)
Conductors	2 x 1.00 mm ² copper
Length	3 m (10 ft), 5 m (16 ft), 10 m (32 ft) or 15 m (50 ft) 2 pole Cen-Stat blue spiral cable with Hytel coating which has colour, UV protective and static dissipative additives

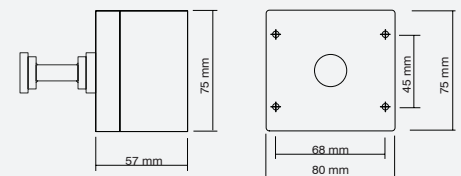
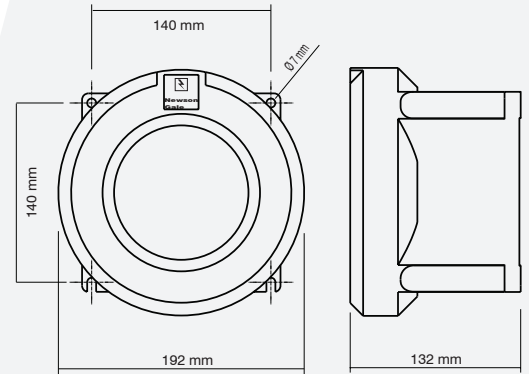

Simple Apparatus
GRP junction box with nylon grounding clamp stowage pin

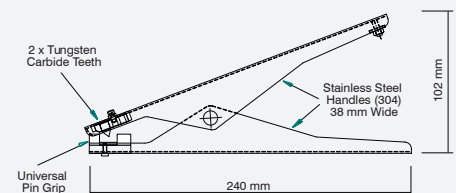

Static Grounding Clamp

Dual core stainless steel grounding clamp fitted with one pair of tungsten carbide tips

Earth-Rite® II RTR™

Hazardous Area Certification

Europe / International:

IECEX

Ex d[ia] IIC T6 Gb(Ga) (gas & vapour)
 Ex tb IIIC T80°C IP66 Db
 (combustible dusts)
 Ta = -40°C to +55°C
 IECEx EXV 19.0052
 IECEx Certifying Body: ExVeritas

ATEX

⚡ II 2(1)GD
 Ex d[ia] IIC T6 Gb(Ga)
 Ex tb IIIC T80°C IP66 Db
 Ta = -40°C to +55°C
 ExVeritas 19ATEX0537
 ATEX Notified Body: ExVeritas

North America Version Available:

NEC 500 / CEC (Class & Division)

Associated Equipment [Ex ia] for use in
 Class I, Div. 1, Groups A, B, C, D
 Class II, Div. 1, Groups E, F, G
 Class III, Div. 1
 Providing intrinsically safe circuits for
 Class I, Div. 1, Groups A, B, C, D
 Class II, Div. 1, Groups E, F, G
 Class III, Div. 1
 When installed per Control Dwg;
 ERII-Q-10110 cCSAus
 Ta = -40°C to +50°C (-40°F to +122°F)

OSHA recognised NRTL: CSA

NEC 505 & 506 (Class & Zoning)

Class I, Zone 1 [0] AEx d[ia] IIC T6 Gb(Ga)
 (gas & vapour)
 Class II, Zone 21 [20] AEx tD [iaD] 21
 T80°C (combustible dusts)

CEC Section 18 (Class & Zoning)

Class I, Zone 1 [0] Ex d[ia] IIC T6 Gb(Ga)
 DIP A21, IP66, T80°C

Additional Certification

Safety Integrity Level:

SIL 2 (in accordance with IEC/EN 61508)

EMC Tested:

to EN 61000-6-3, EN 61000-6-2
 FCC - Part 15 (Class B)

Earth-Rite® II RTR™

Technical Specification

GRP (Zone 2 Gas / Vapour Atmosphere - Zone 21 & 22 Dust Atmospheres)

Power Supply & Monitoring-Unit

Power Supply	115 V or 230 V AC, 50-60 Hz 12 V or 24 V DC
Power Rating	10 watt
Ambient Temperature Range	-25°C to +55°C
Ingress Protection	IP 66
Weight	2 kgs (4.4 lbs) nett
Construction	Carbon-loaded GRP
Monitoring Circuit	Intrinsically safe
Monitoring Loop Resistance	Nominally ≤ 10 Ohm ($\pm 10\%$)
Output Relay Contact Rating	2 off voltage free change-over switch contacts 250 V AC 5 A 500 VA max resistive 30 V DC 2 A 60 W max resistive
Cable Entries	7 x M20 (2 x plugged)

Junction Box/Stowage Point

Enclosure Material	GRP with carbon loading
Terminals	2 x 2.5 mm ² conductor capacity
Stowage Device	Insulated universal stowage pin
Cable Entries	1 x 20 mm
Clamp Cable Connection	Quick Connect

Grounding Clamp

Clamp Design	2 pole with tungsten carbide teeth
Body	Stainless steel (SS grade: 304)
ATEX / FM / IECEx Certification:	Ex II 1 GD T6 (Assessed to EN 13463-1 : 2009) ATEX certificate number: Sira 02ATEX9381 FM Certificate of Compliance number: 3046346 IECEx Ex h IIC T6 Ga Ex h IIIC T85°C Da Ta = -40°C to +60°C IECEx EXV 20.0033

Spiral Cable

Cable	Blue Cen-Stat Hytrel sheath (Static dissipative, chemical & abrasion resistant)
Conductors	2 x 1.00 mm ² copper
Length	3 m (10 ft), 5 m (16 ft), 10 m (32 ft) or 15 m (50 ft) 2 pole Cen-Stat blue spiral cable with Hytrel coating which has colour, UV protective and static dissipative additives

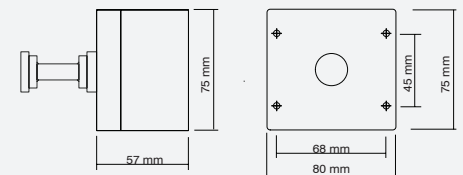
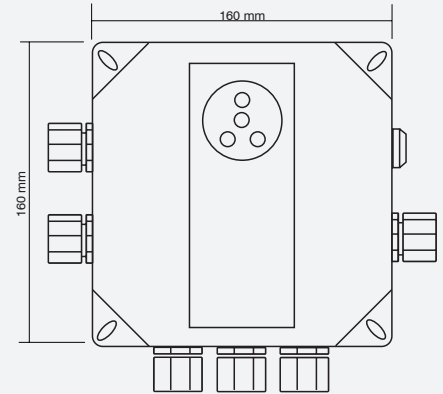

Simple Apparatus
GRP junction box with nylon grounding clamp stowage pin

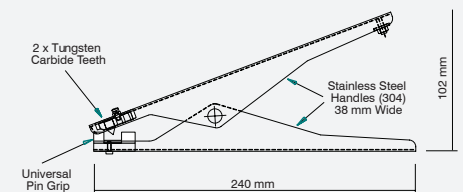

Static Grounding Clamp

Dual core stainless steel grounding clamp fitted with one pair of tungsten carbide tips

Earth-Rite® II RTR™

Hazardous Area Certification

Europe / International:

IECEX

Ex ec nC [ia] IIC T4 Gc(Ga)
 (gas & vapour)
 Ex tb IIIC T70°C Db
 (combustible dusts)
 Ta = -40°C to +55°C
 IECEX EXV 19.0059X
 IECEX Certifying Body: ExVeritas

ATEX

⚡ II 3(1) G
 Ex II 2D
 Ex ec nC [ia] IIC T4 Gc(Ga)
 Ex tb IIIC T70°C Db
 Ta = -40°C to +55°C
 ExVeritas 19ATEX0545X
 ATEX Notified Body: ExVeritas

North America Version Available:

NEC 500 / CEC (Class & Division)

Associated Equipment [Ex ia] for use in
 Class I, Div. 2, Groups A, B, C, D
 Class II, Div. 2, Groups E, F, G
 Class III, Div. 2
 Providing Intrinsically Safe circuits for
 Class I, Div. 1, Groups A, B, C, D
 Class II, Div. 1, Groups E, F, G
 Class III, Div. 1

When installed per Control Dwg;
 ERII-Q-10165 cCSAus
 Ta = -25°C to +55°C (-13°F to +131°F)

OSHA recognised NRTL: CSA

NEC 505 & 506 (Class & Zoning)

Class I, Zone 2, (Zone 0), AEx nA[ia] IIC T4
 (gas & vapour)
 Class II, Zone 21, AEx tD[iaD] 21, T70°C
 (combustible dusts)

CEC Section 18 (Class & Zoning)

Class I, Zone 2 (Zone 0) Ex nA[ia] IIC T4
 DIP A21, IP66, T70°C

Additional Certification

Safety Integrity Level:

SIL 2 (in accordance with IEC/EN 61508)

EMC Tested:

to EN 61000-6-3, EN 61000-6-2
 FCC - Part 15 (Class B)

System Options

Installer's Kit

The kits provide installation engineers with the necessary Ex (d) enclosure glands required to complete an **Earth-Rite II RTR** installation as specified in the system installation manual.

Kit A

Ex (d) IP68 glands (x2) for armoured cable 9 mm to 13.5 mm Ø*,
Ex (d) IP68 glands (x3) for non-armoured cable 4 mm to 8.4 mm Ø*,
IP68 plastic gland for junction box cable, 3m of 2 core conductor cable (x1) to connect system enclosure to clamp stowage box, 1m of solid green earth loop cable (x2) with PCB connectors and 10 mm bolt eyelets attached.

Kit B

Ex (d) IP68 glands (x5) for non-armoured cable 4 mm to 8.4 mm Ø*,
IP68 plastic gland for junction box cable, 3m of 2 core conductor cable (x1) to connect system enclosure to clamp stowage box, 1m of solid green earth loop cable (x2) with PCB connectors and 10 mm bolt eyelets attached.

Kit C (GRP/P1)

Ex (e) IP68 glands (x5) for non-armoured cable 6 mm to 13 mm Ø,
IP68 plastic gland for junction box cable, 3m of 2 core conductor cable (x1) to connect system enclosure to clamp stowage box, 1m of solid green earth loop cable (x2) with PCB connectors and 10 mm bolt eyelets attached.

* For areas not requiring IIC apparatus.

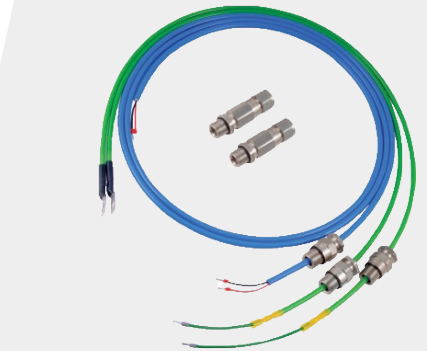

Kit A - with Ex d glands, for use with armoured cable

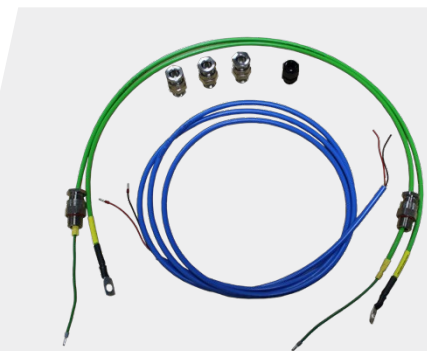

Kit B - with Ex d glands, for use with non-armoured cable



Kit C - with Ex e glands, for use with non-armoured cable

System Options

Earth-Rite II RTR Tester

The **Earth-Rite II RTR Tester** is a capacitance resistance tester (CRT) designed to have the same electrical characteristics as a road tanker and provides engineers with a means of checking that the **Earth-Rite II RTR** undergoing installation is permissible when it detects these characteristics.

The Tester is connected to the **Earth-Rite II RTR** system and its grounding point, and when activated, the **Earth-Rite II RTR's** LED indicators change from red to green, confirming that the Road Tanker Recognition and Static Ground Verification checks are functioning as intended.

The CRT is highly recommended with a minimum of one per site.

- Required for system commissioning and routine service checks
- Easy to use with simple PASS / FAIL condition



Retractable Cable Reel

The Retractable Cable Reel is supplied for grounding system installations where customers want to ensure the grounding clamp and cable are returned to the static grounding system by operators and drivers on completion of the product transfer process. The reel can be used in conjunction with the **Earth-Rite II RTR**.

- Certified for ATEX Zone 1 and 21 hazardous areas
- Self-retracting with up to 15 m of Hytrel® protected cable
- Silver plated ultra low resistance slip ring contacts
- ATEX - Ⓜ II 2 GD T6



Sun Shield

Designed for operating environments subject to intense sunlight, the ER II Sun Shield protects against direct sunlight hitting the indicators on the **Earth-Rite II RTR** static grounding system.

The Sun Shield casts a shadow over the indicators during peak sun light hours so that operators can easily view the ground status indicators. The shield is constructed from stainless steel and can be fitted to any installation in a matter of minutes.



System Options

Intrinsically Safe (I.S) Switching PCB

The I.S Switching PCB is an additional circuit board added to Newson Gale system enclosures to enable users to directly interface with, and switch intrinsically safe circuits without the need for additional equipment. The I.S Switching PCB is designed not to affect the I.S signals electrical parameters and is compatible with the Earth-Rite II RTR.

- 30 V DC, 500 mA
- $L_i = 0H$, $C_i = 0F$
- Suitable for Ex ia, ib, ic rated intrinsically safe circuits only
- NAMUR Compatible



Ex Strobe Light

The strobe light is mounted in an elevated position and when the equipment is correctly grounded, flashes continuously informing personnel that a transfer process is underway and is protected from the static hazard. The strobe light can be used in conjunction with the Earth-Rite II RTR.

- 115 V / 230 V AC and 24 V DC options
- ATEX / IECEx approved Exd strobe light
- II 2G Ex d IIC T4 (Ta. -50°C to +70°C)
- II 2G Ex d IIC T5 (Ta. -50°C to +40°C)
- II 2D Ex tD A21 IP67 T125°C based on max. Ta. 70°C



Copyright Notice

The website and its content is copyright of Newson Gale Ltd © 2020. All rights reserved.

Any redistribution or reproduction of part or all of the contents in any form is prohibited other than the following:

- you may print or download to a local hard disk extracts for your personal and noncommercial use only
- you may copy the content to individual third parties for their personal use, but only if you acknowledge the website as the source of the material

You may not, except with our express written permission, distribute or commercially exploit the content. Nor may you transmit it or store it in any other website or other form of electronic retrieval system.

Right to change

This document provides general information only and may be subject to change at any time without notice. All information, representations, links or other messages may be changed by Newson Gale at any time without prior notice or explanation.

Newson Gale is not obliged to remove any outdated information from its content or to expressly mark it as being outdated. Please seek the advice of professionals as necessary regarding the evaluation of any content.

Disclaimer of liability

The information provided in this Datasheet is provided by Newson Gale without any representations or warranties, expressed or implied, as to its accuracy or completeness. The liability of Newson Gale for any expenses, losses or actions incurred whatsoever by the recipient as a result of the use of this Datasheet shall be excluded.

Leading the way in hazardous area static control



www.newson-gale.com

9/9

United Kingdom
Newson Gale Ltd
Omega House
Private Road 8
Colwick, Nottingham
NG4 2JX, UK
+44 (0)115 940 7500
groundit@newson-gale.co.uk

United States
IEP Technologies LLC
417-1 South Street
Marlborough, MA 01752
USA
+1 732 961 7610
groundit@newson-gale.com

Deutschland
IEP Technologies GmbH
Kaiserswerther Str. 85C
40878 Ratingen
Germany
+49 (0)2102 58890
erdung@newson-gale.de