

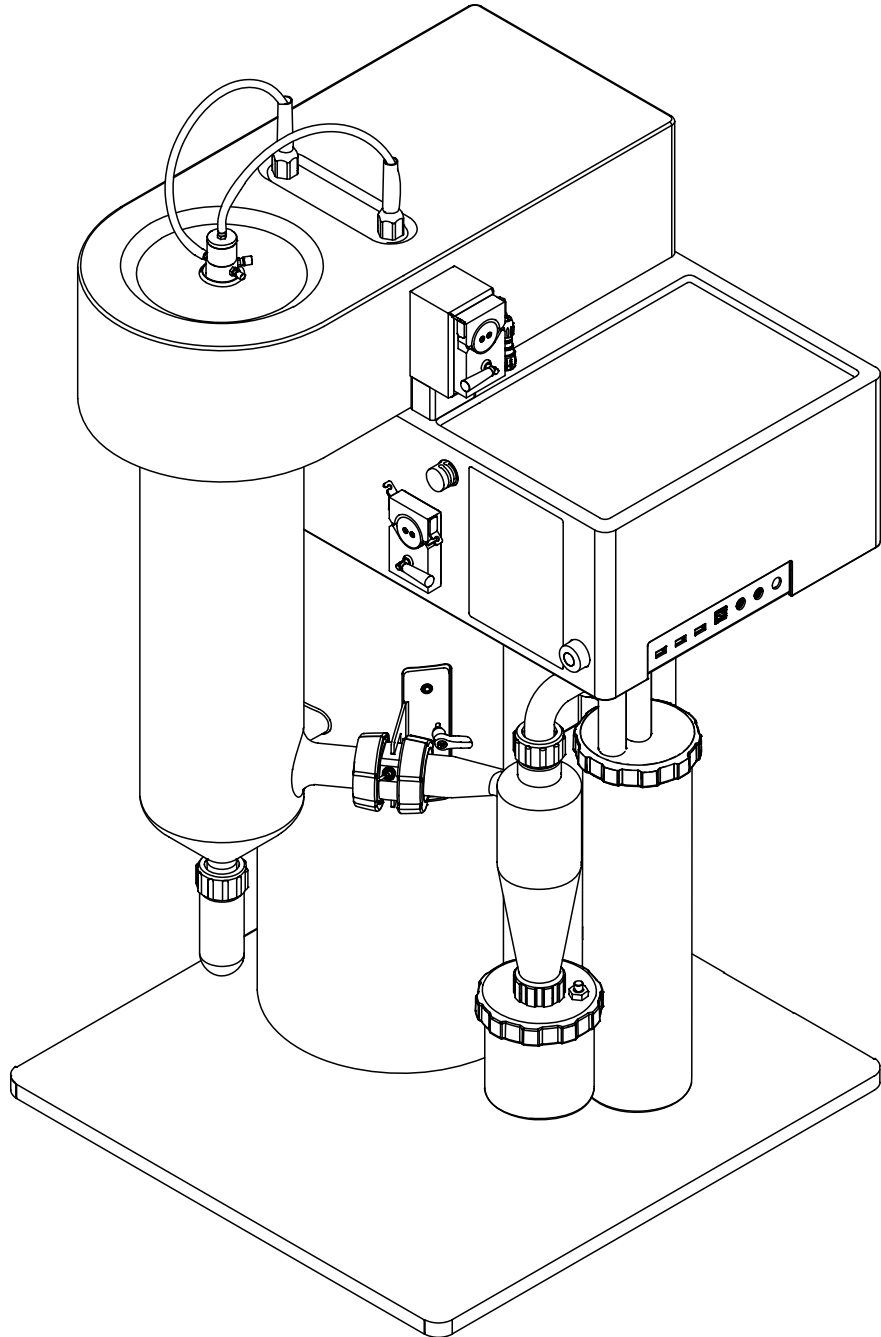

# Mini Spray Dryer S-300

Technical data sheet



## Scope of delivery

All configurations are supplied ready to use.

Component	Mini Spray Dryer S-300	Mini Spray Dryer S-300	Mini Spray Dryer S-300
		Advanced	Corrosive
Instrument	1	1	1
Two fluid nozzle, complete	1	1	-
Two fluid nozzle corrosive, complete	-	-	1
Nozzle cleaning brush	1	1	1
Hose clip 25-40 DIN3017	1	1	-
Compressed gas hose	1	1	1
Hose adapter 4/2	1	1	1
Hose coupling	1	1	1
Power supply	1	1	1
Hose Tygon MH2075	-	1	1
Hose Tygon HCF4040A	-	1	1
Feed switch valve	-	1 (only Pro)	1 (only Pro)
Ultrasonic Package S-300	-	-	- (not available)

## Order code

Choose the configuration according to your needs:

**1 1 S 3 0 0** **1** **1 0 0**

Version

- B Mini Spray Dryer S-300
- A Mini Spray Dryer S-300 Advanced
- C Mini Spray Dryer S-300 Corrosive

Auto mode

- 0 No auto mode
- 1 With auto mode (Advanced and Corrosive only)

Temperature

- 0 220°C
- 1 250°C (Advanced and Corrosive only)

## Technical data

### Mini Spray Dryer S-300

	Mini Spray Dryer S-300	Mini Spray Dryer S-300 Advanced	Mini Spray Dryer S-300 Corrosive
Dimensions (W x D x H)	620 mm x 640 mm x 1052 mm	620 mm x 640 mm x 1052 mm	620 mm x 640 mm x 1052 mm
Weight (without glass assembly)	54.0 kg	54.0 kg	54.0 kg
Weight (with glass assembly)	62.5 kg	62.5 kg	62.5 kg
Connection voltage	220 - 240 ± 10 % VAC	220 - 240 ± 10 % VAC	220 - 240 ± 10 % VAC
Heating Control	± 3 °C	± 3 °C	± 3 °C
Power consumption	max. 2300 W	max. 2300 W	max. 2300 W
Fuse	10 AT	10 AT	10 AT
Overvoltage category	II	II	II
Frequency	50 / 60 Hz	50 / 60 Hz	50 / 60 Hz
IP Code	IP20	IP20	IP20
Pollution degree	2	2	2
Minimum clearance on all sides	100 mm	100 mm	100 mm
Spray drying gas	Nitrogen Compressed air	Nitrogen Compressed air	Nitrogen Compressed air
Pressure range	6.5 - 7.0 bar	6.5 - 7.0 bar	6.5 - 7.0 bar
Spray gas range	80 - 1800 L/h	80 - 1800 L/h	80 - 1800 L/h
Max. temperature	220 °C	220 / 250 °C	220 / 250 °C
Max. flow rate	35 m <sup>3</sup> /h	35 m <sup>3</sup> /h	35 m <sup>3</sup> /h
Sample feed	0.1 - 30.0 mL/min	0.1 - 30.0 mL/min	0.1 - 30.0 mL/min
External connection dry-ing gas	KF25	KF25	KF25

	Mini Spray Dryer S-300	Mini Spray Dryer S-300 Advanced	Mini Spray Dryer S-300 Corrosive
Certificate	CSA / CE	CSA / CE	CSA / CE

## Ambient conditions

For indoor use only.

Max. altitude above sea level	2000 m
Ambient and storage temperature	5 – 40 °C
Maximum relative humidity	80% for temperatures up to 31 °C decreasing linearly to 50 % relative humidity at 40 °C

## Spare parts and accessories

### Nozzles

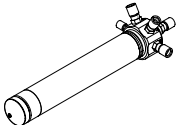
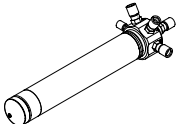
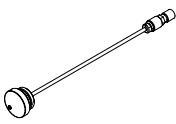
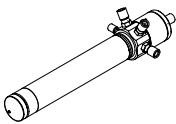
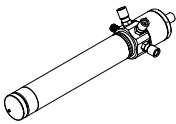
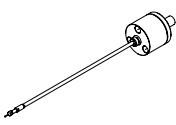
	Order no.	Image
Three-fluid nozzle, complete Nozzle for two independent sample feeds at the same time. Allows to spray dry immiscible samples for microencapsulation applications.	046555	
Three-fluid nozzle corrosives, complete	11056971	
Three-fluid nozzle conversion kit	046556	
Two-fluid nozzle 1.5 mm, complete	044698	
Two-fluid nozzle corrosives, complete	11056320	
Nozzle cleaning 0.7 mm, complete	044643	

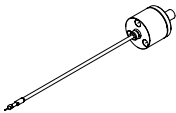
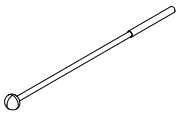
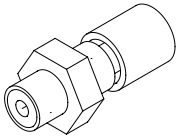
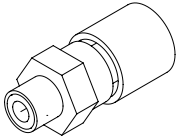
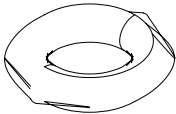
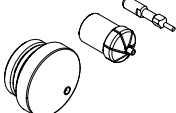
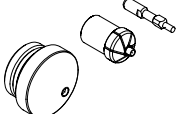
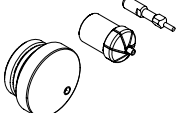
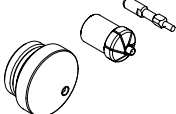
	Order no.	Image
Nozzle cleaning 0.7 mm acid proof, complete	11059876	
Cleaning brush for nozzle	044782	
Screw connection product tube	044628	
Screw connection air and cooling	044629	
O-ring for nozzle cleaner, FKM (black), 2x 3.00 x 1.50 mm	044469	
Set nozzle 1.4 mm Wider diameter for the two fluid nozzle to work with viscous sample materials.	046380	
Set nozzle 2.0 mm Wider diameter for the two fluid nozzle to work with viscous sample materials.	046381	
Nozzle set 1.4 mm titanium	11056415	
Nozzle set 2.0 mm titanium	11056416	

## Nozzle needles

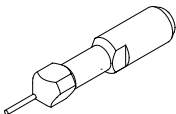
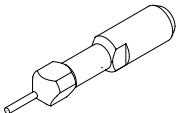
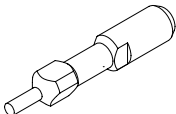
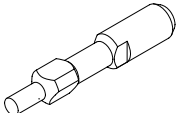
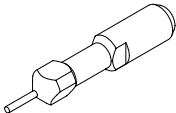
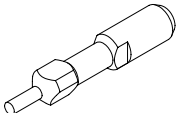
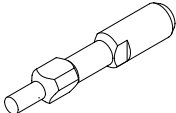
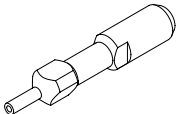
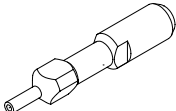
	Order no.	Image
Needle 0.5 mm	11056864	
Needle 0.7 mm	044618	
Needle 1.4 mm	046372	
Needle 2.0 mm	046373	
Needle 0.7 mm titanium	11056315	
Needle 1.4 mm titanium	11056417	
Needle 2.0 mm titanium	11056422	
Needle 0.7 mm empty	046554	
Needle 0.7 mm titanium empty	11056969	

## Nozzle tips

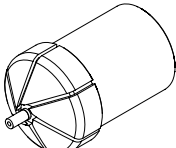
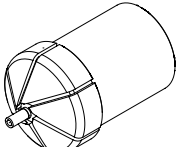
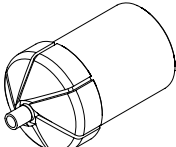
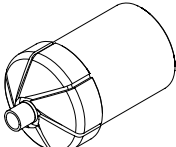
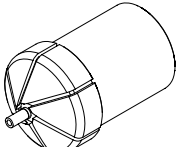
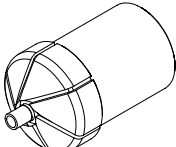
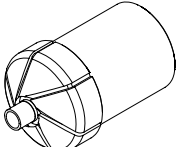
	Order no.	Image
Nozzle tip 0.5 mm	11056865	
Nozzle tip 0.7 mm	044634	
Nozzle tip 1.4 mm	046376	
Nozzle tip 2.0 mm	046377	
Nozzle tip 0.7 mm titanium	11056317	
Nozzle tip 1.4 mm titanium	11056419	
Nozzle tip 2.0 mm titanium	11056424	

## Nozzle caps

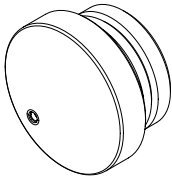
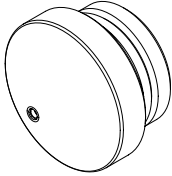
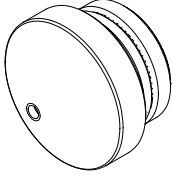
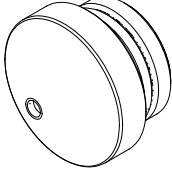
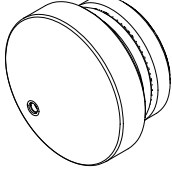
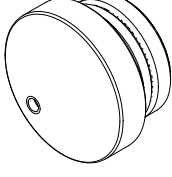
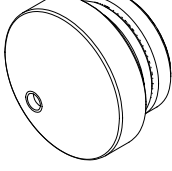
	Order no.	Image
Nozzle cap 1.4 mm	044649	
Nozzle cap 1.5 mm	044647	
Nozzle cap 2.2 mm	046374	
Nozzle cap 2.8 mm	046375	
Nozzle cap 1.5 mm titanium	11057509	
Nozzle cap 2.2 mm titanium	11057510	
Nozzle cap 2.8 mm titanium	11057511	





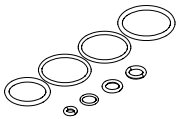
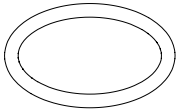
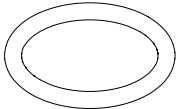
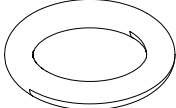
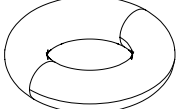
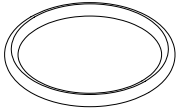
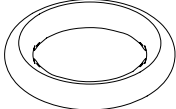

## O-rings nozzle

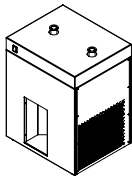
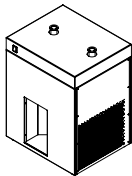
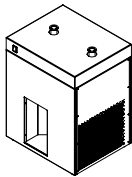
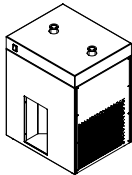
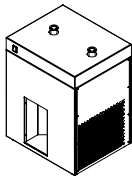
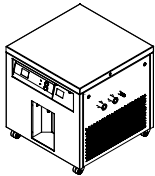
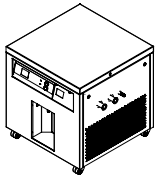
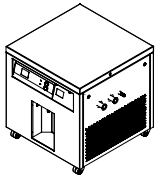
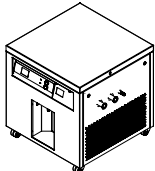
	Order no.	Image
Set of O-rings for nozzle	044759	
O-ring for nozzle, FKM (green), 2x 21.00 x 2.00 mm	044645	
O-ring nozzle cap silicone (red), 2x 16.00 x 2.00 mm	002103	
O-ring for needle and nozzle tip, FKM (green), 4 x 6.00 x 1.50 mm	004222	
O-ring for nozzle cleaner, FKM (black), 2x 3.00 x 1.50 mm	038348	
O-ring for screw coupling, FFKM (black) 2x 37.69 x 3.53 mm	046363	
O-ring for nozzle tip, FFKM (green), 2x 6.00 x 1.50 mm	046361	

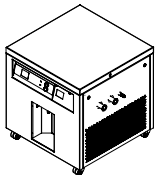
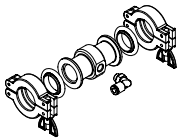
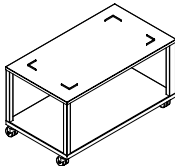
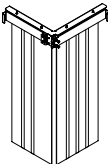
## Accessories

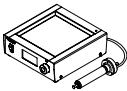
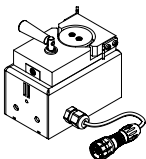
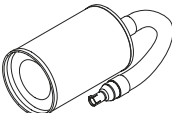
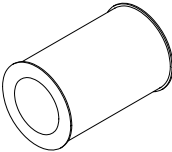
	Order no.	Image
Dehumidifier S-396 200 V	11073817	
Dehumidifier S-396 210 V	11073816	
Dehumidifier S-396 220 V	11074006	
Dehumidifier S-396 230 V	11073814	
Dehumidifier S-396 240 V	11073815	
Inert Loop S-395 200V 50Hz	11074620	
Inert Loop S-395 220-240V 50Hz	11074621	
Inert Loop S-395 200V 60Hz	11074622	
Inert Loop S-395 220V 60Hz	11075174	

	Order no.	Image
Inert Loop S-395 240V 60Hz	11074623	
Inert gas adapter S-300, complete	11074499	
Trolley S-300	11074575	
Protective curtain right, complete	11071754	
Protective curtain left, complete	11071651	
Ultrasonic Package S-300	11074994	
Peristaltic pump external Second peristaltic pump for three fluid nozzle, nozzle cooling or shorter distance between pump and nozzle.	11070786	
Inlet filter, complete Protects the sample from particles of the environmental drying air. Only for open mode.	011235	
Replacement filter with seal	011238	

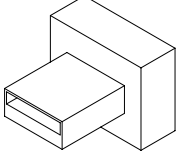
	Order no.	Image
Spray cylinder chrome steel, complete	11064367	
Adapter USB-Wi-Fi/Bluetooth	11072500	
Oil-free compressor, 230V 50Hz	027907	
Oil-free compressor, 230V 60Hz	11055737	
Compressed air maintenance unit	004366	

## Glassware

### Glass assemblies

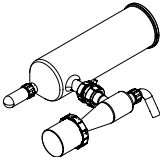
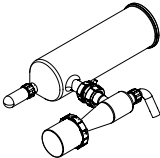
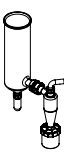
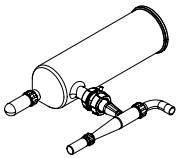
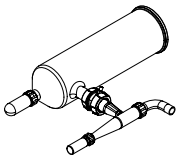
	Order no.	Image
Glass assembly S-300, complete	11071071	
Glass assembly S-300 brown, complete	11073658	
Glass assembly corrosive S-300, complete	11071420	
Glass assembly S-300 HP cyclone, complete	11074494	
Glass assembly S-300 HP cyclone brown, complete	11074495	

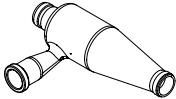
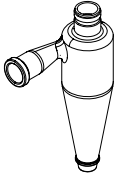

## Cyclones

	Order no.	Image
Standard cyclone	11071060	
Cyclone brown	11073659	
Standard cyclone with collection vessel, complete	11073661	

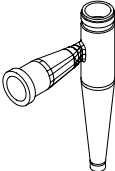
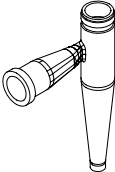
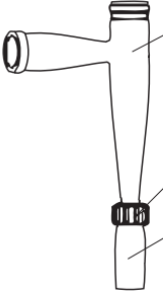
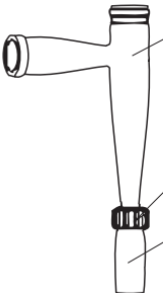
## High performance cyclones

	Order no.	Image
High performance cyclone	046368	
High performance cyclone brown	11056879	
High performance cyclone, complete	11074500	
High performance cyclone brown, complete	11074496	

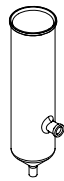
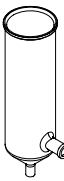
## Spray cylinder

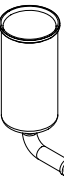
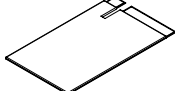
	Order no.	Image
Spray cylinder	044673	
Spray cylinder brown	044726	
Spray cylinder vertical outlet	044697	
Spray cylinder vertical outlet, brown	044728	
Cylinder insulation	040058	

## Collection vessels

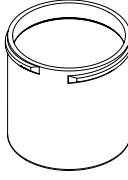
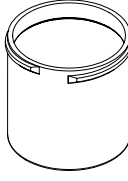
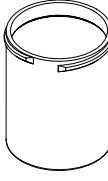
	Order no.	Image
Product collection vessel	044678	
Product collection vessel brown	044727	
Large Product collection vessel 1.1L	11056990	







	Order no.	Image
Plastic closure for product collection vessel	046358	

## HP collection vessels and accessories

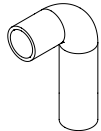
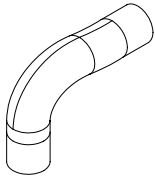
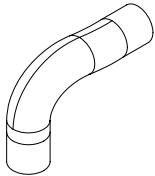
	Order no.	Image
Small product collection vessel for HP cyclone	046367	
Small product collection vessel for HP cyclone brown	11056878	
Large product collection vessel for HP cyclone, complete	11056899	
Cover for large collection vessel HP cyclone	11056901	
Screw cap SVL 30	005223	
Flange screw coupling	034139	

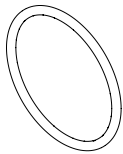
## Other glassware related spare parts

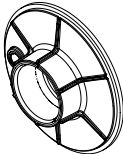
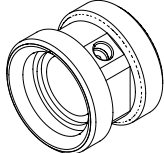
	Order no.	Image
Angle tube	11070485	

	Order no.	Image
Angle tube brown	11073660	
Angle tube for HP cyclone	11073621	
Angle tube for HP cyclone brown	11074322	
Cap nut 130	11070711	
O-ring 104 x 6.99 FKM 70	11071062	
Cover product vessel at cyclone	11072625	
Cover product vessel corrosive	11071425	
Coupling flange	11073537	
Coupling flange corrosive	11071421	



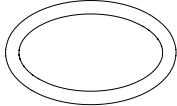
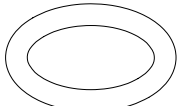
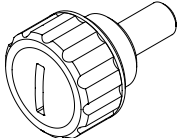
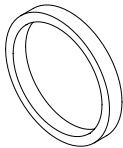
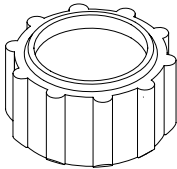
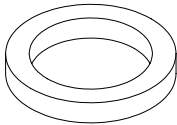
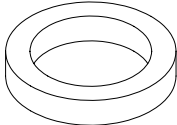
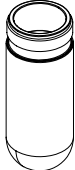

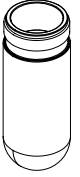
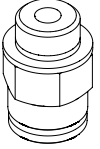
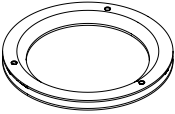
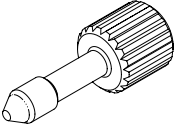
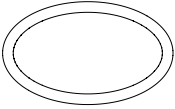



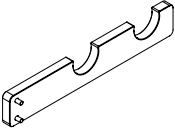
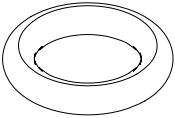

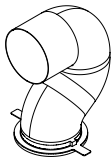
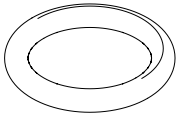
	Order no.	Image
Set flange screw coupling 1 pcs.	11074579	
O-ring FKM for screw coupling	001535	
Tension spring	032017	
Knurled handle with recess	11071059	
Gasket SVL 42.00 x 35.00 mm	11071061	
Cap nut SVL 42	003551	
Silicone seal SVL 42	040674	
PTFE Seal SVL 42	003575	
Separation flask	004188	

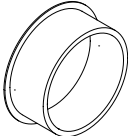
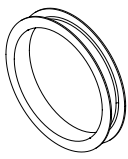
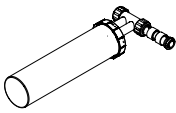
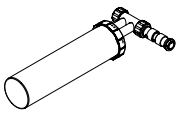
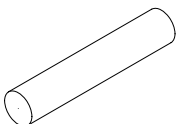
	Order no.	Image
Separation flask brown	004343	
Quick connector Nozzle Ø6	11071105	
Spray cylinder holder	044710	
Screw for spray cyclinder holder	044712	
O-ring to spray cylinder	044711	

## Spare parts

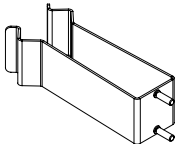
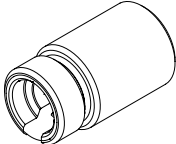
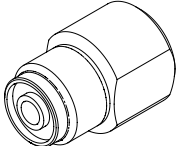
	Order no.	Image
Set O-ring Plastiperfl. S-300	11074501	
Tube holder	11071708	
O-ring Ø 5.00x1.50 Plastiperfl.	11074587	

	Order no.	Image
Ventilation hose aspirator, complete	11071064	
O-ring Ø 27.94x5.33 FKM 75	11071073	
Clamping lever M4	11071171	
Cover cap Ø 25.4	11071194	
Gasket SVL 42x35 PTFE	11071325	
Outlet filter, complete	11071410	
Outlet filter corrosive, complete	11071411	
PTFE membrane filter with clamp	11075115	
Polyester filter bags (6 units)	035004	
Quick release clamp	11071080	

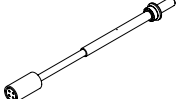
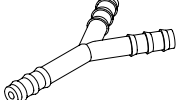
	Order no.	Image
Filter holder grounded	11073770	
Fixing nut T-sensor	11073019	
Adapter T-sensor outlet	11073020	
Outlet T-sensor	11072981	
Product T-sensor	11072982	
Outlet T-sensor corrosive	11071406	
Product T-sensor corrosive	11071407	
Closing pin	11071611	
Silicon tube D2/4 (per m)	004138	
Y-piece connector	046304	

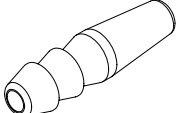
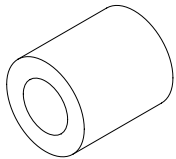
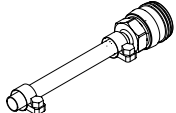
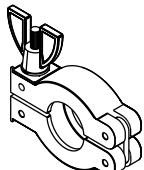
	Order no.	Image
Metal tube connector	004251	
Silicone tube for nozzle cooling, 4 m	004139	
Compressed gas hose, complete	11073584	
Tygon tube MH2375 transparent (per m)	046314	
Tygon tube F 4040 A yellow (per m)	046315	
Vacuum clamp KF 25	11063662	

## Hoses and tubes

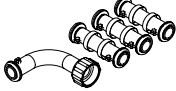
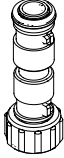
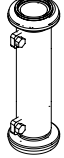
	Order no.	Image
Set hose drying gas TPR	11071431	
Set tube PTFE	11072713	
Hose filter conf.	11071057	
Tube Inert Loop PTFE conf.	11071602	

	Order no.	Image
Hose Inert Loop TPR conf.	11071076	
Tube Dehumidifier TPR conf.	11074039	
Tube filter FEP conf. corr.	11072988	
Hose TPR 0.7 m conf.	11071051	
Hose TPR 1.0 m conf.	11071053	
Hose PTFE 0.7 m conf.	11071054	
Hose PTFE 1.0 m conf.	11071056	
Hose PTFE 0.7 m conf. coated	11071606	
Hose PTFE 1.0 m conf. coated	11071608	

## Documents

	Order no.
Set IQ/OQ S-300 en	11074567
Repeating OQ S-300 en	11074568