

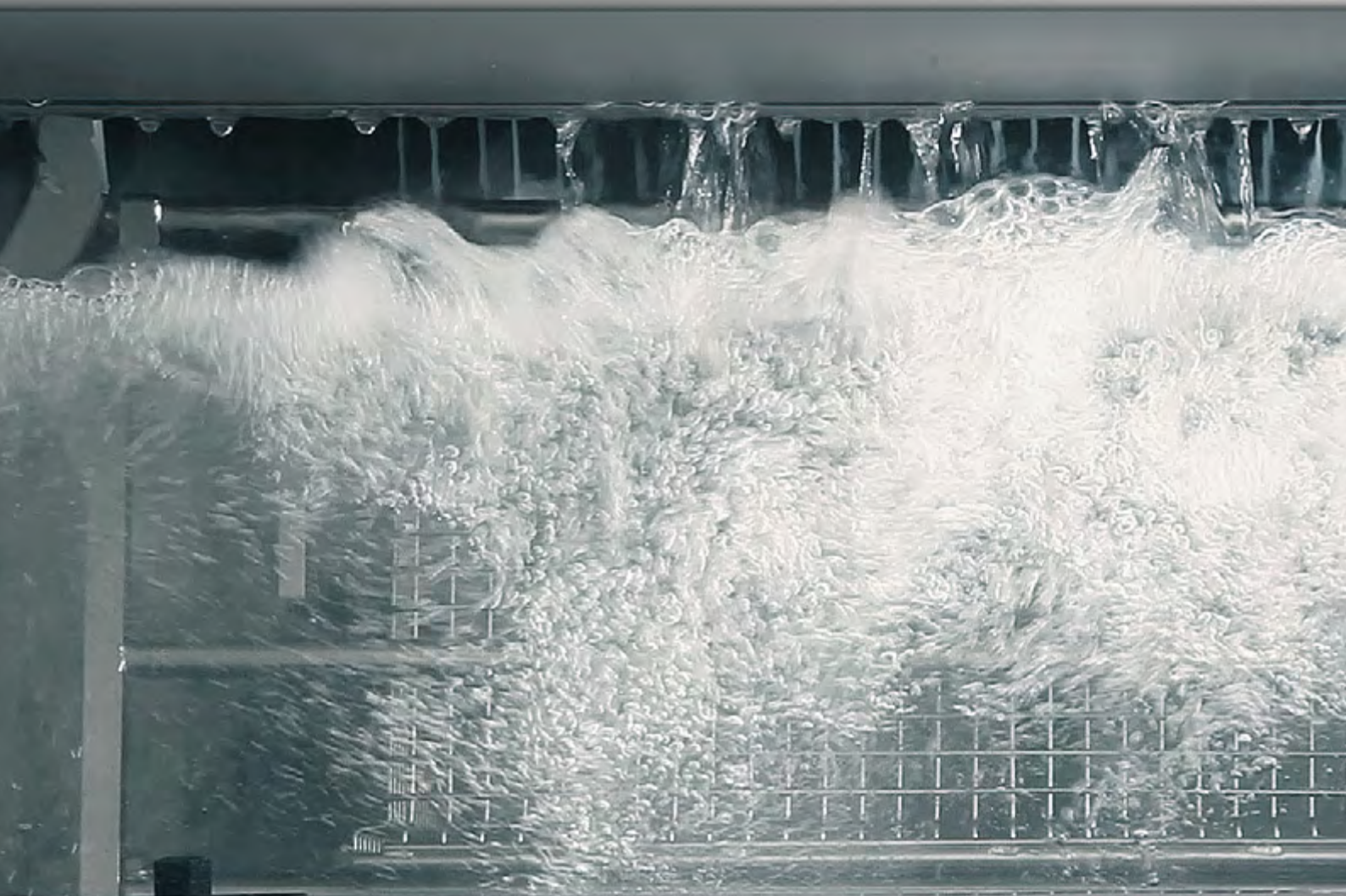

Parts Cleaning. Systems and Solutions.

Clean operations.



Our complete range of products
Machines · Technologies · Service



Table of contents

MAFAC in Alpirsbach04
Effective and gentle cleaning06
Innovative solutions, thoroughly tested07
Dynamic cleaning and drying08
Motion in perfection.10
VAP – Vacuum Activated Purification12
Overview of machine models13
Intuitive programming und operation14
OUR MACHINES	
MAFAC PURA16
MAFAC KEA20
MAFAC ELBA24
MAFAC JAVA28
MAFAC PALMA32
MAFAC PALMA XL36
MAFAC MALTA.40
MAFAC CONTINUO44
MAFAC system solutions46
Energy-efficient cleanliness48
Saving energy50
Further accessories52
Service plus54

MAFAC in Alpirsbach

Ensuring cleanliness worldwide





MAFAC is one of the international leaders in the field of aqueous parts cleaning. The family-owned company was founded in 1968 and today, with over 100 employees at its Alpirsbach headquarters, manufactures a wide range of compact parts cleaning systems featuring a large variety of appli-

cations and high product quality, ease of use, and resource-efficient technology. Our company is known for its unique, patented cleaning process of counter- or corotation of spray and basket receptacle system. Thanks to the continuous new and further development of our machine techno-

logies we keep improving the cleaning quality of our machines and achieving top performance standards. This is based on our extensive research and development work with renowned universities.

Below you will find an overview of the areas of application for aqueous parts cleaning, our machine portfolio, our service offers, as well as our comprehensive range of accessories for reliable, energy-efficient parts cleaning.



Managing partners Armand Oostendorp (on the left) and Stefan Schaal (on the right)

 FOR MORE INFORMATION:



Image film:
<https://www.mafac.de/go/Film>

Download brochure:
<https://www.mafac.de/go/productrange>

Effective and gentle cleaning

Aqueous media are environmentally sound



Numerous different methods are available for industrial parts cleaning, each having its justification depending on the individual cleanliness requirements, component properties, material, and contamination. At MAFAC we have specialised on kinematic aqueous parts cleaning with single-chamber machines.

Aqueous cleaning is an environmentally friendly method. Due to the various adjustable parameters in mechanics, chemistry, temperature and time, very good and reliable cleaning results can be achieved.

- Environmentally friendly method
- Excellent cleaning results due to a clever combination of process engineering, temperature, treatment time and chemical agents
- Long service life of the cleaning medium
- Very small amounts of chemical cleaning agents are added



The tables to the right give you an overview of the applications aqueous cleaning is suitable for.

For what type of contamination is aqueous cleaning suitable?	
Contamination	Suitability
inorganic, polar (salts)	◆ ◆ ◆
inorganic, non-polar (chips, dust)	◆ ◆ ◆
organic, non-polar (oils, fats)	◆ ◆
organic, polar (wood resin)	◆

What cleaning quality can be achieved with aqueous cleaning?	
Cleaning quality	Suitability
particle-free	◆ ◆ ◆
chip-free	◆ ◆ ◆
surface tension	◆ ◆ ◆
stain-free	◆ ◆
fat-free	◆ ◆

For what type of material is aqueous cleaning suitable?	
Material	Suitability
stainless steel	◆ ◆ ◆
steel	◆ ◆ ◆
aluminium	◆ ◆ ◆
brass	◆ ◆ ◆
copper	◆ ◆ ◆
titanium	◆ ◆ ◆
plastics	◆ ◆ ◆
sintered metals	◆ ◆

Key of symbols:

◆ ◆ ◆ very good ◆ ◆ good ◆ moderate

Innovative solutions, tried and tested

Flexible standard models with numerous options

Our compact single-chamber machines allow cleaning, rinsing and drying in only one machine. They are available as standardised basic machines which have been tried and tested time and again in daily use and can be adapted to your individual requirements thanks to numerous options.

The advantages at a glance:

- Effective cleaning and drying thanks to the patented rotation principle of basket and nozzle system. Compared to a rigid system, 20 % of energy costs can already be saved at this stage.
- High reliability and process stability
- Proven through use in multiple practical applications
- Intuitive operation and control
- Integrated extraction and condensation for decentral use
- Effective coalescing oil separator for long useful bath life
- ultrafine filtration systems for minimised particle content

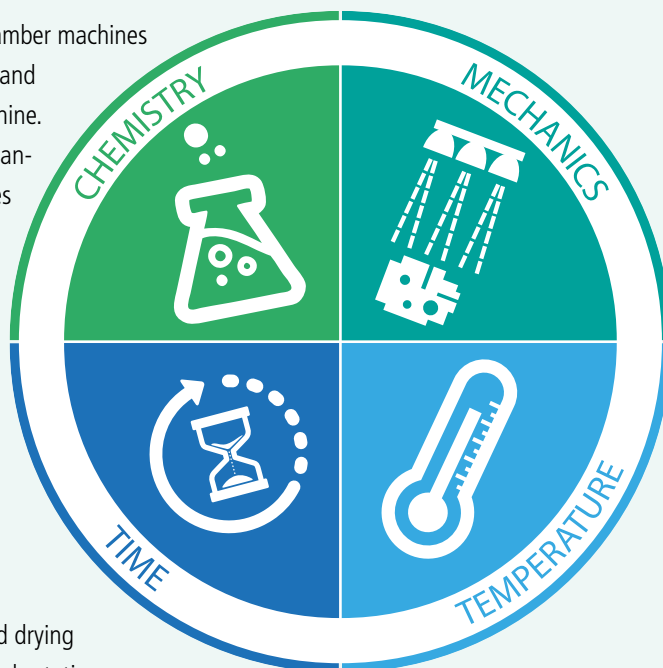

- Controlled bath heating for a continuous process
- Minimisation of media carry-over through blowing out the media distributor and the nozzle system
- Cascaded baths
- Large bath volumes for long useful bath life
- Reinforced pump systems
- Differential pressure monitoring of ultrafine filters for filter monitoring
- Targeted cleaning and drying of surfaces which are difficult to access
- Vector-kinematic cleaning and drying for increasing contact in a wide variety of angles
- Ultra-sound cleaning with double-sided parabolic reflector
- Rotatable ultrasound for optimal impact also in rocking mode
- High availability of spare parts due to high degree of standardisation
- Fast and pro-active service

FOR MORE INFORMATION:

<https://www.mafac.de/go/users>



Dynamic cleaning and drying

Patented kinematic process -
Intelligent, efficient cleaning and drying

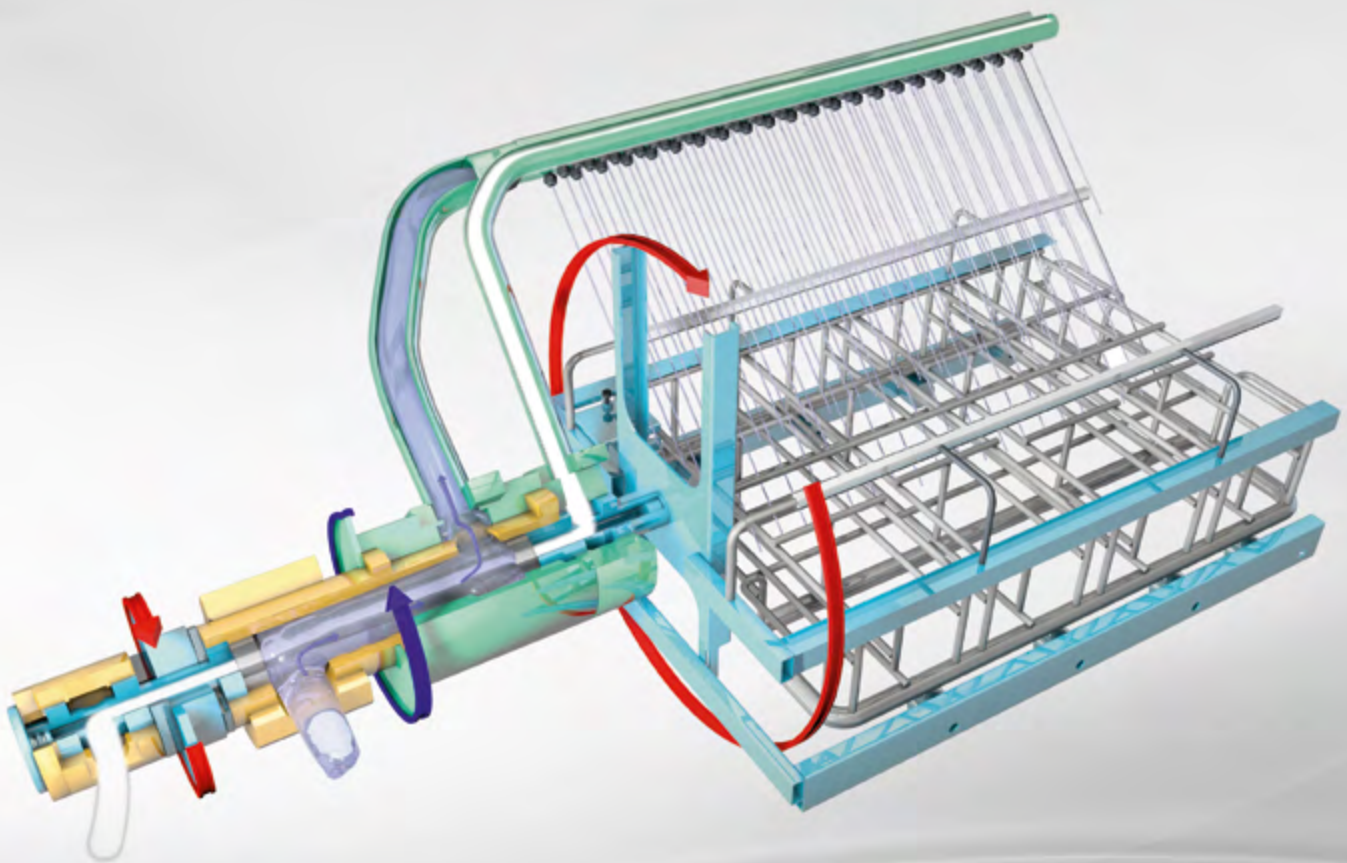



Design inspired by relative movement

All MAFAC parts cleaning machines feature the patented process technology of counter- or co-rotation of spray system and basket receptacle system, which is unique worldwide. This innovative technology is the basis for both safe and efficient process solutions in industrial parts cleaning. It is based on the simple insight that every cleaning process works better if it involves movement.

Efficient cleaning and drying is ensured because the relative movement between the basket receptacle system, which can rotate, rock, or stand, and the spray system, which can counter- or co-rotate in relation to the

basket receptacle system, can be adjusted independently and individually.

In the course of intensive research and development work, this kinematic principle was also transferred to other technologies, so that we were able to achieve a distinct increase in the performance of our drying and ultrasonic systems. The result: Critical component geometries can be systematically targeted, gently cleaned and reliably dried.

Energetic added value

With the patented rotation principle it is possible to kill two birds with one stone:

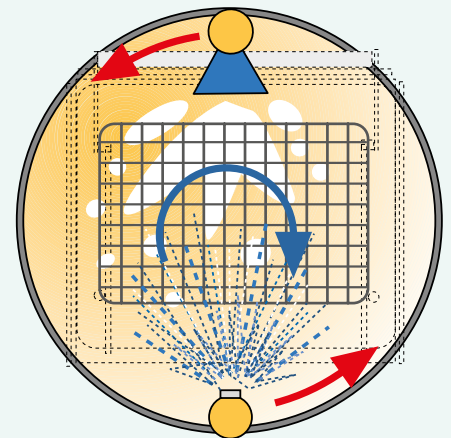

Apart from cleaning-specific advantages, it demonstrably leads to energy savings of up to 20 % percent.

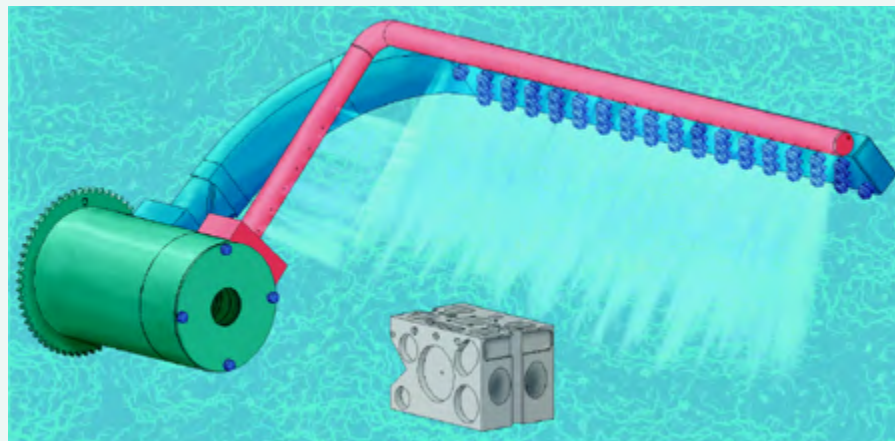

- HIGHLIGHTS:**
- Patented process engineering
 - Rotation of basket and spray system
 - Rotation of drying systems
 - Rotation of ultrasonic system
 - Energy savings of up to 20 %
 - "Made in Germany"

Motion in perfection

Precise cleaning with innovative technology

Efficient cleaning of complex geometries

Metalworking companies are often faced with the challenge of effectively and reproducibly cleaning components with complex contours within a short period of time. As one of the leading manufacturers of innovative cleaning machines we aim at offering you high-quality and safe solutions for increasingly stricter cleanliness guidelines. To this end, we keep developing our patented process so that you can meet even higher requirements with our products.

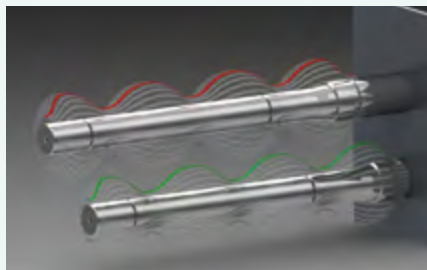

Rotatable ultrasound - Cleaning delicate workpieces gently and thoroughly

MAFAC ultrasonic technology combines ultrasound with kinematics, which means that the ultrasonic devices rotate around the basket receptacle system. That way, the sonic waves are better distributed within

the chamber and the components are more intensively exposed to ultrasound from all sides. By accurately specifying the angle position you can target the position of the components and the correlative sonic source directly. MAFAC ultrasonic technology helps you to clean sensitive components both effectively and gently as you can reach critical component geometries or heavy contamination as needed and intensify or reduce the sonic input as required.

FOR MORE INFORMATION:

https://www.mafac.de/go/Ultra_EN

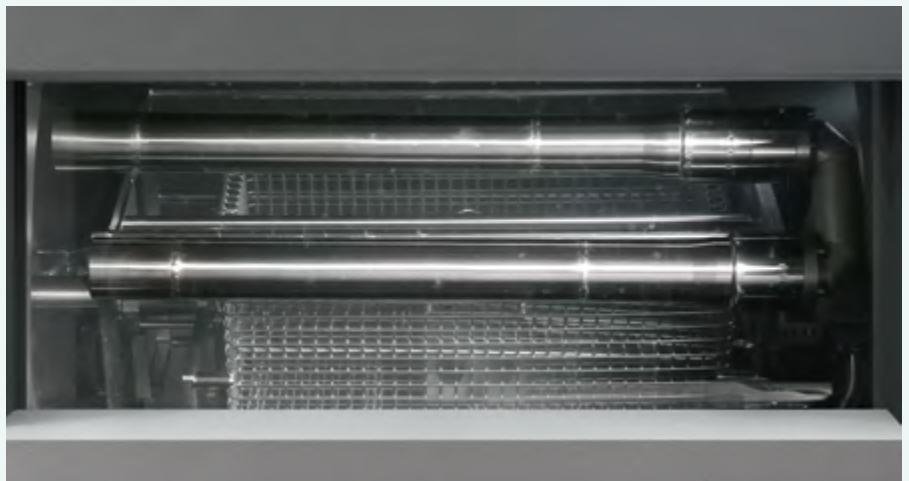
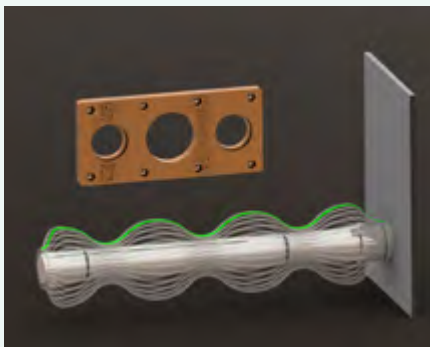



Direct cleaning and drying - Differentiated impact

Workpieces with geometries and surfaces that can be reached in different ways are more time-consuming and energy-intensive to clean than parts with a homogeneous design. Until contamination is sufficiently removed from the hidden internal contours, easily accessible parts are usually "over-cleaned", using up valuable resources. The MAFAC method for targeted cleaning and drying allows you the differentiated processing of these workpieces. In combination with the counterrotation of basket receptacle and spray system, it causes a high degree of turbulence in the inflow and throughflow of internal contours. The heart of the new technology is the workpiece positioning system (WPS), in which integrated media nozzles ensure the targeted impact on the functional geometries.



Flat secondary geometries continue to be treated comprehensively.

FOR MORE INFORMATION:

<https://www.mafac.de/go/targeted>

https://www.mafac.de/go/target_EN

https://www.mafac.de/go/target_mov

Vector kinematics - a new dimension of dynamic cleaning

MAFAC vector kinematics ensures even more movement in parts cleaning and drying. In contrast to the process in a rigid nozzle system, the workpieces are not hit centrally but from a number of different angles. This is based on the rocking motion performed by the nozzle tube about its own axis through 35° to either side. The basket receptacle system rotates synchronously at an optimally adapted speed. This coordinated interaction of nozzle tube and basket movements leads to a targeted and, depending on the shape of the part, up to 60 % higher impact on the component surfaces. The large number of different angles of impact leads to significantly fewer spray shadows so that excessive cleaning of easily accessible component regions, using up valuable resources, is

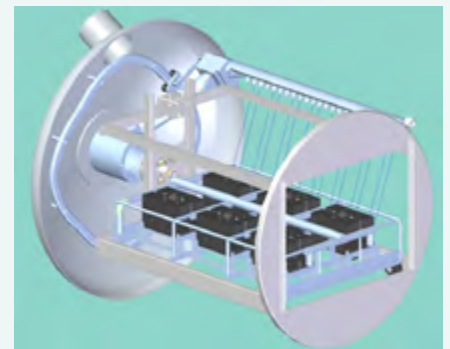

avoided. Thanks to the high angle variance, you can process a large variety of highly different workpiece batches and solve many cleaning tasks. This gives you more flexibility to cover a wider range of parts.

FOR MORE INFORMATION:

<https://www.mafac.de/go/Vector>

https://www.mafac.de/go/Vector_EN

https://www.mafac.de/go/Vector_interview

https://www.mafac.de/go/Eckerle_EN

VAP – Vacuum Activated Purification

cleaning process for capillary parts geometries

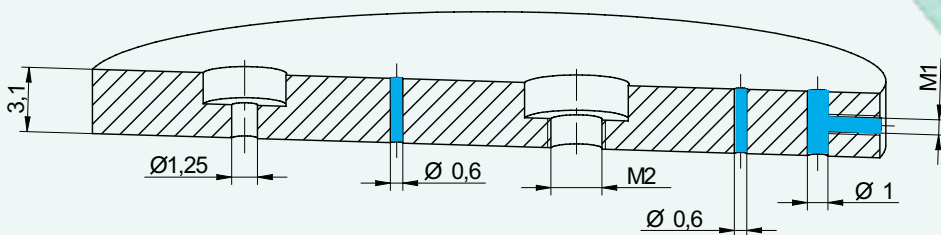

Components with narrow capillary structures and angled ducts are a great challenge in parts cleaning – especially if high demands on cleanliness have to be met at increasing costs. With the MAFAC Vacuum Activated Purification (VAP), we offer a process for these applications which reliably and economically cleans even deep drilled holes with narrow cross sections on an aqueous basis.

The VAP ensures an optimum exchange of media for cleaning critical geometries and thus improved dirt removal. To this end, the MAFAC VAP works with purposefully introduced, controlled alternating pressures that increase the cleaning effect of spray or

spray-flood cleaning. During this process, the cleaning chamber with the material to be cleaned is first evacuated and then flooded to a pre-defined level. The cleaning agent penetrates into the blind holes and capillaries where it dissolves the dirt particles present there. As a next step, controlled alternating pressure is generated in the cleaning chamber. The regularly alternating pressure conditions produce a media exchange as well as cavity effects, which cause the dirt to be removed effectively but, in a material-friendly manner.

In combination with the patented MAFAC process technology of counter or co-rotating

basket receptacle and spraying system, the new process achieves significantly improved cleanliness in terms of particles for parts exhibiting a capillary and complex structure. The process can be programmed in a very flexible manner and tailored to the respective requirements. MAFAC Vacuum Activated Purification is suited for virtually any application, but is particularly suitable for medical engineering, pharmaceuticals, the optical industry, electrical engineering and the laser industry. It is even possible to perform cleaning tasks on workpieces originating from 3D printing or for electromobility.

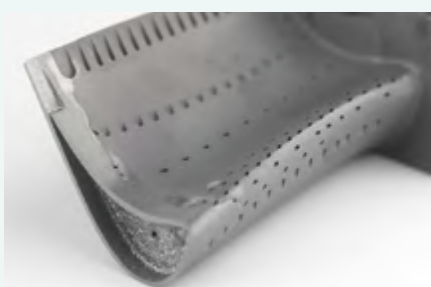

Overview of machine models



CLEANING MACHINE	MAFAC PURA	MAFAC KEA	MAFAC ELBA	MAFAC JAVA	MAFAC PALMA	MAFAC PALMA XL	MAFAC MALTA
APPLICATION							
Intermediate cleaning	•	•	•				
Sophisticated cleaning		•	•	•	•	•	•
High-end cleaning				•	•	•	•
CLEANING							
Spray cleaning	•	•	•	•	•	•	•
Flood cleaning				•	•	•	•
Vector kinematics				•	•		
VAP				•	•		•
Number of baths	1	1	2	1 – 2	2 – 3	2 – 3	2 – 3
Patented rotation of basket and spray system	•	•	•	•	•	•	•
Filtration	•	•	•	•	•	•	•
Oil separation	•	•	•	•	•	•	•
Stationary ultrasonic cleaning				•	•	•	
Rotating ultrasonic cleaning							•
Fresh water rinse		•	•	•	•	•	•
DRYING							
Rotating impulse blowing system		•	•	•	•	•	•
Stationary impulse blowing system	•						
Stationary hot-air drying system		•	•				
Rotating hot-air drying system				•	•	•	•
Targeted drying				•	•		
Vacuum drying				•	•	•	•
DIMENSIONS							
Dimensions in mm (D x W x H)	1150 x 950 x 1600	1350 x 1050 x 2050	1950 x 1500 x 2000	2150 x 1600 x 2250	2400 x 2350 x 2250	3800 x 2400 x 2400	2250 x 2250 x 2200
Standard basket size (L x W x H)	471 x 321 x 200	600 x 400 x 288	600 x 400 x 288	600 x 400 x 288	600 x 400 x 288	800 x 600 x 400	471 x 321 x 200
Alternative basket size (L x W x H)			660 x 480 x 338	660 x 480 x 338	660 x 480 x 338		
Further basket sizes	----- on request -----						
Weight per batch in kg	50	100	100	100/250	100/250	250	75
Load capacity increase	----- on request -----						

Intuitive programming and operation

User interface of the future: MAVIATIC plus

User interface of the future: MAVIATIC plus

With the innovative MAVIATIC plus input panel you have everything under control! Thanks to the clearly organised menu structure, you will quickly find your way around and can operate your cleaning machine with ease and simplicity. Easily identifiable symbols and graphic input

elements guide you through the program without requiring any further explanations and, together with clearly defined user rights, ensure a high level of operating safety.

Programming is also quick and easy: preconfigured programs can be adapted to individual requirements with the aid of a programming assistant. A further safety

aspect is provided by the intelligent input fields of the user interface: They continuously check your input values and correct them automatically if necessary. In addition, current measurement and status displays provide information about the current machine status at all times. Together with the colour-coded display of the program sequence, this ensures continuous process tracking and simple fault diagnosis. Any information relevant for service and photographic position finding can be obtained directly by simply clicking on the unit symbols in the program, allowing quick maintenance.



HIGHLIGHTS:

Intuitively, preconfigured programs

Programming assistant for simple, individual adaptation

High programming and operating reliability

Graphical process visualisation

Display of current measured values and status

Process data archiving

Quick fault diagnosis

Quick and informative system overview



In addition, MAVIATIC plus offers extensive options for natural data networking and process data archiving and analysis. It is also possible to connect additional measuring instruments or to Industry 4.0. The integration of additional documents such as drawings, process data sheets, measurement diagrams or cleaner information completes the system's user-friendliness.

All MAFAC cleaning machines except the MAFAC PURA are equipped with the MAVIATIC plus control system with the "basic" software package. Two additional software packages "comfort" and "connect" are optionally available.

MAVIATIC plus basic

the standard programme with high operating convenience. It is equipped with highlights such as enhanced process overview and next step display, display of the remaining program running time, flow chart with EIS designation, maintenance module basic with service menu and five standard protocols.

MAVIATIC plus comfort

for added operating convenience. The retrievable batch record provides a comprehensive overview and the extension to 50 process steps permits a greater variety of applications. The integrated clock timer provides for increased convenience and simultaneous energy savings.

MAVIATIC plus connect

for external access to the cleaning machine. The software package permits the smooth networking and data transmission so that operating modes and programs can be reliably selected.



MAVIATIC PLUS AT A GLANCE:

Programme selection with hand scanner

Operating language automatically in German and English

Remote maintenance enables our service department to connect to the operating panel and support the customer if necessary.

Basis SPS Siemens S7 1500 and HMI SIMATIC 7"

Timer and remote maintenance available separately or as a package

MAFAC PURA

The entry-level model for fast spray cleaning





The compact spray cleaning machine with single bath technology is designed as an allround parts washer for decentralised use. Accordingly, its design and programming have been reduced to the essentials. The patented and proven MAFAC process technology with counter-rotating basket-nozzle rotation is the indispensable centrepiece of the machine. As a result, the MAFAC PURA works efficiently, ensuring the safe and effective cleaning of the component surfaces. The parts are dried via a hotair impulse blower system.

High-quality technology for a small budget

In addition to its powerful technology, this machine impresses with its functionality and simplicity. The MAFAC PURA standard



selection program has been designed to facilitate easy operation by anyone. This enables customers to start up the system on their own. If needed, the MAFAC telephone support or a service engineer are available for assistance. The equipment also supports uncomplicated handling of the machine in other ways: The starter kit with basket and cleaner makes it easy to get started. The small basket size allows small batches to be processed, or the fast intermediate and final cleaning of individual workpieces. An optional coalescing oil separator and high-quality main-stream filtration ensure a long and stable useful bath life. Another benefit: The voltage range of the machine is suitable for worldwide use. The modern machine design, where MAFAC focuses on the use of new materials, presents a visually appealing

appearance within the production facilities. The MAFAC PURA completes the product range and specifically addresses those who are entering the aqueous parts cleaning market, have little experience or work within a tight budget.

Available from stock

When designing the MAFAC PURA, it was decided to apply the "machine-to-go principle" for the first time. The MAFAC PURA is built in batches of 10 and is therefore immediately available from stock. The purchase is not preceded by test cleaning. For the simple applications for which the MAFAC PURA has been designed, we rely on our experience. These were all standardised and incorporated in product development, so that no individual adjustments are necessary, allowing "plug and play" for the user.

MAFAC PURA

Standard features and options

Standard features:

- Patented rotating, multi-sided spray system with counter-rotating basket receptacle system
- Compact design with minimum space requirements
- Window in the cleaning chamber allows observation of the cleaning process
- Hinged door as a functional loading and unloading platform
- Large-capacity holding tank to ensure long useful life of the process water
- Standard baskets can be used (471L x 321W x 200H mm or 521L x 321W x 200H mm)
- Mechanical ultrafine filtration in the main stream with filter bag
- Removable basket filter for collecting dirt particles in the return flow from the cleaning process
- Stationary hot air impulse blowing system
- Bath heating system with digital temperature control and limitation
- Steam extraction with condensation and mist separator
- Automatic medium level control
- Simple and convenient operation via the integrated Siemens K300 text display
- Plug and Play: available at short notice and immediately ready for use
- Voltage range designed for worldwide use

Options:

- Powerful coalescing oil separator (45 l) with maximum monitoring of the oil collection tank

Accessories:

- Initial equipment with cleaning agent and basket
- Collecting tray in accordance with Cl. 19 German Water Management Act (WHG) including oil level sensor
- Drip tray
- Draining pump
- Automatic chemicals dosing



Dimensions:

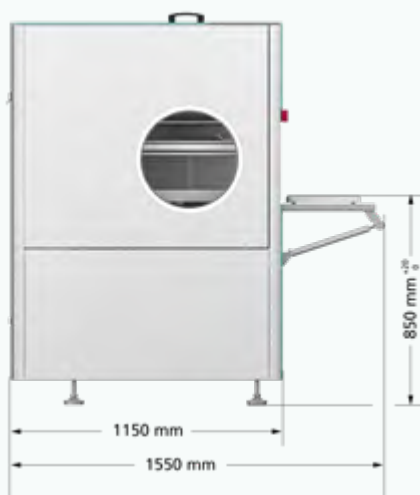

FOR MORE INFORMATION:

https://www.mafac.de/go/PURA_EN

https://www.mafac.de/go/PURA_mov

Spraying pressure pump, standard version			Return filtration		Main stream ultra-fine filtration	
Flow volume	Pressure	Output	Fineness	Surface area	Fineness	Surface area
Cleaning process holding tank 1:						
at 380 – 460 V / 50 Hz approx. 100 l/min	at 380 – 460 V / 50 Hz approx. 2.5 bar	2,2 kW	150 µm	0,2 m ²	100 µm	0,16 m ²
at 380 – 460 V / 60 Hz approx. 130 l/min	at 380 – 460 V / 60 Hz approx. 4 bar	2,2 kW	150 µm	0,2 m ²	100 µm	0,16 m ²
Holding tank:			Content	Heating time	Temperature	Heating Capacity
			295 litres	approx. 2 h	max. 75°C	10 kW
Connections:			Electronics: 380 – 460 V, 3~/PE, 50 Hz, 380 – 460 V, 3~/PE, 60 Hz			
			Compressed air : Rp ¾ inch, 5 – 8 bar			
			Fresh water: Rp ¾ inch, 0,5 – 10 bar			
			Waste water: Rp 1½ inch			
			Exhaust air: 113 x 105 mm			
Exhaust extraction/condensation:			Mean volumetric flow rate: 600 m ³ /h			
Drying systems:			Impulse blowing system: 3 – 6 bar, < 45°C			
Weights:			Batch: max. 50 kg			
			Machine without medium: 500 kg			
			Machine with medium: 800 kg			
			Machine with medium and oil separator: 850 kg			
Machine colour:			Light grey, RAL 7035			
			Light green, similar to RAL 6027			
Technical details for further features and options are available on request.						



Optional coalescing oil separator

MAFAC KEA

Compact and powerful space saver





additional fine filter can be installed to remove even the smallest particles.

Compact, space-saving and quiet

Despite its space-saving design, the MAFAC KEA holding tank holds a considerable volume of 320 litres, ensuring a long useful bath life. Another user-friendly aspect is its reduced noise level. With noise levels of only approx. 71dB(A), MAFAC KEA is exceptionally quiet.



Taking up only a minimum of space, the MAFAC KEA offers high-end technology for a wide range of applications. Discover the numerous benefits of this compact single-bath cleaning system in daily use.

The MAFAC KEA provides reliable cleaning results using MAFAC's patented spray cleaning process with counter- or corotation of the holding basket and spraying frame. The special design of the spraying system including flat spray nozzles and full jet nozzles

allows for impulsed or selective cleaning of components as well as the cleaning of larger surfaces. Parts can be dried by means of a rotating hot air impulse blowing system and a stationary hot air drying system.

Intelligent bath maintenance

Long and reliable bath life is ensured by a coalescing oil separation system, which utilises a floating surface suction device within the holding tank. Optionally, an

MAFAC KEA

Standard features and options

Standard features:

- Patented rotating, multi-sided spray system with counter-rotating basket receptacle system
- Front loading with hinged door
- Hinged door as a functional loading and unloading platform
- Large holding tank for long useful bath life
- Standard Euro baskets can be used (600L X 400B 288H mm)
- Removable basket filter for collecting dirt particles in the return flow from the cleaning process
- Bath heating system with digital temperature control and limitation
- Steam extraction with condensation and mist separator
- Powerful coalescing oil separator with maximum monitoring of the oil collection tank
- Automatic medium level control
- Thermal insulation of the holding tank
- Water contact components made of stainless steel / plastic
- Easy-to-use MAFAC MAVIATIC plus touch panel

Options:

- Rotating hot air impulse blowing system
- Stationary hot air drying system
- Mechanical main stream ultrafine filtration with filter bags or filter candles
- Enhanced pump system
- Speed control for basket rotation including rocking motion
- Program package for machine pre-heating and media treatment
- Window in the cleaning chamber allows observation of the cleaning process
- Complete demineralising unit
- Automatic chemicals dosing
- Draining pump
- Collecting tray in accordance with Cl. 19 German Water Management Act (WHG) including oil level sensor
- Automatic vertical sliding door
- Charging trolley
- Manual roller conveyor
- Automatic transfer system
- Modem for remote maintenance of the control system
- Fresh water rinsing system
- Heat exchange module MAFAC HEAT.X
- Customised colours
- Larger versions and further options on request



Dimensions:



Height with option
"automatic vertical sliding door": 2500 mm

FOR MORE INFORMATION:

https://www.mafac.de/go/KEA_EN

https://www.mafac.de/go/KEA_mov

https://www.mafac.de/go/Medikomp_EN

https://www.mafac.de/go/Rich_EN

Spraying pressure pump, standard version			Return filtration		Main stream ultra-fine filtration	
Flow volume	Pressure	Output	Fineness	Surface area	Fineness	Surface area
Cleaning process holding tank 1:						
200 l/min.	3,5 bar	3 kW	150 µm	0,5 m ²	100 µm	1x 0,15 m ²
Holding tank:			Content	Heating time	Temperature	Heating Capacity
			320 litres	approx. 2 h	max. 75°C	10 kW
Connections:			Electronics: 400 V, 3 Ph, 50 Hz			
			Compressed air : Rp ¾ inch, 5 – 8 bar			
			Fresh water: Rp ¾ inch, 0,5 – 10 bar			
			Waste water: Rp 1½ inch			
			Exhaust air: DN 104 mm			
Exhaust extraction/condensation:			Mean volumetric flow rate: 600 m ³ /h			
Drying systems:			Impulse blowing system: 3 – 5 bar, < 45°C			
			Hot air blowing system: 0,015 bar, max. 80°C, volume flow: 400 m ³ /h			
Weights:			Batch: max. 100 kg			
			Machine without medium: 480 kg			
			Machine with medium: 800 kg			
Machine colour:			Light grey, RAL 7035			
			Light green, RAL 6027			
Technical details for further features and options are available on request.						

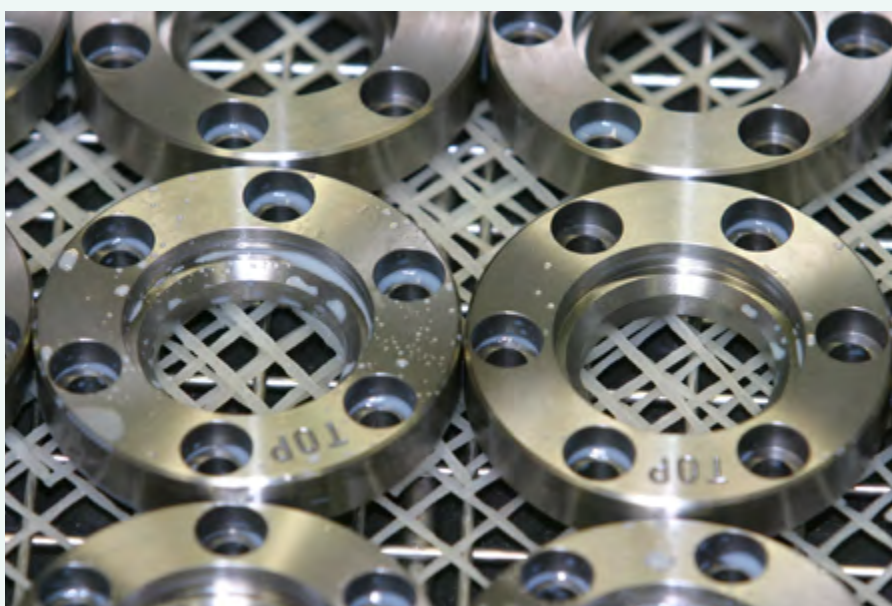

MAFAC ELBA

Versatile spray cleaning with a powerful double-bath technology





The MAFAC ELBA is your partner in mastering the diverse requirements of industrial parts cleaning. The double-bath system is compact, powerful, eco-friendly and can be used flexibly for a wide range of cleaning applications.

Proven worldwide in a variety of industries

MAFAC ELBA cleaning systems ensure clean results after machining processes worldwide. Companies in the automotive

industry and their suppliers, users in the electronics industry, turning shops and mechanical workshops benefit from the advantages provided by the MAFAC ELBA. Bulk materials, single workpieces, as well as batches of stainless steel, steel, cast iron, non-ferrous metals or even plastics are cleaned reliably.

Wide range of processes and programs

In combination with unique process technologies, the double-bath technology offers



flexible possibilities for efficient pre-treatment and post-treatment processes. Depending on requirements, the two baths are available, for example, for a main cleaning or rinsing cycle. By offering a rotating pulsed compressed air blast drying system or a stationary hot air drying system, MAFAC provides for high-quality options in drying technology meeting customers' individual system requirements.



MAFAC ELBA

Standard features and options

Standard features:

- Patented rotating, multi-sided spray system with counter-rotating basket receptacle system
- Hinged door as a functional loading and unloading platform
- Spray cleaning and rinsing in one machine
- Window in the cleaning chamber allows observation of the cleaning process
- Large holding tanks with cascaded design for a long useful bath life
- Standard Euro baskets can be used (600L X 400B 288H mm)
- Removable basket filter for collecting coarse dirt particles in the return flow from the cleaning/rinsing process
- Bath heating system with digital temperature control and limitation
- Steam extraction with condensation and mist separator
- Powerful coalescing oil separator with maximum monitoring of the oil collection tank
- Automatic medium level control
- Thermal insulation of the holding tank
- Water contact components made of stainless steel / plastic
- Easy-to-use MAFAC MAVIATIC plus touch panel

Options:

- Rotating hot air impulse blowing system
- Stationary hot air drying system
- Working tank adaptation to 660L x 480H x 338W mm
- Mechanical main stream ultrafine filtration with filter bags or filter candles
- Speed control for basket rotation including rocking motion
- Speed control of nozzle rotation
- Program package for machine pre-heating and media treatment
- Complete demineralising unit
- Automatic chemicals dosing
- Draining pump
- Collecting tray in accordance with Cl. 19 German Water Management Act (WHG) including oil level sensor
- Automatic vertical sliding door
- Charging trolley
- Manual roller conveyor
- Automatic transfer system
- Modem for remote maintenance of the control system
- Frequency-controlled pump pressure
- Reinforced pump systems
- Rinse water treatment module
- Fresh water rinsing system
- Heat exchange module MAFAC HEAT.X
- Customised colours
- Larger versions and further options on request



Dimensions:

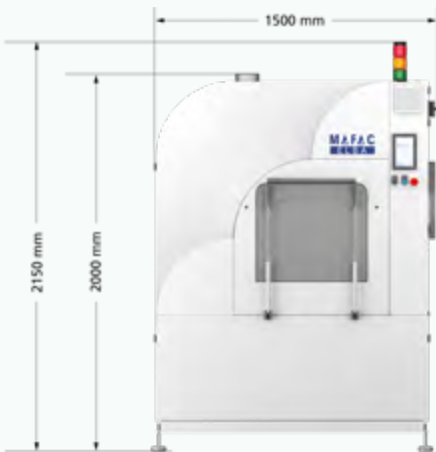

Height with option
"automatic vertical sliding door": 2150 mm

FOR MORE INFORMATION:

https://www.mafac.de/go/ELBA_EN

https://www.mafac.de/go/ELBA_mov

https://www.mafac.de/go/Hirschmann_EN

https://www.mafac.de/go/Geyer_EN

Spraying pressure pump, standard version			Return filtration		Main stream ultra-fine filtration	
Flow volume	Pressure	Output	Fineness	Surface area	Fineness	Surface area
Cleaning process holding tank 1:						
380 l/min	3,5 bar	4,0 kW	150 µm	0,56 m ²	100 µm	1 x 0,24 m ²
Rinsing process holding tank 2:						
210 l/min	1,8 bar	1,1 kW	150 µm	0,56 m ²	50 µm	1 x 0,24 m ²
Holding tanks:			Content	Heating time	Temperature	Heating Capacity
2-baths version	Holding tank 1, cleaning (including oil separator):		425 litres	approx. 2,0 h	max. 75°C	13 kW
	Holding tank 2, rinsing:		300 litres	approx. 1,5 h	max. 75°C	13 kW
Connections:			Electronics: 400 V, 3 Ph, 50 Hz			
			Compressed air : Rp ¾ inch, 5 – 8 bar			
			Fresh water: Rp ¾ inch, 0,5 – 10 bar			
			Waste water: Rp 1½ inch			
			Exhaust air: DN 120 mm			
Exhaust extraction/condensation:			Mean volumetric flow rate: 600 m ³ /h			
Drying systems:			Impulse blowing system: 3 – 6 bar, 45°C			
			Hot air blowing system: 0,012 bar, max. 80°C, volume flow: 420 m ³ /h			
Weights:			Batch: max. 100 kg			
			Machine without medium: 950 kg			
			Machine with medium: 1675 kg			
Machine colour:			Light grey, RAL 7035			
			Light green, RAL 6027			
Technical details for further features and options are available on request.						



MAFAC JAVA

Compact system for high-quality parts cleaning



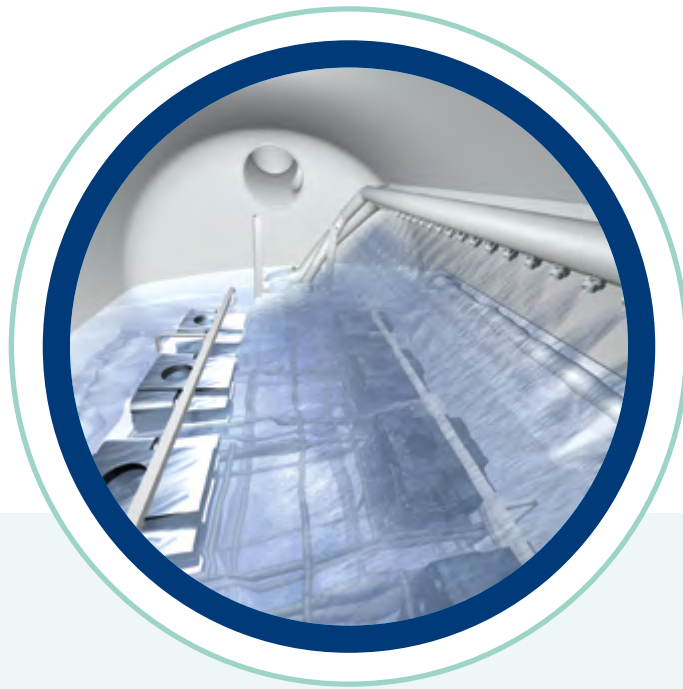

The MAFAC JAVA's standard sprayflood cleaning process ensures excellent cleaning results. During the cleaning phase, both the partial flooding of the cleaning chamber and the spray cleaning of the components are supported by the patented rotation of the cleaning and feeding system. Flood cleaning operations are especially effective for components with areas that cannot be reached directly by the cleaning detergent due to undercuts and hidden contours.

Reduced secondary process times, effective bath maintenance

With its extremely quick draining of the cleaning chamber, the MAFAC JAVA significantly contributes to the reduction of secondary process times. Effective bath maintenance is guaranteed by a standard coalescing oil separator. With 105 litres, it features an above-average capacity.

User-friendly touch panel control

The MAVIATIC plus visual display software, developed by MAFAC specialists, offers



excellent ease of use in a Windows "look & feel". It is based on a uniform touch screen control system.



MAFAC JAVA

Standard features and options

Standard features:

- Patented rotating, multi-sided spray system with counter-rotating basket receptacle system. A special nozzle arrangement ensures reliable cleaning results
- Front loading with vertical sliding door and loading table
- Spray cleaning and flood cleaning in one machine
- Large holding tanks with cascaded design for a long useful bath life
- Standard Euro baskets can be used (600L X 400B 288H mm)
- Removable basket filter for collecting coarse dirt particles in the return flow from the cleaning/rinsing process
- Separate bath heating system with digital temperature control and limitation
- Steam extraction with condensation and mist separator
- Powerful coalescing oil separator with maximum monitoring of the oil collection tank
- Automatic medium level control
- Thermal insulation of the holding tank
- Water contact components made of stainless steel / plastic
- Easy-to-use MAFAC MAVIATIC plus touch panel
- Floodable cleaning chamber

Options:

- Rotating hot air impulse blowing system
- Combined rotating hot air impulse blowing and hot air drying system
- Vacuum drying
- Additional spray process with holding tank 2 for rinsing
- Ultrasonic cleaning system incl. parabolic reflector for optimum efficiency of the ultrasonic waves
- Window in the cleaning chamber allows observation of the cleaning process
- Working tank adaptation to 660L x 480W x 338H mm
- Mechanical main stream ultrafine filtration with filter bags or filter candles

- Speed control for basket rotation including rocking motion
- Speed control of nozzle rotation
- Program package for machine pre-heating and media treatment
- Complete demineralising unit
- Automatic chemicals dosing
- Draining pump
- Collecting tray in accordance with Cl. 19 German Water Management Act (WHG) including oil level sensor
- Charging trolley
- Manual roller conveyor
- Automatic transfer system
- Modem for remote maintenance of the control system
- User-friendly MAFAC MAVIATIC plus touch panel, 12 inch, with graphic process visualisation

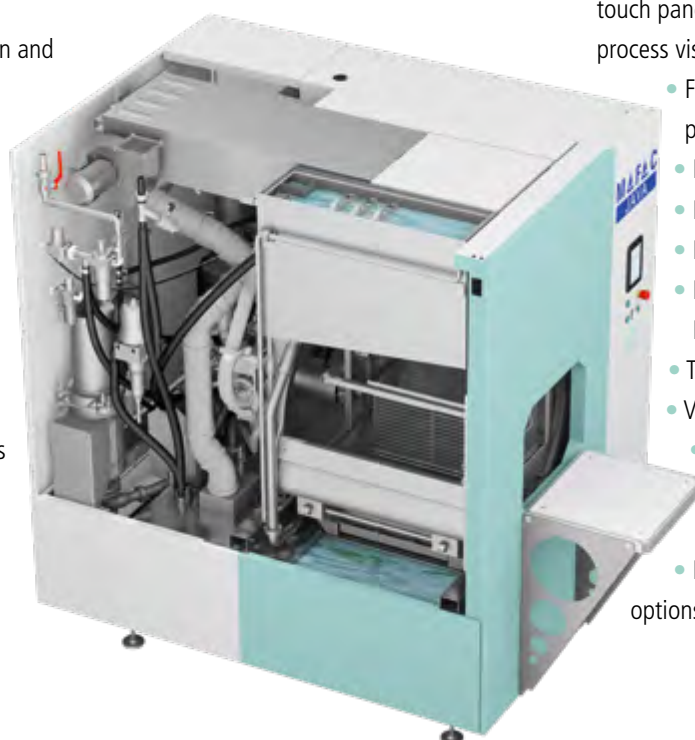

- Frequency-controlled pump pressure
- Reinforced pump systems
- Rinse water treatment module
- Fresh water rinsing system
- Heat exchange module MAFAC HEAT.X
- Targeted cleaning and drying
- Vector kinematics
 - Vacuum Activated Purification (VAP)
 - Customised colours
- Larger versions and further options on request

Dimensions:

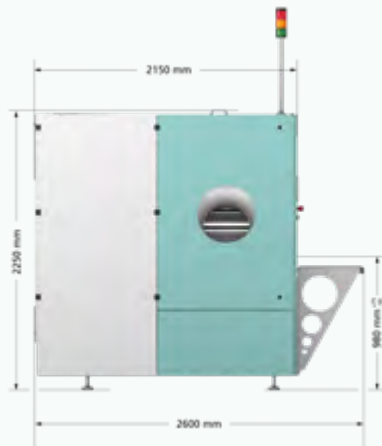

Height with option
"vacuum drying": 2750 mm

FOR MORE INFORMATION:

https://www.mafac.de/go/JAVA_EN

https://www.mafac.de/go/JAVA_mov

https://www.mafac.de/go/Hecker_EN

https://www.mafac.de/go/Isabelle_EN

https://www.mafac.de/go/Auto_EN

https://www.mafac.de/go/Eckerle_EN

Spraying pressure pump, standard version			Return filtration		Main stream ultra-fine filtration		
Flow volume	Pressure	Output	Fineness	Surface area	Fineness	Surface area	
Cleaning process holding tank 1:							
360 l/min	3,5 bar	4,0 kW	150 µm	0,56 m²	100 µm	1 x 0,48 m²	
Rinsing process holding tank 2:							
260 l/min	1,8 bar	2,2 kW	150 µm	0,28 m²	50 µm	1 x 0,24 m²	
Holding tanks:			Content	Heating time	Temperature	Heating Capacity	
1-bath version	Holding tank 1, cleaning (including oil separator):		830 litres	approx. 2,0 h	max. 75°C	30 kW	
	Holding tank 2, rinsing:		290 litres	approx. 1,5 h	max. 75°C	15 kW	
2-baths version		Holding tank 1, cleaning (including oil separator):		540 litres	approx. 2,5 h	max. 75°C	15 kW
		Holding tank 2, rinsing:		290 litres	approx. 1,5 h	max. 75°C	15 kW
Connections:			Electronics: 400 V, 3 Ph, 50 Hz				
			Compressed air : Rp ¾ inch, 5 – 8 bar				
			Fresh water: Rp ¾ inch, 0,5 – 10 bar				
			Waste water: Rp 1½ inch				
			Exhaust air: 113 x 105 mm				
Exhaust extraction/condensation:			Mean volumetric flow rate: 450 m³/h				
Ultrasonic cleaning unit:			Frequency: 25 kHz, Output: 1 x 1,500 W				
			Frequency: 25 kHz, Output: 1 x 2,000 W				
			Frequency: 40 kHz, Output: 1 x 1,000 W				
Drying systems:			Impulse blowing system: 3 – 6 bar, < 45°C				
			Hot air blowing system: 0,22 bar, max. 90°C, volume flow: 180 m³/h				
			Combined impulse/hot blowing system				
			Vacuum drying system: < 10 mbar, volume flow: 300 m³/h				
Weights:			Batch: max. 100 kg, optionally max. 250 kg				
			Basic machine without medium: 1300 kg				
			Basic machine with medium: 2130 kg				
Machine colour:			Light grey, RAL 7035				
			Light green, RAL 6027				
Technical details for further features and options are available on request.							

MAFAC PALMA

Spray and flood cleaning perfectly combined



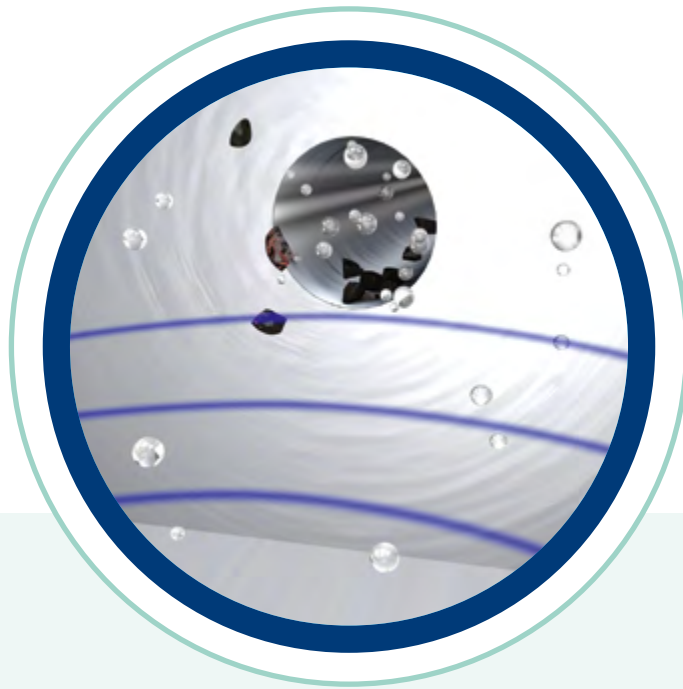

alignment with customer-specific requirements. If needed, the MAFAC PALMA can be equipped with a third holding tank to integrate an additional wet process.

**Energy-efficient:
Rotating hot air drying system**

Based on the patented basketspray frame rotation, MAFAC has developed a special hot air flow drying system. It is especially designed for high-quality full body drying of parts with complex shapes, in particular for parts with recessed areas, e.g. narrow bevels and undercuts. As a result, process times are reduced while efficiency is increased significantly due to the enhanced drying performance.

The MAFAC PALMA offers ideal features for process-safe cleaning of sensitive parts with complex shapes. During the wet phase, spray and flood cleaning can be individually combined to achieve optimal cleaning

results. A special quick-flood system allows for full flooding of the cleaning chamber within only 30 seconds.

**Optional:
Ultrasonic unit for ultrafine cleaning**

For applications with very high demands on cleanliness, e.g. in the watch-making industry, in medical technology and precision engineering, the system can be equipped with an optional ultrasonic unit. The exact fine adjustment of the performance design of the ultrasonic processes ensures a perfect



MAFAC PALMA

Standard features and options

Standard features:

- Patented rotating, multi-sided spray system with counter-rotating basket receptacle system. A special nozzle arrangement ensures reliable cleaning results
- Front loading with vertical sliding door and loading table
- Spray cleaning, flood cleaning and rinsing in one machine
- Large holding tanks with cascaded design for a long useful bath life
- Standard Euro baskets can be used (600L X 400B 288H mm)
- Removable basket filter for collecting coarse dirt particles in the return flow from the cleaning/rinsing process
- Separate bath heating system with digital temperature control and limitation
- Steam extraction with condensation and mist separator
- Powerful coalescing oil separator with maximum monitoring of the oil collection tank
- Automatic medium level control
- Thermal insulation of the holding tank
- Water contact components made of stainless steel / plastic
- Easy-to-use MAFAC MAVIATIC plus touch panel
- Floodable cleaning chamber

Options:

- Rotating hot air impulse blowing system
- Combined rotating hot air impulse blowing and hot air drying system
- Vacuum drying
- Additional spray process with holding tank 3
- Ultrasonic cleaning system incl. parabolic reflector for optimum efficiency of the ultrasonic waves
- Window in the cleaning chamber allows observation of the cleaning process
- Working tank adaptation to 660L x 480W x 338H mm
- Mechanical main stream ultrafine filtration with filter bags or filter candles

- Speed control for basket rotation including rocking motion
- Speed control of nozzle rotation
- Program package for machine pre-heating and media treatment
- Complete demineralising unit
- Automatic chemicals dosing
- Draining pump
- Collecting tray in accordance with Cl. 19 German Water Management Act (WHG) including oil level sensor
- Charging trolley
- Manual roller conveyor
- Automatic transfer system
- Modem for remote maintenance of the control system
- User-friendly MAFAC MAVIATIC plus touch panel, 12 inch, with graphic process visualisation

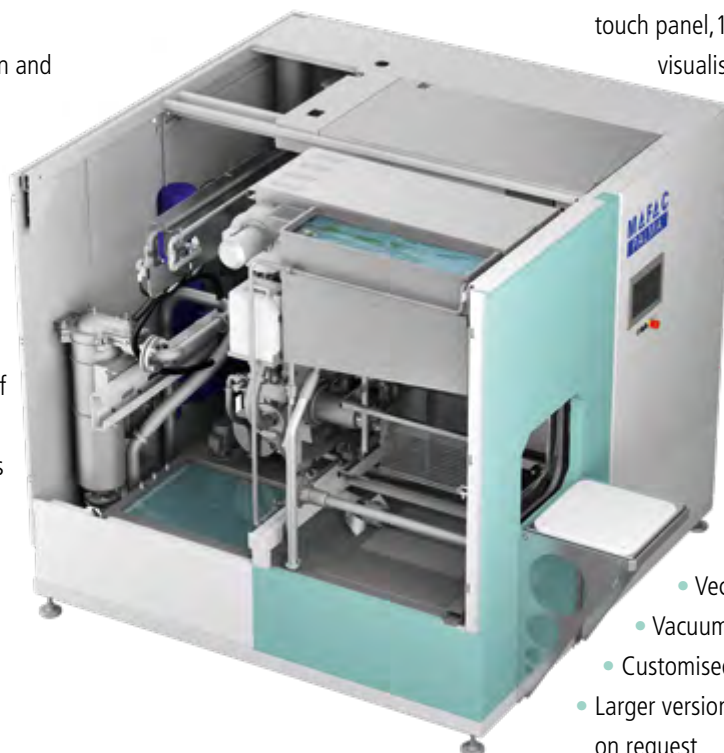

- Frequency-controlled pump pressure
- Reinforced pump systems
- Rinse water treatment module
- Fresh water rinsing system
- Heat exchange module MAFAC HEAT.X
- Targeted cleaning and drying
- Vector kinematics
- Vacuum Activated Purification (VAP)
- Customised colours
- Larger versions and further options on request

Dimensions:

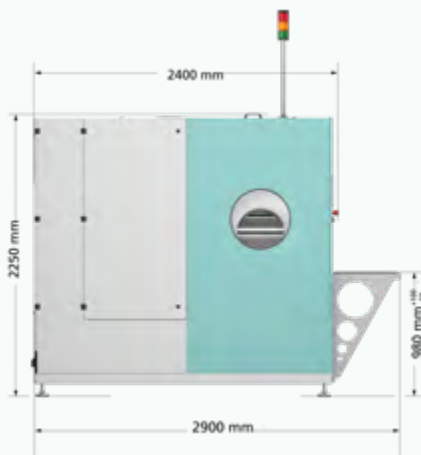

Height with option
"vacuum drying": 2750 mm

FOR MORE INFORMATION:

https://www.mafac.de/go/PALMA_EN

https://www.mafac.de/go/Trumpf_EN

https://www.mafac.de/go/Alpla_EN

https://www.mafac.de/go/Dick_EN

https://www.mafac.de/go/PALMA_anim_EN

https://www.mafac.de/go/MB_EN

Spraying pressure pump, standard version			Return filtration		Main stream ultra-fine filtration	
Flow volume	Pressure	Output	Fineness	Surface area	Fineness	Surface area
Cleaning process holding tank 1:						
360 l/min	3,5 bar	4,0 kW	150 µm	0,56 m ²	100 µm	1 x 0,48 m ²
Rinsing process holding tank 2:						
360 l/min	3,5 bar	4,0 kW	150 µm	0,56 m ²	50 µm	1 x 0,48 m ²
Optional final rinsing process holding tank 3:						
250 l/min	2,5 bar	2,2 kW			25 µm	1 x 0,24 m ²
Holding tanks:			Content	Heating time	Temperature	Heating Capacity
2-baths version	Holding tank 1, cleaning (including oil separator):		735 litres	approx. 3,0 h	max. 75°C	15 kW
	Holding tank 2, rinsing:		590 litres	approx. 2,5 h	max. 75°C	15 kW
3-baths version (optional)	Holding tank 3, final rinsing:		500 litres	approx. 3,0 h	max. 75°C	10 kW
Connections:			Electronics: 400 V, 3 Ph, 50 Hz			
			Compressed air : Rp ¾ inch, 5 – 8 bar			
			Fresh water: Rp ¾ inch, 0,5 – 10 bar			
			Waste water: Rp 1½ inch			
			Exhaust air: 113 x 105 mm			
Exhaust extraction/condensation:			Mean volumetric flow rate: 450 m ³ /h			
Ultrasonic cleaning unit:			Frequency: 25 kHz, Output: 2 x 1,500 W			
			Frequency: 25 kHz, Output: 2 x 2,000 W			
			Frequency: 40 kHz, Output: 2 x 1,000 W			
Drying systems:			Impulse blowing system: 3 – 6 bar, < 45°C			
			Hot air blowing system: 0,24 bar, max. 90°C, volume flow: 180 m ³ /h			
			Combined impulse/hot blowing system			
			Vacuum drying system: < 10 mbar, volume flow: 300 m ³ /h			
Weights:			Batch: max. 100 kg, optionally max. 250 kg			
			Basic machine without medium: 2100 kg			
			Basic machine with medium: 3425 kg			
Machine colour:			Light grey, RAL 7035			
			Light green, RAL 6027			
Technical details for further features and options are available on request.						

MAFAC PALMA XL

Cleanliness in size XL





Efficient cleaning of large parts and batches

For workpieces with large dimensions or large-scale batches, MAFAC PALMA XL provides high flexibility and excellent cleaning performance. It includes all advantages of the MAFAC PALMA basic model, like individually combined spray and flood cleaning. Double or triple-bath technology meeting strict requirements on cleanliness is available for the large model of the machine, achieving efficient cleaning.

Optional: Ultrasound and vacuum drying

For the treatment of sensitive parts with complex shapes, the MAFAC PALMA XL is

optionally available with an ultrasonic unit and a vacuum drying system. Both processes are optimally adapted to the customer-specific requirements, facilitating an optimised cleaning and effective drying process.

Flexibility and higher throughput

The MAFAC PALMA XL allows batch and component sizes of 800L x 600W x 400H mm, with a weight of 250 kg. The dimensions of the basket receptacle system were selected so that standardised containers can be combined with each other and a higher throughput can be achieved. Large components like crankcases, cylinder heads or hydraulic parts can be easily accommodated, as well as large-scale batches.

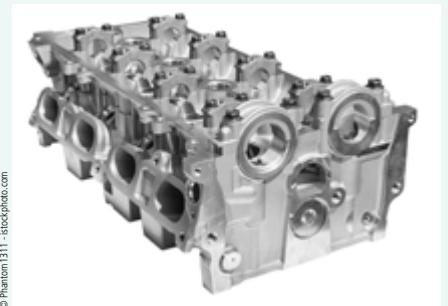

© Phantom1311 - iStockphoto.com

With a transfer system or a manual roller conveyor selected to suit the higher basket weight, the machine can be easily loaded from the front despite the large dimensions of the items to be cleaned.



© susanah_perchang - iStockphoto.com

MAFAC PALMA XL

Standard features and options

Standard features:

- Patented rotating, multi-sided spray system with counter-rotating basket receptacle system. A special nozzle arrangement ensures reliable cleaning results
- Front loading with vertical sliding door and loading table
- Spray cleaning, flood cleaning and rinsing in one machine
- Large holding tanks with cascaded design for a long useful bath life
- Standard Euro baskets can be used (800L X 600B 400H mm)
- Removable basket filter for collecting coarse dirt particles in the return flow from the cleaning/rinsing process
- Separate bath heating system with digital temperature control and limitation
- Steam extraction with condensation and mist separator
- Powerful coalescing oil separator with maximum monitoring of the oil collection tank
- Automatic medium level control
- Thermal insulation of the holding tank
- Water contact components made of stainless steel / plastic
- Easy-to-use MAFAC MAVIATIC plus touch panel
- Floodable cleaning chamber

Options:

- Rotating hot air impulse blowing system
- Combined rotating hot air impulse blowing and hot air drying system
- Vacuum drying
- Additional spray process with holding tank 3
- Ultrasonic cleaning system incl. parabolic reflector for optimum efficiency of the ultrasonic waves
- Window in the cleaning chamber allows observation of the cleaning process
- Mechanical main stream ultrafine filtration with filter bags or filter candles
- Speed control for basket rotation including rocking motion
- Speed control of nozzle rotation

- Program package for machine pre-heating and media treatment
- Complete demineralising unit
- Automatic chemicals dosing
- Draining pump
- Collecting tray in accordance with Cl. 19 German Water Management Act (WHG) including oil level sensor
- Charging trolley
- Manual roller conveyor
- Automatic transfer system
- Modem for remote maintenance of the control system
- User-friendly MAFAC MAVIATIC plus touch panel, 12 inch, with graphic process visualisation
- Frequency-controlled pump pressure
- Reinforced pump systems
- Rinse water treatment module
 - Fresh water rinsing system
 - Heat exchange module MAFAC HEAT.X
 - Customised colours
 - Further options on request

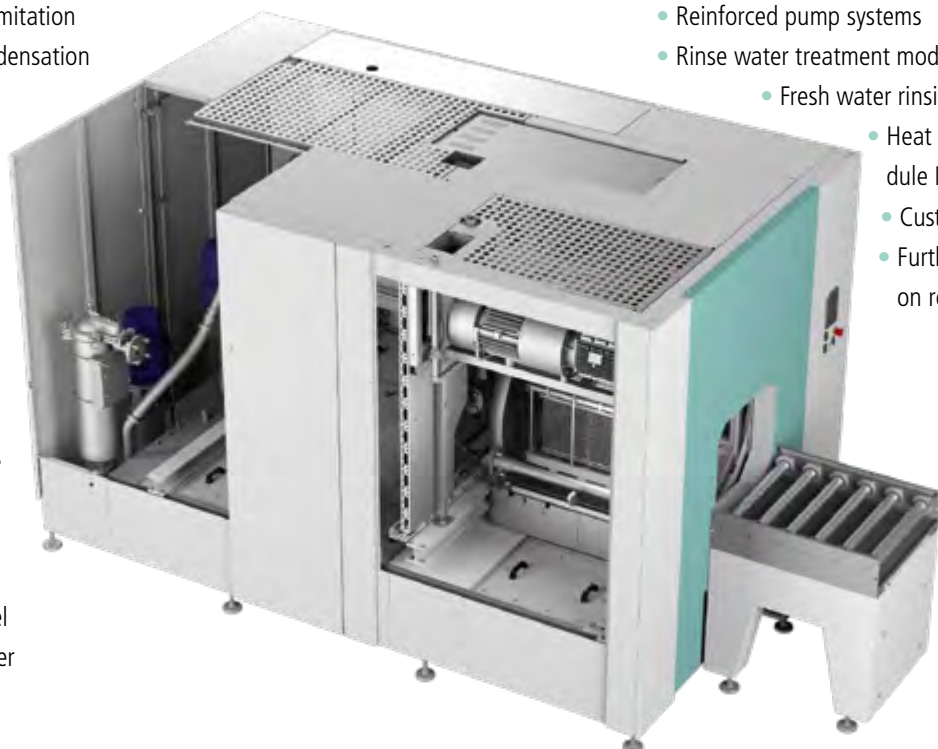

Dimensions:

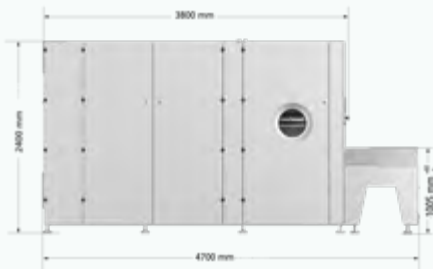

Spraying pressure pump, standard version			Return filtration		Main stream ultra-fine filtration	
Flow volume	Pressure	Output	Fineness	Surface area	Fineness	Surface area
Cleaning process holding tank 1:						
360 l/min	6,5 bar	7,5 kW	150 µm	0,56 m ²	100 µm	1 x 0,48 m ²
Rinsing process holding tank 2:						
350 l/min	5,5 bar	5,5 kW	150 µm	0,56 m ²	50 µm	1 x 0,48 m ²
Optional final rinsing process holding tank 3:						
350 l/min	5,5 bar	5,5 kW			25 µm	1 x 0,48 m ²
Holding tanks:			Content	Heating time	Temperature	Heating Capacity
2-baths version	Holding tank 1, cleaning (including oil separator):		1.150 litres	approx. 2,0 h	max. 75°C	30 kW
	Holding tank 2, rinsing:		1.050 litres	approx. 2,0 h	max. 75°C	30 kW
3-baths version (optional)	Holding tank 3, final rinsing:		620 litres	approx. 2,5 h	max. 75°C	20 kW
Connections:			Electronics: 5x 400 V, 50 Hz			
			Compressed air : Rp ¾ inch, 5 – 8 bar			
			Fresh water: Rp ¾ inch, 0,5 – 10 bar			
			Waste water: Rp 1½ inch			
			Exhaust air: 113 x 105 mm			
Exhaust extraction/condensation:			Mean volumetric flow rate: 600 m ³ /h			
Ultrasonic cleaning unit:			Frequency: 25 kHz, Output: 2 x 2,000 W			
			Frequency: 25 kHz, Output: 4 x 2,000 W			
			Frequency: 40 kHz, Output: 2 x 1,000 W			
			Frequency: 40 kHz, Output: 4 x 1,000 W			
Drying systems:			Impulse blowing system: 3 – 6 bar, < 45°C			
			Hot air blowing system: 0,3 bar, max. 90°C, volume flow: 140 m ³ /h			
			Combined impulse/hot blowing system			
			Vacuum drying system: < 10 mbar, volume flow: 300 m ³ /h			
Weights:			Batch: max. 250 kg, optionally max. 500 kg			
			Basic machine without medium: ca. 3000 kg			
			Basic machine with medium: ca. 5200 kg			
Machine colour:			Light grey, RAL 7035			
			Light green, RAL 6027			
Technical details for further features and options are available on request.						

MAFAC MALTA

Particle-free degreasing





Particle-free degreasing

When searching for a suitable cleaning process and agent, the old rule “dissolving like with like” is still a good guideline. Water-based technologies are used for inorganic contaminations such as emulsions, salts and polishing pastes. The removal of particulate residues such as chips, burrs and abrasion is also considered a job for aqueous parts cleaning. Organic film contaminants such as oils and fats, on the other hand, are largely treated with hydrocarbon and CHC-based systems. However, especially

when parts have to be degreased, there are applications for which the increasingly precise processes of aqueous cleaning are ideally suited.

MAFAC has developed a new generation of machines for aqueous cleaning of precision components in response to the increasing demands of the downsizing trend in the industry. With its new kinematic process technology, this machine is designed for efficient, premium-quality cleaning of small components. A compact machine that can be

configured individually for customer needs provides this new method as a standard.



© marvini - stockphoto.com



© bueffli - stockphoto.com



MAFAC MALTA

Standard features and options

Standard features:

- Patented rotating, 6-sided spray system with counter-rotating basket receptacle system. A special nozzle arrangement ensures reliable cleaning results
- Front loading with horizontal sliding door and loading table
- Spray cleaning, flood cleaning and rinsing in one machine
- Large holding tanks with cascaded design for a long useful bath life
- Standard Euro baskets can be used (471L X 321B 200H mm)
- Removable basket filter for collecting coarse dirt particles in the return flow from the cleaning/rinsing process
- Separate bath heating system with digital temperature control and limitation
- Steam extraction with condensation and mist separator
- Powerful coalescing oil separator with maximum monitoring of the oil collection tank
- Automatic medium level control
- Thermal insulation of the holding tank
- Water contact components made of stainless steel / plastic
- Intuitive MAFAC MAVIATIC touch panel
- Floodable cleaning chamber
- Window in the front of the machine allows observation of the cleaning process
- Optimised design of the electropolished treatment chamber to minimise media carry-over

Options:

- Rotating hot air impulse blowing system
- Combined rotating hot air impulse blowing and hot air drying system
- Vacuum drying
- Additional spray process with holding tank 3
- Rotatable and positionable ultrasonic cleaning system
- Mechanical main stream ultrafine filtration with filter bags or filter candles
- Speed control for basket rotation including rocking motion
- Speed control of nozzle rotation
- Program package for machine pre-heating and media treatment
- Complete demineralising unit
- Automatic chemicals dosing
- Draining pump
- Collecting tray in accordance with Cl. 19 German Water Management Act (WHG) including oil level sensor
- Charging trolley
- Manual roller conveyor
- Automatic transfer system
- Modem for remote maintenance of the control system
- User-friendly MAFAC MAVIATIC plus touch panel, 12 inch, with graphic process visualisation
- Service black box
- Frequency-controlled pump pressure
- Reinforced pump systems
- Rinse water treatment module
- Fresh water rinsing system
- Heat exchange module MAFAC HEAT.X
- Customised colours
- Further options on request



Dimensions:

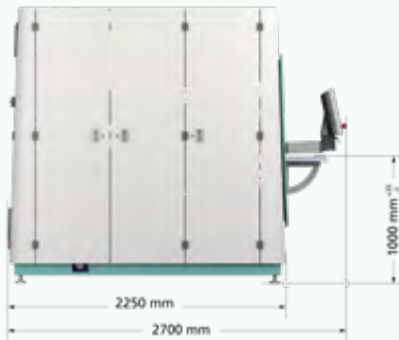
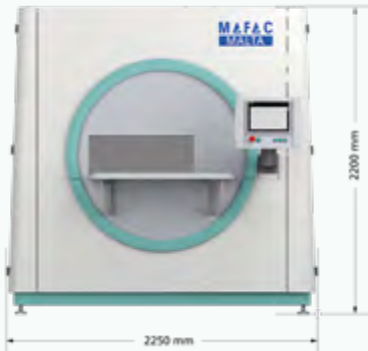

Depth with option
"Holding tank 3": 2850 resp. 3300 mm

FOR MORE INFORMATION:

https://www.mafac.de/go/MALTA_EN

https://www.mafac.de/Ultra_EN

Spraying pressure pump, standard version			Return filtration		Main stream ultra-fine filtration	
Flow volume	Pressure	Output	Fineness	Surface area	Fineness	Surface area
Cleaning process holding tank 1:					Flowline filter housing	
180 l/min	2,5 bar	2,2 kW	150 µm	0,45 m ²	25 µm	0,24 m ²
Rinsing process holding tank 2:					Flowline filter housing	
180 l/min	2,5 bar	2,2 kW	150 µm	0,45 m ²	25 µm	0,24 m ²
Optional final rinsing process holding tank 3:					Flowline filter housing	
180 l/min	2,5 bar	2,2 kW	–	–	25 µm	0,24 m ²

Holding tanks:		Content	Heating time	Temperature	Heating Capacity
2-baths version	Holding tank 1, cleaning (including oil separator):	approx. 410 litres	approx. 2,5 h	max. 75°C	10 kW
	Holding tank 2, rinsing:	approx. 355 litres	approx. 2,5 h	max. 75°C	10 kW
3-baths version (optional)	Holding tank 3, final rinsing:	approx. 355 litres	approx. 2,5 h	max. 75°C	10 kW

Connections:
Electronics: 400 V, 3 Ph, 50 Hz
Compressed air : Rp ¾ inch, 5 – 8 bar
Fresh water: Rp ¾ inch, 0,5 – 10 bar
Waste water: Rp 1½ inch
Exhaust air: DN 110 mm

Exhaust extraction/condensation:
Mean volumetric flow rate: 450 m ³ /h

Ultrasonic cleaning unit:
Frequency: 25 kHz, Output: 2 x 800 W

Drying systems:
Impulse blowing system: 3 – 6 bar, < 45°C
Hot air blowing system: 130 m ³ /h, 0,3 bar, max. 90°C
Combined hot air/impulse blowing system possible
Vacuum drying system: < 10 mbar, volume flow: 300 m ³ /h

Weights:
Batch: 75 kg
Machine without medium: ca. 2200 kg
Machine with medium: ca. 3300 kg

Machine colour:
Grauweiß, RAL 9002
Light green, RAL 6027

Technical details for further features and options are available on request.

MAFAC CONTINUO

to speed up your processes





The automatic transfer system MAFAC CONTINUO is made up of modules that can be integrated into the production environment in a flexible manner. At the same time, it is optimally tuned to the MAFAC cleaning machines and enables operation with up to five goods baskets or workpiece carriers in the loading and unloading area. MAFAC CONTINUO operates according to a flexible waiting queue principle and provides for reliable, unmanned transporting, buffering and separation of workpiece carriers with material to be cleaned. Thanks to these features, it can be used across all sectors of industry and is particularly suited for areas with a high volume of parts. This gives you a compact solution for optimum use of the parts washer. In addition, the manpower requirements are reduced. At the same time, the principle "All from one source" contributes essentially to an even more customer-friendly service.

Basic configuration for a safe operation

In its standard configuration, the MAFAC CONTINUO unites all the important functions required for a smooth and space-saving transfer of dirty components into the MAFAC cleaning machine and of baskets with cleaned parts into the removal station. It is possible to transport baskets or work piece carriers of varying dimensions with a batch weight of up to 100 kg. A partial enclosure in the loading and unloading area is integrated in the standard configuration and provides safety.

Special options for individual requirements

The MAFAC CONTINUO can be expanded in modular fashion as needed. Beyond that, the load carrying capacity of the transfer system can be increased to up to 250 kg per buffer station. The mobile transport cart MAFAC MOBILLO is available for loading the

MAFAC CONTINUO. An indexing station that is available as an option additionally allows for automatic robot loading.

OVERVIEW OF OPTIONS:

- Separation behind the loading station, so that baskets can be loaded on the transfer system
- Separation before the unloading station so that further baskets/workpiece carriers are held back on the buffer station
- Short enclosure only above the loading station for completely accessible buffer section
- Guide rollers under the frame for easy movement, e.g., for service work
- Mounted frames to extend the buffer stations, also possible asymmetrically, always with drip tray for loading side, without drip tray for unloading side
- Increase of load carrying capacity to 250 kg
- Loading with MAFAC MOBILLO
- Drip tray at the unloading side
- Chaotic programme selection
- Control panel on external pedestal
- Extension to robot operation
- Reversing operation of baskets and workpiece carriers

FOR MORE INFORMATION:

https://www.mafac.de/go/CONTINUO_anim

MAFAC system solutions

Systems for fully automated parts cleaning

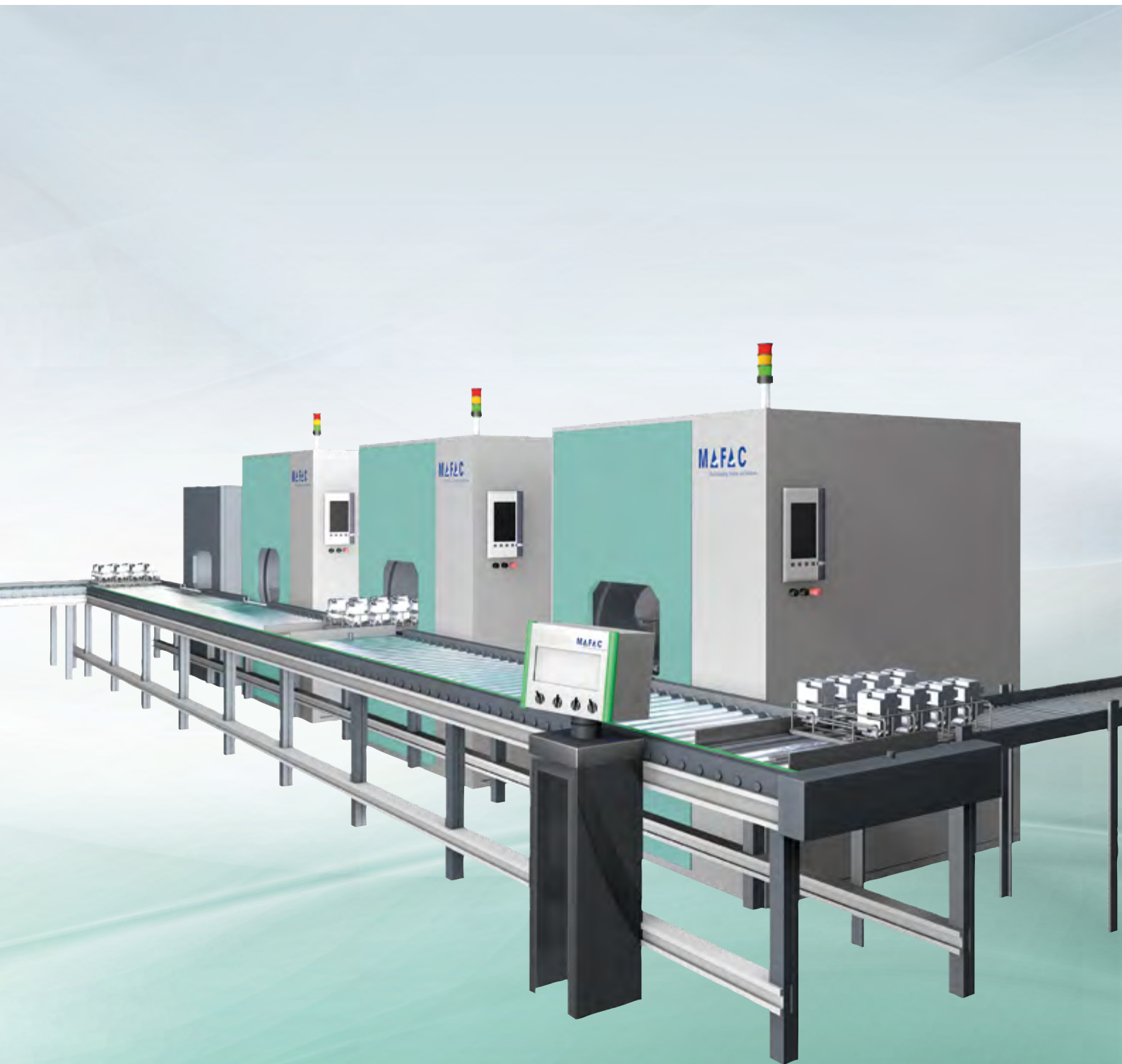



Are you interested in integrated system solutions for fully automated parts cleaning? MAFAC is your expert partner in this range, too. Our experienced project team can develop custom-made process solutions according to your specific requirements.

Multi-stage cleaning processes for maximum efficiency

Based on our tried and tested MAFAC parts cleaning systems, we develop sophisticated automated solutions - all from a single source and adaptable across a wide range of machines. The linking of several individual machines to form a comprehensive system concept is the basis for multi-stage cleaning processes with maximum efficiency. Intelligent system configuration ensures a sustainable reduction of cycle times.

High repeatability due to perfect functional interaction

Our patented machine and process technology is enhanced by high-quality peripheral devices. Based on a clever combination of logistics and transfer systems we ensure safe processes and thus high repeatability of the cleaning results.



FOR MORE INFORMATION:

<https://www.mafac.de/go/Automation>

Energy-efficient cleanliness

Optimised process solutions





Saving costs with optimised process solutions

Environmental protection and saving of energy are key topics in industry. It is not just essential to protect precious resources and lower CO₂ emissions, but also to reduce operating and manufacturing costs for the benefit of competitiveness. To enable our customers to sustainably reduce their energy

consumption in industrial parts cleaning, we have for years been committed to the research and development of technical alternatives for the benefit of resource-saving component cleaning, for instance through our involvement with the ETA Research Factory at the Technical University of Darmstadt. Our portfolio now includes a number of effective technology modules

which can achieve significant energy savings and a reduction of CO₂ emissions.

FOR MORE INFORMATION:

<https://www.mafac.de/go/Efficiency>

https://www.mafac.de/go/Efficiency_EN

Model calculation

Savings in energy costs

The following example demonstrates the relevant savings potential: Comparison with a MAFAC JAVA with electric heating and without rotation and full heat insulation, running in 3shift operation with 6 batches per hour, a process time of 555 sec. validated for one- to three-shift operation, a cleaning temperature of 75°C and loaded with steel parts with a total weight incl. basket of 70 kg, with the process steps spray cleaning, spray flooding, spray rinsing, impulse blowing, and hot blowing.

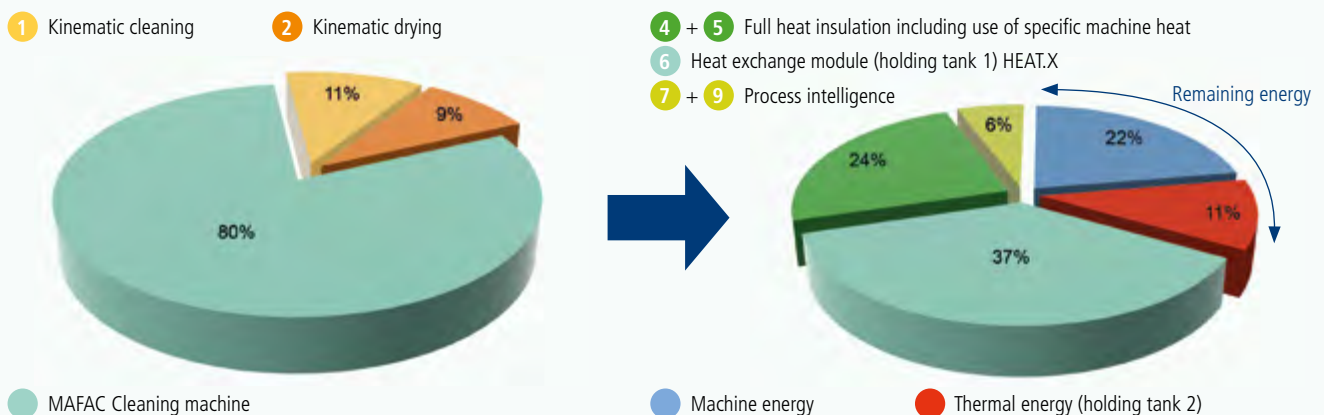

Saving energy

Technology modules to protect resources

1

Kinematic cleaning and drying

Compared to stationary nozzle systems, the patented MAFAC process of co or counter-rotation of basket and nozzle system offers significant potential for saving energy and time. In terms of the process-specific energy requirements of the machine, up to 30% of the energy can be saved in the cleaning process and as much as up to 42% in the drying process. These values were determined by internal comparison tests with MAFAC machines with standardised parts in a standardised process. All standard versions of the MAFAC cleaning machines are equipped with the rotational cleaning feature, while rotational drying is available as an option.

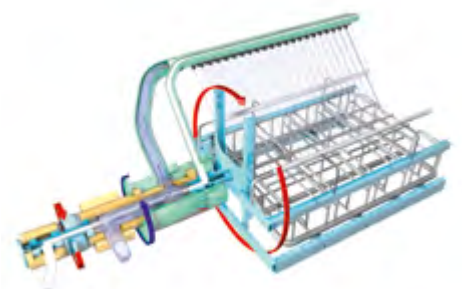

2



3

Targeted global and partial cleaning and drying

When cleaning parts with complex geometries, it is often the case that valuable resources and much time are invested with the result that the easy-to-access parts are "overcleaned" before the hidden interior contours are cleaned according to requirements. To address this problem, MAFAC developed a new process for partial targeted cleaning, rinsing and drying. When combined with the rotating basket and nozzle system, it offers the user additional potential for saving time and energy. The process requires a workpiece positioning system individually adjusted to the customer's needs. Currently, it can be used with the MAFAC JAVA and MAFAC PALMA.

<https://www.mafac.de/go/targeted>

4

Full heat insulation

The insulation of the entire machine including doors, units, flow ducts and holding tanks reduces the machine's thermal energy requirement by 29%. This was shown in the ETA Factory via comparing a standardised process run without parts load in a fully insulated and a non-insulated MAFAC JAVA. Additionally, insulation reduces the heat emission by 30%, resulting in lower costs for air conditioning on the shop floor. Furthermore, the Aweighted sound pressure level is reduced by 9%. Both factors significantly improve the working conditions on site. Full heat insulation is available as an option.

<https://www.mafac.de/go/Insulation>



5

Internal use of the specific heat of the machine for pre-warming the drying air

The full heat insulation of a machine yields additional energy savings of 2.5 to 4% (in relation to the total energy requirement) by recuperating the specific heat of the machine for prewarming the air used in hot air flow drying. These savings are included in the calculation in item 3.



6

Using the existing external heat for heating the holding tanks

For heating the holding tanks, alternative sources such as the hot water from the heat treatment, combined heat and power generation, and regenerative water heating applications (solar heat) can be used. They can be integrated by means of the heat exchanger module MAFAC HEAT.X. Thus, using existing heat can reduce the energy consumption for heating bath 1 (which as a rule consumes more than 90% of the total thermal energy required) by more than 90% and also lower the respective CO₂ emissions. The heat exchanger module is also easy to retrofit in existing machines.

https://www.mafac.de/go/HEATX_EN

7

Sensory process intelligence

Intelligent hardware and software solutions can stabilise peak loads and avoid the simultaneous operation of processes. This can save approx. 1% of the total energy consumption.

8

Internal recuperation of exhaust heat for fresh water pre-warming via bionic dehumidification

Bionic dehumidification is a current development project of MAFAC's. It not only lowers the energy consumption for fresh water pre-warming but also reduces heat emission by up to 90% and aerosol emission by up to 80%, which benefits the working conditions on site and the environment. Employee health is furthermore significantly improved by the removal of particulate and film contamination in the exhaust air and the elimination of odours.

9

Training and process optimisation

Well-trained employees who regularly service the machines and check the processes also help to successfully save resources. If requirements change or after many years of operation, a process optimisation by MAFAC is recommended. In many cases, savings potentials of up to 5% of the total energy consumption can be identified, followed by the corresponding process optimisation.

https://www.mafac.de/go/Opti_EN



Further accessories

Optimised cleanliness

Workpiece holders



Euro standard basket

- to hold workpieces
- with lid with adjustable height
- various mesh sizes
- pickled and electropolished stainless steel

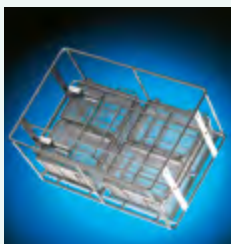

Multiple basket frame

- to accept a number of smaller sized baskets for bulk materials
- flexible solution: several baskets with different dimensions and mesh sizes can be used
- incl. clamping cover to hold the baskets in place

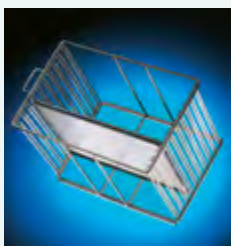

Customised workpiece holders

- to hold sensitive components
- suitable for single workpieces as well as batches

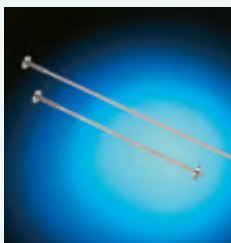

Compartment rods

- for quick and easy fixing of components inside the basket

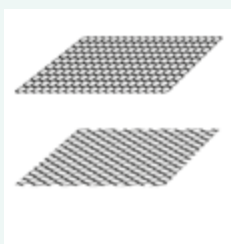

Shelving and plastic inserts

- to separate parts and as an interlayer for improved parts protection

Process optimisation



Stationary rinse cycle (with additional tank) for fresh water rinsing

- benefits: no carry-over, perfectly clean surfaces



Complete demineralising unit

- to improve water quality and the related rinsing results
- reduces staining

Maintenance of wash tanks



Filter cartridges and bags for our standard filter housings

- available in various filter grades and diverse filter materials

Detergent concentration test kit

- for improved process reliability



Safety and cleanliness

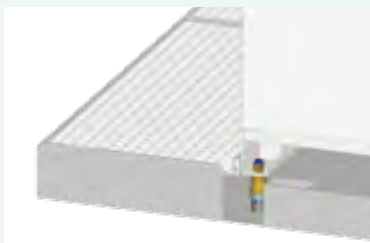

Collecting pan with levelling elements

- for more safety in accordance with Cl. 19 German Water Management Act (WHG)



Drip tray

- protects floors against dripping liquids

Handling

MOBILO charging trolley

- for loading MAFAC cleaning systems and for in-house transport of baskets/workpiece holders
- adjustable height
- with drip tray



Draining pump for waste water/sludge

- user-friendly device to drain the holding tank



Service plus

We get moving for you





The MAFAC service portfolio is based on three strong pillars:

**Application engineering -
Parts cleaning with know-how**

We keep a strong focus not only on the impeccable quality of our products but also on tailored customer advice. Experienced application engineers help you to optimise your cleaning processes in terms of economic and energy efficiency. Our own technical centre is the perfect environment for trial cleaning runs to find the process-safe solution that meets your specific requirements.



**After-Sales-Service –
Fast to respond and customised**

With our promise of quality we commit ourselves to a powerful service portfolio. Fast-responding and reliable, we ensure premium availability of your machine. Our planned and preventive maintenance, spare parts packages and retrofit kits are optimally tailored to your benefit. In this way, we continuously optimise the technology of our machines in line with your requirements, while always keeping an eye on the economic efficiency and requirements of tomorrow.

**Training –
Compact cleaning know-how**

With increasing demands in cleanliness, the aspects concerning aqueous parts cleaning are becoming increasingly complex. This is why our Cleaner College courses offer an extensive portfolio of training events for our customers, sales partners, and colleagues. Experienced trainers and experts provide sound theoretical and practical know-how on chemicals, cleaning technology, and machinery to small groups of students.

HIGHLIGHTS:

- Individual customer advice

- Trial cleaning runs at our technical centre

- Efficient production design

- Commissioning

- In-process training

- Conversions and retrofits

- Maintenance and repair

- Software updates

- 24/7 hotline

FOR MORE INFORMATION:

https://www.mafac.de/go/cc_EN



Parts Cleaning, Systems and Solutions.

MAFAC - E. Schwarz GmbH & Co. KG
Max-Eyth-Straße 2
D-72275 Alpirsbach
Phone + 49 (0) 74 44/95 09-0
Fax + 49 (0) 74 44/95 09-99
info@mafac.de
www.mafac.de

Ensuring cleanliness worldwide.

MAFAC technology worldwide

MAFAC has its roots in the Black Forest in Germany but can be found around the world. Our machines are used wherever high cleaning requirements, quality, process reliability and energy efficiency are of prime importance. Our global network of sales and service partners ensures reliable process setup, support and optimisation on site. You will find an overview of our field staff and sales partners on our website.

 **Sales Germany:** <https://www.mafac.de/go/Germany>

 **International sales:** <https://www.mafac.de/go/International>

 **Contact form:** <https://www.mafac.de/go/Contact>

Social media:

<https://www.mafac.de/go/xing>

<https://www.mafac.de/go/linkedin>

<https://www.mafac.de/go/facebook>

<https://www.mafac.de/go/youtube>