



Instruction manual

SK-L750 Series Dataloggers

No. 8800-00 Model SK-L751

(Temperature Measurement)

No. 8850-00 Model SK-L753

(Pt Sensor Temperature Measurement)

No. 8870-00 Model SK-L754

(Temperature/Humidity Measurement)

SATO KEIRYOKI MFG. CO., LTD.

Introduction

Thank you for purchasing the SK-L750 Series Dataloggers.

These products are designed to measure temperature and/or humidity. Do not use it for other purposes. Read this manual thoroughly before use, and keep it in a safe place for future reference.

WARNING

The SK-L750 Series Dataloggers are not explosion-proof. Never use it in an atmosphere containing flammable gases.



Beware of explosion!

Should you have any questions, please consult us or the retailer from which you have purchased.

SAFETY PRECAUTIONS

To use the Datalogger safely, follow the precautions below.

- Never disassemble or modify the unit. Doing so may cause a malfunction.
- The unit is precision devise. Never drop it or knock it over.
- Do not use the unit in a place exposed to direct sunlight or near a heat source. Doing so affects the measurement accuracy, and could result in a deformation or malfunction of the unit.
- Model SK-L754 Datalogger is not waterproof. Never let it get wet.
- Do not use the unit in a place subject to condensation, rain, drop of water, or vapor.
- Model SK-L751 and SK-L753 Dataloggers are waterproof. However, they become non-waterproof when AC adapter (for both) or sensor connector box (for SK-L753) is connected. Use batteries if they are placed near splashing water. For Model SK-L753, be sure not to wet the sensor connector box.
- If this unit is used in an environment where electrical noise is generated, the display may become unstable or the measurement error may increase.
- Never use the unit in an environment other than standard atmosphere.

- Measuring temperature or humidity out of the measurable range may result in malfunctions.
- When you use an AC adapter other than what we provide, be sure to use the one with the same rating and specifications as our adapter.
- If the unit is not used for a long period of time, remove the batteries. Otherwise, the batteries may leak resulting in malfunctions.
- Do not dispose of used batteries in a fire. For environmental conservation purposes, dispose of them in compliance with local rules and regulations.
- Keep the battery out of the reach of children. If the battery is swallowed accidentally, consult a doctor immediately.
- Do not wash or wipe this unit with alcohol, thinner, or other organic solvents. If the unit becomes dirty, wipe it with a tightly-wrung gauze or the like that has been dipped in warm water with neutral detergent.

For repair or calibration, contact us or the retailer from which you have purchased.

Disclaimer

We, Sato Keiryoki Mfg. Co., Ltd., check for general operation performance of the unit, however we do not guarantee for those under all possible situations. We do not take any responsibilities on any damages caused directly or indirectly by this unit.

The operation of our software has been checked by a combination of the Japanese edition OS and PCs sold in Japan. We shall not guarantee nor support the problems that occurred during the usage of OS or PCs of overseas models.

Remarks

Microsoft and Windows are trademarks of Microsoft Corporation.

All other company names, system names and products mentioned in this manual are their respective trademarks or registered trademarks.

Overview

The SK-L750 Series Dataloggers are the devices that log and store data of temperature and/or humidity. By using the dedicated software, you can monitor the environment and analysis the collected data on a computer.

Features

- **Storage of up to 16,000 data items**

Up to 16,000 data items can be logged, and the logged data can be copied to microSD card.

- **Retaining data**

The logged data can be retained even if batteries run out.

- **Waterproof structure**

Model SK-L751 and SK-L753 Dataloggers are dustproof and waterproof certified as IP65.

- **Four logging options**

Available for selection of the setting that best suits your needs

- **Interchangeability of probes**

The probes are interchangeably used with the main unit.

What's in the Package?

Check the content. If you find any item missing, please contact us or the retailer from which you have purchased.

<input type="checkbox"/> Datalogger	1x	<input type="checkbox"/> AA alkaline battery	2x
<input type="checkbox"/> Software CD-ROM	1x	<input type="checkbox"/> USB cable	1x
<input type="checkbox"/> Instruction manual	1x		
<input type="checkbox"/> Sensor cap (for SK-L751 and SK-L753)			1x
<input type="checkbox"/> Sensor connector box (for SK-L753 only)			1x

* **MicroSD card is not attached.**

* **Probes are sold separately.**

1. Names of Section

Front view

Model SK-L751

Model SK-L754

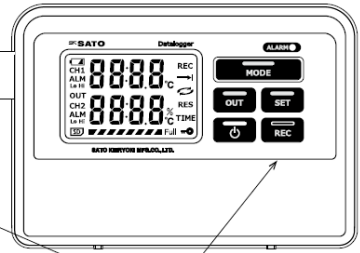
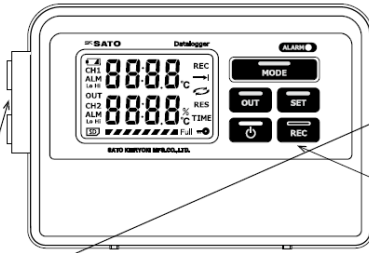

Model SK-L753

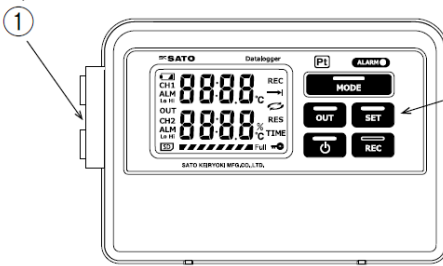

- ① Probe connector
- ② Operation keys
- ③ Port for AC adapter/USB cable
- ④ Battery cover
- ⑤ MicroSD card slot

Rear view

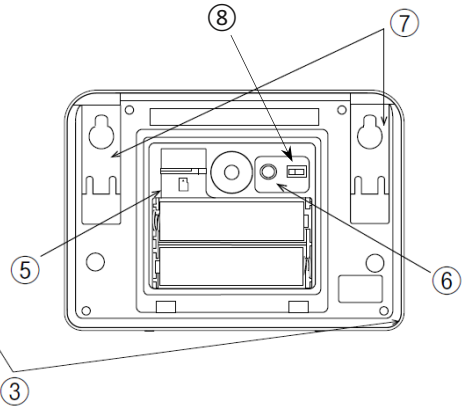
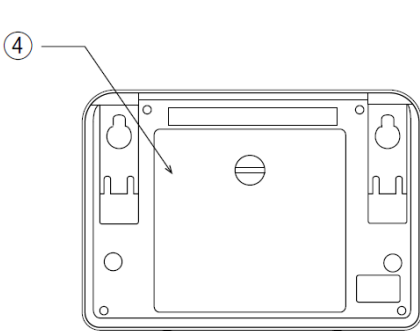

- ⑥ Reset switch: Press to reset when in malfunction.
- ⑦ Wall-mount hooks: Pull out to hang the unit on a wall.
- ⑧ °C/°F switch (only for SK-L751, SK-L754): "1" for °F, and "2" for °C. Switch it when the power is off and then the unit will change at the next startup.

LCD Display

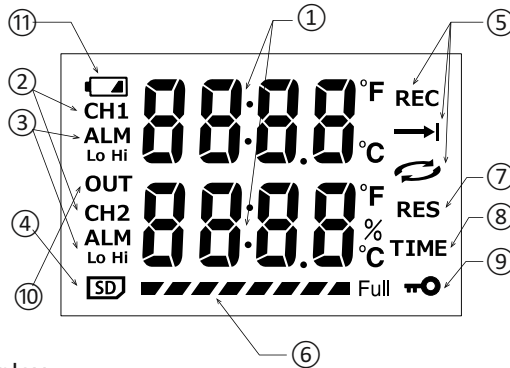

① Measurement display

Measured values and set values are indicated.

② CH1 CH2

Measurement channel is indicated.

③ ALM

Lights up while an alarm is set.



“ALM” flashes while the alarm is activated, and “Hi” or “Lo” flashes when the measured value exceeds or falls the alarm set value.



④

Lights up when a microSD card is inserted.

⑤ REC

Lights up during logging.

 lights up when the logging option is "Once".  lights up when the logging option is "Repeatedly".

 is displayed for “End at ...” and  is displayed for "By Pages" on the LCD.

⑥ Data memory bar graph

The number of lit segments increases as the number of logged data items increases. When the number reaches 16000, “Full” is lit.

⑦ RES

Flashes while in standby for preset start.

⑧ TIME

Lights up when the date and time is displayed.



Lights up when the key lock is operating.

⑩ **OUT**

Lights up when the unit is communicating with the PC.



Flashes if the battery level falls below the specified level.

Note: Logging continues after the flashing starts, but it automatically stops after a while.

Operation keys

① Power key

Long press for one second turns on or off the unit. When powered on, all indicators on the LCD are lit and measurement mode is activated.

② MODE key

Moves to setting mode or moves to the next setting item in setting mode.

③ SET key

Enables key lock during measurement mode or the like, or displays the readings in logging mode.

④ REC key

Starts or ends logging.

⑤ OUT key

Displays the measured value while in standby for preset start or copies the logged data to a microSD card.

⑥ ALARM light

Lights up if the measured value exceeds or falls from the alarm set value.

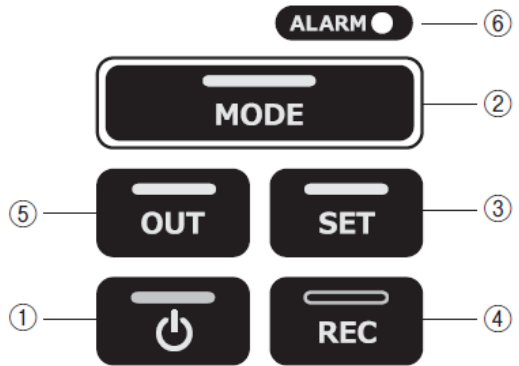

Standard probes

SK-L751-1 Plug-in Type Probe

SK-L754-1

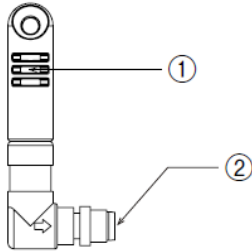

- ① Sensor section
- ② Connector to main unit
- ③ Sensor cord

SK-L751-2 With-sensor-cord Type Probe

SK-L754-2

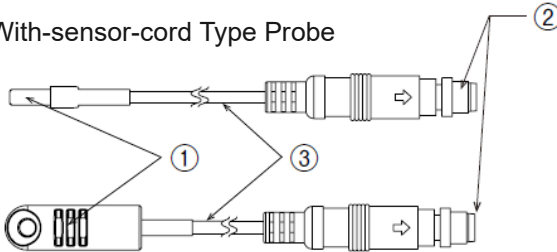

Pt sensor connector box for SK-L753

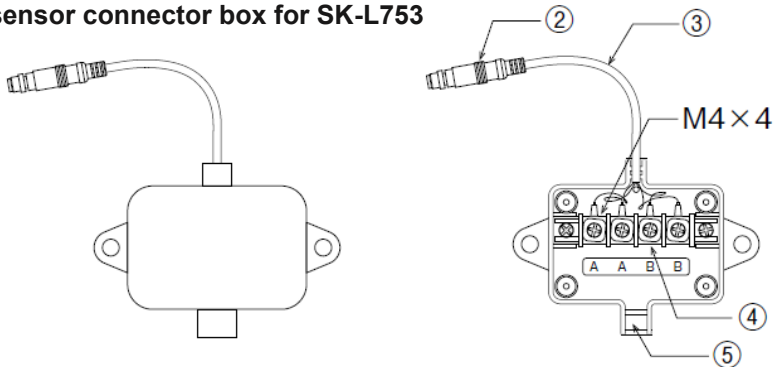

- ④ Terminal block
- ⑤ Sensor insertion point

Use this box to connect the main unit and a 4-wire sensor not made by us.
Choose appropriate sensor for your purpose.

2. Preparation

2.1 Installing batteries

When using the unit for the first time or when the low battery indicator is flashing, install batteries or replace the batteries with new ones as described below.

Also, an AC adapter can be connected to a USB port. When both the AC adapter and batteries are installed, the power is primarily supplied from the AC adapter, and switches to be from the batteries as a backup in case of a problem such as blackouts.

- To use batteries

Use a flat-bladed screwdriver or a coin to turn counterclockwise the screw on the battery lid at the back of the unit, and then remove the battery lid.

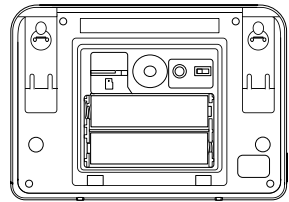

Install new batteries with the correct polarity (+ and -). When reinstalling the battery lid, follow the removal procedure in reverse order.

- To use an AC adapter

Open the USB cap and connect the provided USB cable to the USB port.

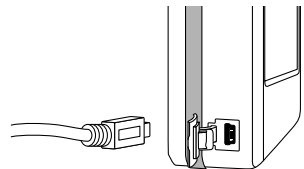

Cautions

- Replacement batteries must be new and of the same type. Mixed use of different types or new and old batteries may cause an explosion or leakage.
- Model SK-L751 and SK-L753 are waterproof. Make sure to firmly attach the battery lid putting the rubber packing in the groove and secure the screw. Otherwise, they fail to be waterproof and result in malfunction.
- Model SK-L751 and SK-L753 lose waterproofness when used with AC adapters, because the port cap is opened. Use it with battery operation at the site where water splashes.

2.2 Connecting the probe

Check the model name of the probe and confirm whether it is appropriate. While observing the correct orientation, insert the probe straight into the connector on the unit, then firmly tighten the probe nut to securely connect the probe. If it is not tightened enough, the waterproofness may be reduced.

Note: Do not twist or bend the sensing portion, or it may cause malfunction.

When Model SK-L751 or SK-L753 is used with the plug-in type probe Model SK-L751-1, connect the probe to CH1. If connected to CH2, another probe cannot be connected to CH1 due to the shape of the plug-in type probe.

If a probe is connected only to CH2, logging cannot be started. Be sure to connect the probe to CH1 first.

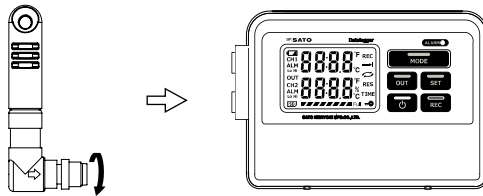

- To Connect a 4-wire sensor not made by us to SK-L753

Loosen the screw on the sensor connector box to open its lid, and screw the sensor to the terminal block inside referring to the carved alphabet. After then close the lid so as not to nip the cords. Fix the box on a wall or a flat surface by screwing in order not to burden the cords on both sides of the box.

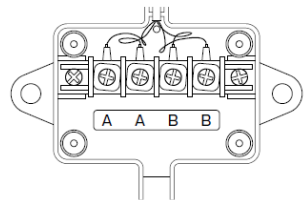

2.3 Connecting to the PC

Connect the unit to the computer using the provided USB cable.

Settings are mainly done through the dedicated software. For details, refer to the software instruction manual.

2.4 Installation

When hanging the unit on a wall, install screws on the wall or pole, pull out the wall-mount hooks from the back of the unit and use them to hang the unit on the wall or pole. Then swing the unit slightly to check that it will not fall. Do not pull the unit mounted on the wall unnecessarily, or it may cause the mounting hooks to come off.

When mounting on the wall, refer to the following dimensions and use M3 screws or the like. Securely install the unit to prevent it from falling.

Main unit

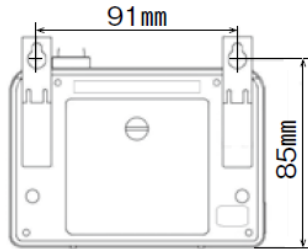

Pt sensor connector box for SK-L753

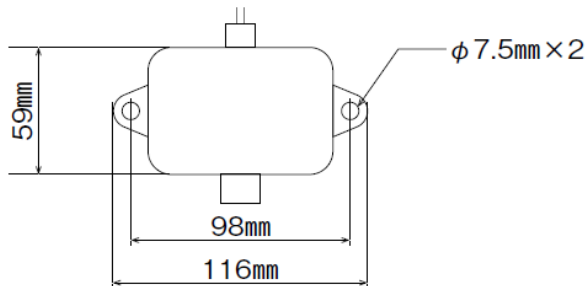

A diameter of the screw holes of the box is 7.5 mm. Using a spacer is advised if needed to fix the box tightly.

3. Functions

Performance

The following operations are performed with each key while each setting is done with dedicated software.

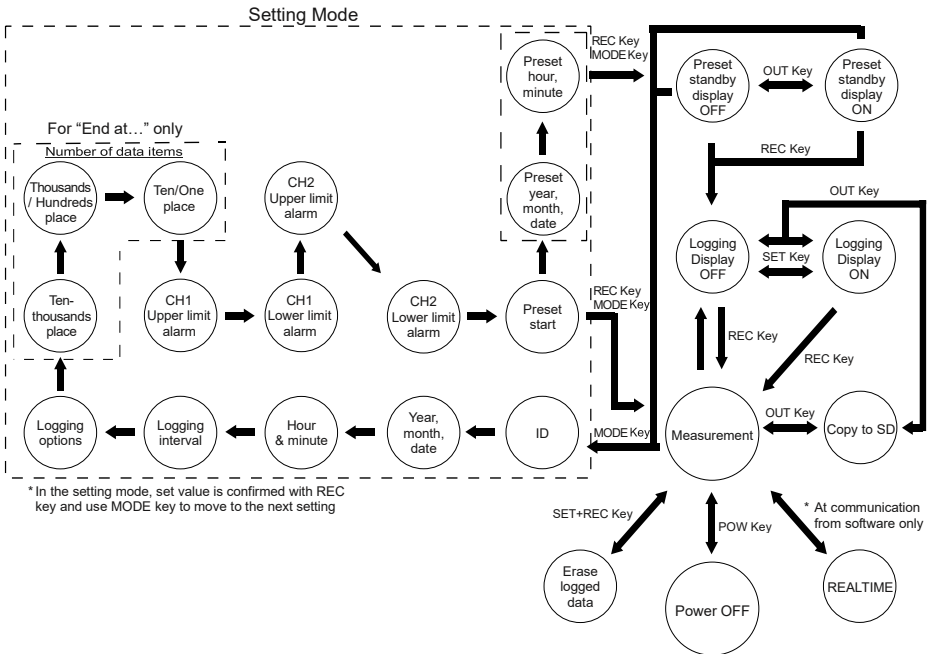

3.1 Measurement mode

Measures the ambient air and displays the results on the LCD.

Connecting the probes and pressing the power key for one second enable the display of measured values, after all indicators flash.

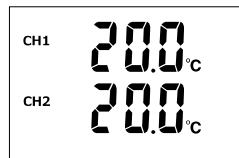
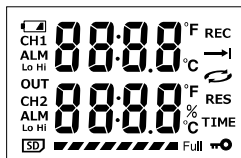

3.2 Setting mode

Used to set various functions.

To enter this mode, press the MODE key while in measurement mode or in standby for preset start.

You can set some functions by using the keys on the unit: alarm (ON/OFF), logging interval, logging option and preset start (ON/OFF). Use the dedicated software to make detailed settings.

If no key is operated for one minute, the unit returns to measurement mode with the setting values at which the REC key was last pressed.

Note: Any change in the setting value is confirmed by pressing the REC key. If the MODE key is pressed instead of the REC key to move to another setting item, the change will not be updated.

- Default Settings

The default settings are as follows. Set each setting with the dedicated software according to your usage.

Item	Setting
ID	000000
Year/Month/Date	2018.1.1
Time	0:00
Logging interval	1 minute
Logging option	Once
CH1 Upper alarm	OFF
CH1 Lower alarm	OFF
CH2 Upper alarm	OFF
CH2 Lower alarm	OFF
Preset start	OFF
Key lock	OFF

Note: For SK-L753, the default date is "2021.1.1" (year, month, day).

- Display of ID

Displays the ID number set in the unit.

The factory default is “id000000”.

Set six digits after “id” in the software. Some characters

are available in addition to numbers. For details, refer to the software.



- Display of time

Displays the year, month, date, hour and minute set in the unit. Before starting the unit for the first time, set the current date and time using the software.

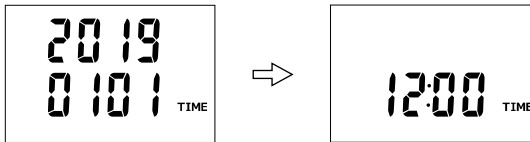

- Display of logging interval

Displays the logging interval set in the unit.

Available logging intervals: 1, 2, 5, 10, 15, 30 seconds, and 1, 2, 5, 10, 15, 30, 60, 90 minutes

It can be also modified by operating the key on the unit. Press the SET key to toggle the logging interval, then press the REC key to fix it.



- Display of logging option

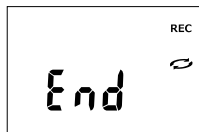
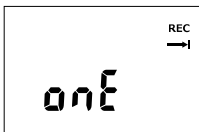

Displays the logging option set in the unit. For each logging option, refer to “Logging Option”.

It can be also set by operating the key on the unit. Press the SET key to toggle the logging option, then press the REC key to choose it.



If “End at ...” is selected, specify the number of data items to log as follows. The upper segment is for setting the ten-thousands digit, and the lower segment is for the thousands and lower digits.

Press the SET key to change the value, and the REC key to fix it and move to the next digit. Long Press of SET key for more than two seconds quickly changes the value.

- Display of alarm setting

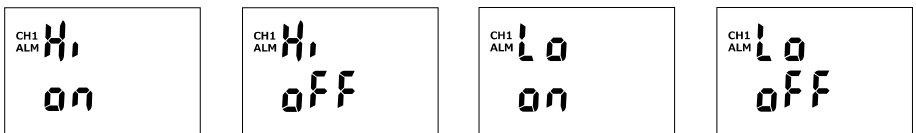

Indicates whether or not the alarm is set. Note that it does not show any alarm value. Alarm values can only be modified via the software.

Pressing the SET key switches the alarm on and off.

When the alarm is on, an indicator “ALM” is lit in measurement mode.

- Display of the preset start setting

Indicates whether or not the preset start is activated. Pressing the SET

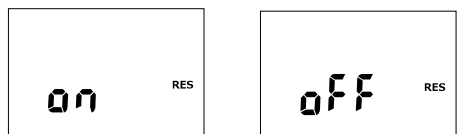

key switches on or off unless the set time is prior to the current time. Note that the preset start date and time can only be modified via the software.

When it is switched on by pressing the SET key and then the REC key, the set date and time is displayed as below.

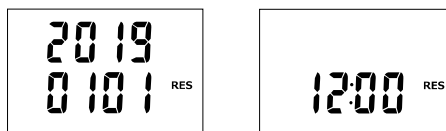

3.3 Logging mode

Logs the measured values according to the specified logging option.

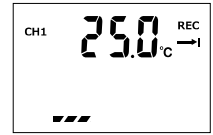
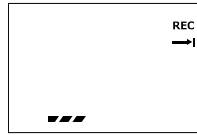

A current value is displayed if the SET key is pressed during this mode.

Note: The battery runs out faster when a current value is kept displayed.

3.4 Copying-to-SD mode

Copies the logged data to a microSD card.

To start copying, press the OUT key for two seconds. When copying is complete, the unit returns to its previous status.

If copying is performed during logging, the unit copies only the data before the key is pressed.



3.5 Standby-for-preset-start mode

The unit enters this mode after the preset start setting is complete and before logging starts.

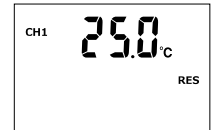

A current value is displayed when the OUT key is pressed once. Repressing the same key turns off its display.

If the MODE key is pressed during this mode, the unit enters setting mode and the preset start is automatically turned off. To turn it on again, configure it in setting mode of the unit or via the software.

Note: Preset start removes previously logged data automatically. Save necessary data in advance.

If any abnormality such as low battery or probe disconnection is detected while in standby mode, the unit automatically ends logging after recording once at the preset start time. Make sure that the probes and batteries are in good condition.

3.6 Deleting-logged-data mode

Within this mode, press the REC key for two seconds while holding the SET key to remove logged data. After removal, the unit returns to the previous mode.

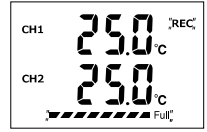

3.7 Real-time mode

Measured values are transmitted to a connected PC in real time in this mode. Controllable only from the software.

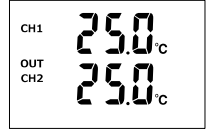

4. Operation procedure

Operation procedure of the datalogger is as follows. Perform each setting and operation with the dedicated software.

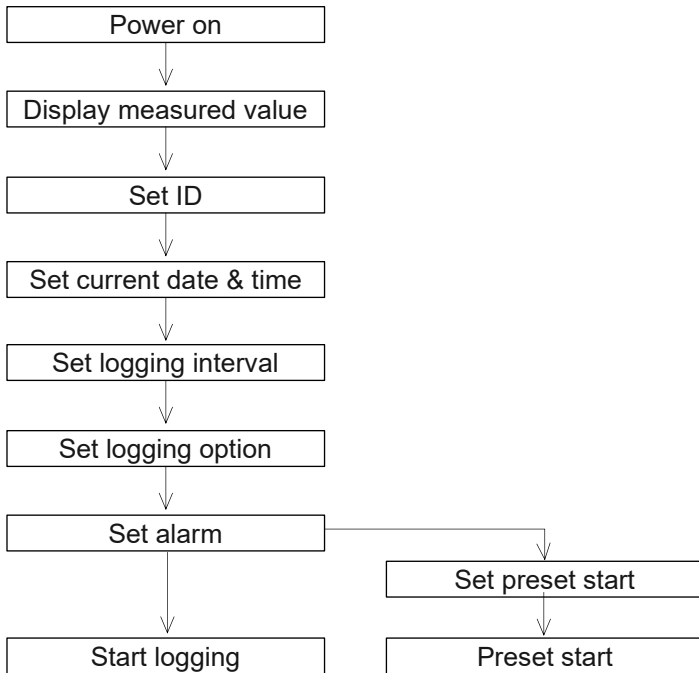

Available operations on the datalogger and the software:

Action	Datalogger	Software
Turning the datalogger on/off	Yes	No
Setting of ID	No	Yes
Setting of year, month and date	No	Yes
Setting of time	No	Yes
Choosing logging interval	Yes	Yes
Choosing logging option	Yes	Yes
Alarm on/off	Yes	Yes
Setting of alarm setting value	No	Yes
Preset start on/off	Yes	Yes
Setting of preset date and time	No	Yes
Shifting to real-time mode	No	Yes
Key lock	Yes	Yes
Erasing collected data	Yes	Yes
Copying to microSD	Yes	No

5. Logging option

The datalogger has four logging options. Select either one as needed.

- Once

The unit keeps logging until the memory becomes full, then stops when the number of logged data reaches 16000.

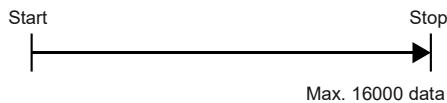

- Repeatedly

The unit overwrites the existing data from the beginning once the memory becomes full.

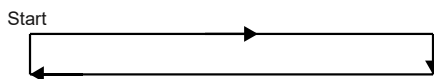

- End at ...

The number of data items to be logged can be specified in advance between 1 and 16000.

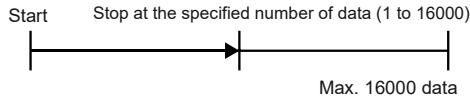

- By Page

The memory on the unit is partitioned into four pages so that it can log data from multiple sites in sequence.

Each page can contain up to 4000 data items.

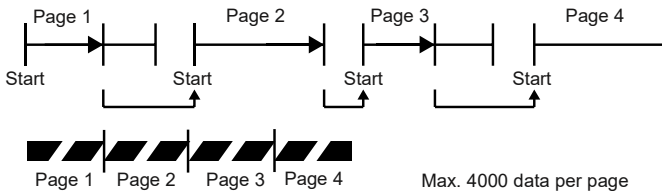

Number of lit segments of the memory bar and number of logged data:

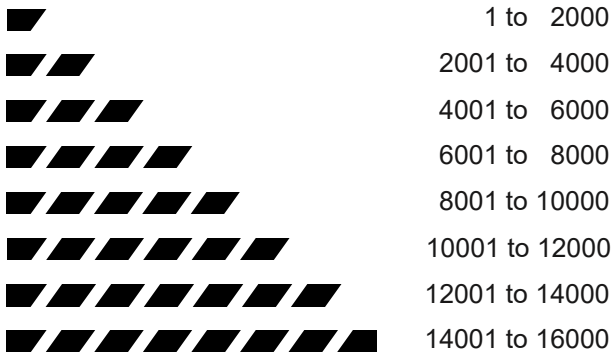

When the number of logged data reaches 16000, an indicator "Full" is lit on the right of the memory bar.

Note: Pressing the REC key for two seconds erases remaining logged data and restarts logging. Be sure to download the data or save it to a microSD. Also, press the same REC key for two seconds to stop logging. An indicator "REC" turns off to show that the logging is ended.

6. Alarm operation

If the measured value exceeds or falls from the upper or lower alarm setting value, the indicators of “ALM” and “Hi” or “Lo” will flash and the alarm light will be lit. Then, when the measured value falls back within the range of the setting values, the indicator and the light go off.

To turn off alarm actions, press the MODE key while holding the SET key.

Note: The alarm does not work if the unit is not measuring, that is, when the unit is in standby for preset start or when the unit is in a setting mode.

The alarm setting is turned off and the set value returns to the default when the probe is disconnected.



7. Key lock function

The datalogger has a function to prevent misoperation while in logging or in standby for preset start.

To enable it, press SET key for two seconds when in measurement mode or in standby for preset start. The key lock indicator will then be lit on the display and the operation of keys other than the SET key will be disabled.

To unlock it, press the SET key again for two seconds.

8. AC Adapter

We offer a dedicated AC adapter (Catalog No. 8229-50). If you use an AC adapter other than this, select the one with 1A/5VDC, USB Mini-B output.

9. Error Codes

The error codes below are shown on the display section when needed.

Code	Definition	Solution
H ₁	Measured value exceeds the display range.	Use within the measuring range.
Lo	Measured value is under the display range.	
Er	Measured value is out of the display range and reaches an alarm set value, or the probe is out of order.	Use within the measuring range. If the problem remains, the probe may be in failure. Contact us or the dealer.
Er 0	An abnormal signal, or noise is input when the power turns on.	Restart by pressing the reset switch in the battery compartment. If the problem remains, the probe may be in failure. Contact us or the dealer.
Er 1	A sensor signal is not read though the probe is connected.	Turn the power off and on. If the problem remains, the probe may be in failure. Contact us or the dealer.
Er 2	No probe is connected, or the probe is out of order. As for SK-L753, the probe is connected wrongly.	Confirm the connection and then turn the power on. If the code Er2 remains, the probe may be in failure. Contact us or the dealer.
Er 3	Tried to copy data to microSD card when no data exists, or no card is inserted.	Check if logged data exists through the data memory bar, and if microSD card is inserted.
Er 4	Incorrect probe is connected.	For SK-L751 and SK-L753, connect a temperature probe. For SK-L754, connect a temperature/humidity probe.
Er 5	Preset date and time are prior to the current date and time.	Change the preset date and time with using the dedicated software.
Er 6	Tried to change the logging option when data exists in the unit.	After erasing logged data, change the logging option.

10. Specifications

Model	SK-L751 Temperature Measurement Type	SK-L754 Temperature/Humidity Measurement Type
Cat. No.	8800-00	8870-00
Measuring range	Depends on probes connected ⁴	
Resolution	0.1°C	0.1°C / 0.1%rh
Display Accuracy	±0.2°C (0 to 40°C) ±0.3°C (other)	Temp.: ±0.2°C (0 to 40°C) ±0.3°C (other) Humidity: ±0.2%rh (0 to 40°C) ±0.3%rh (other)
Display sampling	Approx. 1 second	
Display	Temperature/humidity alarm (ALM), logging option, status display (REC/RES), memory indicator (in bars), SD memory, low battery indicator, key lock mark, error codes, each setting value	
Measuring channel	2 channels for temperature	1 channel each for temperature and humidity
Memory capacity	16000 data items for each channel	
Logging interval	1, 2, 5, 10, 15, 30 seconds; 1, 2, 5, 10, 15, 30, 60, 90 minutes	
External memory	MicroSD/SDHC up to 32 GB ¹	
Operating ambient	-10.0 to 60.0°C, lower than 85%rh without condensing	
Storage ambient	-10.0 to 60.0°C, lower than 85%rh without condensing	
Power	Two alkaline AA batteries or an AC adapter	
Battery life at 23°C ²	In measurement mode: approx. 500 hours In logging mode: until 16000 data items are logged with any logging interval as long as LCD is off	
Dimensions	114 (W) x 80 (H) x 35 (D) mm excluding protrusions	
Weight	232 g including batteries	227 g including batteries
Waterproofness	IP65 when w/-sensor-cord-type probe is connected	N/A
Accessories	CD-ROM of data analysis software and real-time software, USB cable, 2 alkaline AA batteries, English manual	

Remarks

1. Only FAT32-formatted cards supported. NTFS not supported.

The following cards are tested at our factory:

RMSD-Y016U1A (16 GB), RMSD-Y032U1A (32 GB) by Buffalo

MF-RUMSD16GL (16 GB), MF-RUMSD32GL (32 GB) by Elecom

SDSDQUL-16G-J35A (16 GB), SDSDQUL-32G-J35A (32 GB) by SanDisk

Model	SK-L753 Pt Sensor Temperature Measurement Type
Cat. No.	8850-00
Measuring range	-99.9 to 600.0°C
Resolution	0.1°C
Display Accuracy	±0.2°C (0 to 40°C) ±0.3°C (other)
Display sampling	Approx. 1 second
Display	Temperature alarm (ALM), logging option, status display (REC/RES), memory indicator (in bars), SD memory, low battery indicator, key lock mark, error codes, each setting value
Measuring channel	2 channels for temperature
Memory capacity	16000 data items for each channel
Logging interval	1, 2, 5, 10, 15, 30 seconds; 1, 2, 5, 10, 15, 30, 60, 90 minutes
External memory	MicroSD/SDHC up to 32 GB ¹
Operating ambient	-10.0 to 60.0°C, lower than 85%rh without condensing
Storage ambient	-10.0 to 60.0°C, lower than 85%rh without condensing
Power	Two alkaline AA batteries or an AC adapter
Battery life at 23°C ²	In measurement mode: approx. 500 hours In logging mode: until 16000 data items are logged with any logging interval as long as LCD is off
Dimensions	114 (W) x 80 (H) x 35 (D) mm excluding protrusions
Weight	Main unit: 230 g including batteries Sensor connector box: 103 g
Waterproofness	IP65 when dedicated probes for SK-L753 are connected
Accessories	CD-ROM of data analysis software and real-time software, Pt sensor connector box for SK-L753, USB cable, 2 alkaline AA batteries, English manual

2. Attached batteries are for test purpose and may last shorter.
3. The specifications and appearance are subject to change without notice for improvement purpose.
4. For the specifications of probes, refer to the manual attached with each probe.

WARRANTY POLICY

Our products are warranted to be free from defects in materials and workmanship for a period of one year from date of delivery. If repair or adjustment is necessary and has not been the result of misuse or force majeure within the one-year period, please return the units on freight prepaid basis and correction of the defect will be made without charges. We alone will determine if the product problem is due to deviations or customer misuse.

Out-of-warranty products will be repaired on charge basis.

Warranty during transportation

The warranty during transportation only applies to the products that we arrange the shipment. The case that the products had been purchased in domestic and were sent to overseas by the purchaser is out of warranty.

Return of items

Authorization must be obtained from us before returning items for any reason. When applying for authorization, please include data regarding the reasons the items are to be returned.

SATO KEIRYOKI MFG. CO., LTD.

3-4, Kanda-kajicho, Chiyoda-ku, Tokyo 101-0045 JAPAN

TEL: +81 3-3254-8117 FAX: 3-3254-8123

URL: <https://www.sksato.co.jp/en/>