



Features and Benefits

- Latest electro-chemical sensor technology with a lifetime up to 10 years
- Easy installation with LED indication
- Supports 2-wire loop powering or 3-wire installation
- Built-in circuitry diagnostics

Technical Overview

Using latest electro-chemical sensor technology with high repeatability and sensitivity to Carbon Monoxide gases in the ambient air, this sensor ensures accurate and maintenance free operation in residential and commercial environments. The sensor modules have a catalytic ability to ensure years of operation with no chance of sensor life degradation as known from other electro-chemical sensors.

IMPORTANT The sensor is not designed, manufactured or intended for use or re-sale as control or monitoring equipment in environments requiring life safety performance, in which the failure of the sensor could lead directly to death, personal injury, or severe physical or environmental damage. Sontay and its suppliers specifically disclaim any express or implied warranty of fitness for life safety.

Product Codes

GS-CO-D Duct CO & Temperature transmitter 0-500ppm

Suffixes (replace -T with type)

-T Direct resistive temperature output *

Thermistor types:

A (10K3A1)	B (10K4A1)	C (20K6A1)
H (SAT1)	K (STA1)	L (TAC1)
M (2.2K3A1)	N (3K3A1)	P (30K6A1)
Q (50K6A1)	S (SAT2)	T (SAT3)
W (SIE1)	Y (STA2)	Z (10K NTC)

Platinum types:

D (PT100a)	E (PT1000a)
------------	-------------

Nickel types:

F (NI1000a)	G (NI1000a/TCR (LAN1))
-------------	------------------------

Interface Options (add to part code)

-TR Custom temperature range between -20 and +50°C

-5V Output 0-5Vdc (instead of 0-10Vdc)

Specification

Outputs:	3-wire	0-10Vdc (0-5V for -5V) or 4-20mA
	2-wire	4-20mA, loop powering
	(optional -T)	PTC/NTC resistive sensing element
Power Supply:		24Vac/dc ±10% (3-wire)
		24Vdc ±10% (2-wire)
Supply current:		30mA (3-wire) max.
Electrical connections		Pluggable spring loaded terminal block min. 0.2mm ² , max. 1.5mm ²
Output ranges;	CO	0 to 500ppm
	Temperature	-20 to +50°C
Environmental:	Housing:	-30 to 60°C
		5 to 95% non-condensing
	Media:	-10 to +50°C
Housing:	Material	PC/GF (Halogen free, flame retardant & UV stabilized)
	Dimensions	123 x 103 x 54mm
Probe:	Material	Probe PVC - End cap Delrin
	Dimensions	210 x 20mm dia.
Protection		IP65
Country of origin		UK
Conformity		EMC, CE & UKCA Marked

WEEE Directive:



At the end of the products useful life please dispose as per the local regulations. Do not dispose of with normal household waste. Do not burn.



Sensor Characteristics

Carbon Monoxide

Type	Electrochemical sensor
Accuracy	Typical $\pm 7\%$ fsd.
Measurement range	0-500ppm
Baseline offset	$< \pm 10$ ppm equivalent
Response time	max. 60 seconds (t90%)

Temperature

Measurement range	-20 to +50°C
Accuracy (20 to 40°C)	$\pm 0.5^\circ\text{C}$
Long term stability	$< 0.02^\circ\text{C}$ p.a.

Optional Passive Output

Type	Resistive PTC & NTC types
Accuracy:	
Thermistor	$\pm 0.2^\circ\text{C}$ 0 to 70°C
Platinum types	$\pm 0.2^\circ\text{C}$ @ 25°C
Nickel types	$\pm 0.4^\circ\text{C}$ @ 25°C

Installation



Antistatic precautions must be observed when handling these sensors. The PCB contains circuitry that can be damaged by static discharge.

Note: Sontays range of CO sensors are not to be used in domestic applications

1. Select a location in the duct where dust & contaminants are at a minimum (i.e. after filters etc.) and which will give a representative sample of the prevailing air condition.
2. Fix the housing to the duct with appropriate screws.
3. Release the snap-fit lid by gently squeezing the locking tab and feed the cable through the waterproof gland and terminate the cores at the terminal block. Leaving some slack inside the unit, tighten the cable gland onto the cable to ensure water tightness.
4. If the sensor is to be mounted outside, it is recommended that the unit be mounted with the cable entry at the bottom. If the cable is fed from above then into the cable gland at the bottom, it is recommended that a rain loop be placed in the cable before entry into the sensor.
5. Set the switch on the PCB either to the 3-wire or 2-wire position. Please refer to "Selecting output mode and LED indication" for more details. Snap shut the lid after the connections have been made.

IMPORTANT Do not alter the switch position while sensor is powered up. Do not select 2-wire if a 0v connection (3-wire) is made. Permanent damage to the sensor or BMS controller may result.

IMPORTANT Ensure the Terminal Block is fitted the correct position and direction. The cable entry faces the centre of the sensor.

6. Connect all sensor outputs to the controller inputs or to the device, the sensor output(s) are connected to.
7. Before powering the sensor, ensure that the supply voltage is within the specified tolerances.

IMPORTANT Make all electrical output connections before applying the supply voltage. If the sensor is not connected in this sequence, damage may be caused to the input circuitry of the controller or device the sensor output(s) are connected to.

8. Allow 3 minutes before checking functionality, and at least 30 minutes before carrying out pre-commissioning checks. This will allow the electronics time to stabilise. The CO electronics require at least 24h continues operation in clean air before any accuracy tests can be performed.

Terminal Block:

For easier installation, the terminal block can be detached from the PCB.

When used with ferrules it doesn't require any tools to release the spring loaded terminal block. When used with stranded cable, push in the orange latch to compress the spring load. Feed in the wire and release the spring to secure the wire connection.

IMPORTANT Make sure the Terminal Block is fitted the correct position and direction. The cable entry faces the centre of the sensor.

Electrical Connections:

- 24V** Supply 24Vac/dc
- 0V** Supply 0V (Common 0V)
- OP1** CO output
- OP2** Temp. output
- OP3** Not used
- 0V** Not used
- TH1** Direct Thermistor output (-T only)
- TH2** Direct Thermistor output (-T only)

LED Indication:

- LOOP Blue
- 4-20mA Yellow
- 0-10V Green
- ERROR Red

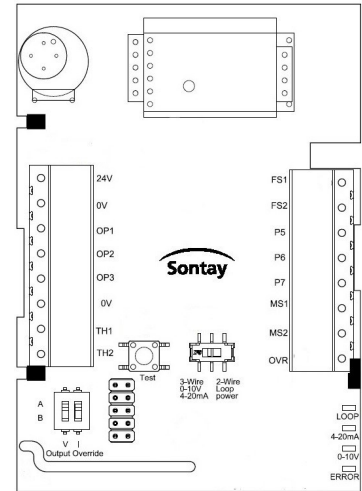

3-wire, 0-10Vdc / (0-5Vdc optional):

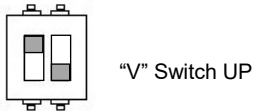
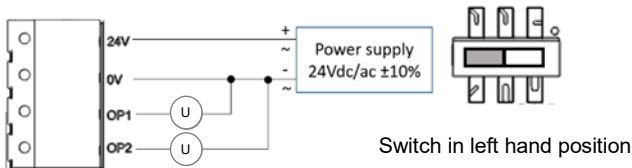

3-wire, 4-20mA:

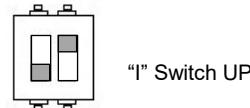
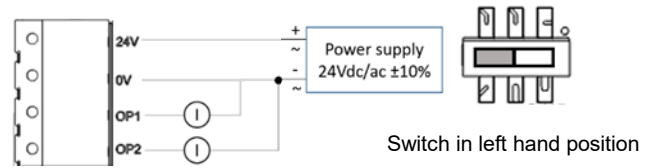

2-wire, 4-20mA:

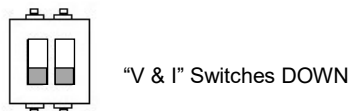
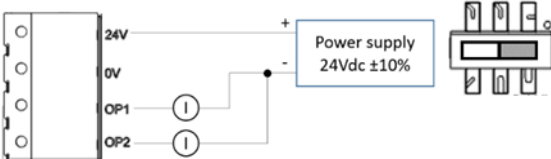

-T, direct resistive output:



See next page for further information on setting output modes.

Selecting output mode and LED indication:

IMPORTANT Do not alter the switch position while sensor is powered up. Do not select 2-wire if a 0v connection (3-wire) is made. Permanent damage to the sensor or BMS controller may result.

3-wire connection:

Ensure there is no power to the sensor before changing the switch. Set the switch in the left hand position. The sensor automatically sets the outputs to 0-10V or 4-20mA based on the resistive load on the outputs. All outputs MUST be connected to the same type of load:

- If ALL the loads are $>2k\Omega$, all the outputs will be set to 0-10Vdc and the green 0-10V LED will light.
- If ALL the loads are $>50\Omega$ and $<550\Omega$, all the outputs will be set to 4-20mA and the yellow 4-20mA LED will light.
- If ANY of the loads are $<50\Omega$ or >550 and $< 2k\Omega$, all the outputs will be switched off and the red ERROR LED will light.

Auto detection can be overridden via 2-way DP switch situated on the left hand side of the PCB.

Set the auto detection 2-way DIP switch to the **3-wire** position

Set the override 2-way switch to:

- Voltage (0-10V/0-5V) switch DIP1 (V) to ON
- Current (4-20mA) switch DIP2 (I) to ON

The ON position for the switch is labelled on the switch itself.

Example, if you set the V switch (left) to OFF and the I switch (right) to ON, the device will force 3-wire current mode. The device is also set up to detect a change on these switches and reboot itself after 5 seconds - the error LED will flash during this period then the yellow 4-20mA LED will illuminate.

2-wire connection:

Ensure there is no power to the sensor before changing the switch and do not connect 0V. Set the switch in the right hand position. All outputs MUST be connected. The blue LOOP LED will light.

The LEDs will switch off after 15 minutes.

Self-Test Button:

The self-test button helps the installer to validate the wiring for each output and helps to commission the system.

When self-test button is pushed it cycles all outputs as follows: 0%, 50%, 100%, normal operation. After 30 seconds in any mode the system resets to normal operation.

When self-test button is held for more than 3 seconds, it sets all outputs to 50%, when released the outputs return to normal operation.

Dimensions:

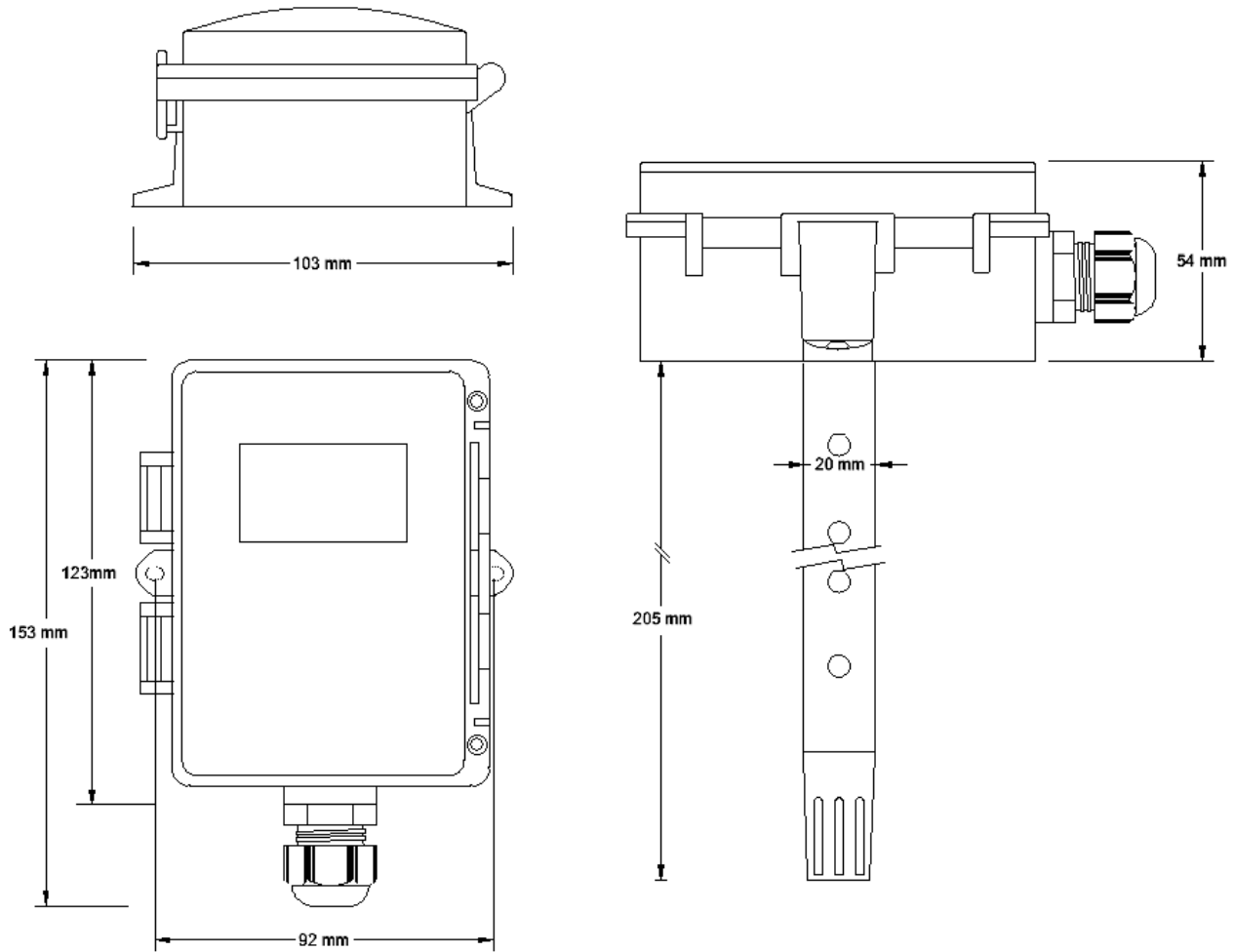

Revision History:

Rev.	Description of change	Page No.	Date
7.5	Output type override & dimensions	3, 4 & 5	25/07/2022
7.4	UKCA added	1	30/09/2021
7.3	Additional warnings on domestic use	1	19/06/2020
7.2	Change over of outputs, OP1 & OP2	3	14/04/2020
7.1	LED status	4	31/01/2020
7.0	New product	All	24/09/2019

Whilst every effort has been made to ensure the accuracy of this specification, Sontay cannot accept responsibility for damage, injury, loss or expense resulting from errors or omissions. In the interest of technical improvement, this specification may be altered without notice.