

METRISO | 3000

High Ohmic Resistance Tester for resistance point-to-point, resistance to ground, surface and volume resistance measurements

3-349-644-03
2/2.13

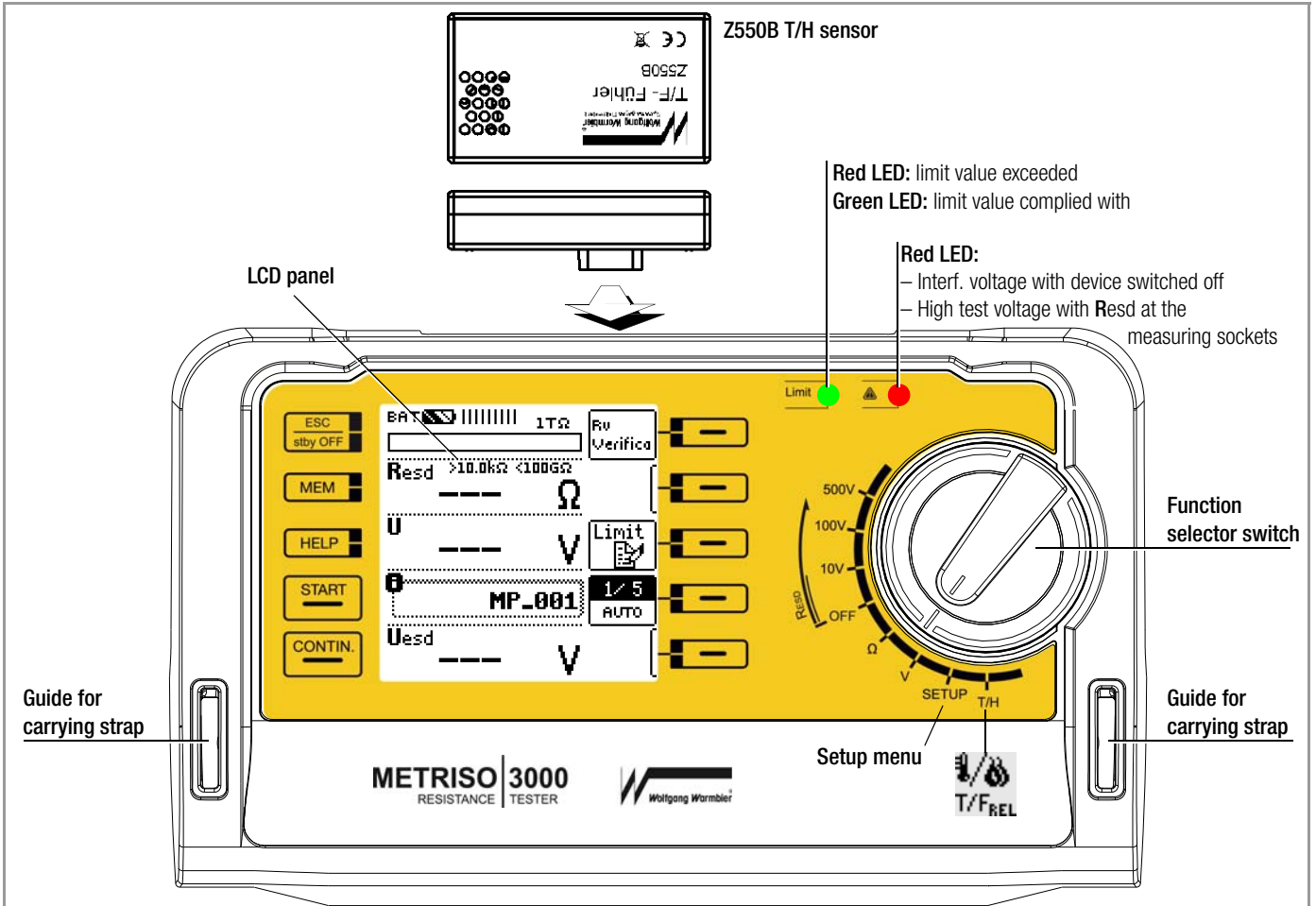



Control Panel

Softkeys

- Parameter selection
- Limit value specification
- Entry functions
- Memory functions

Fixed Function Keys

ESC: Exit submenu / activate instrument from standby state

MEM: Key for memory functions

HELP: Access context sensitive help

START: Start measurement

CONTIN: Continuous measurement

LEDs → section 4.3

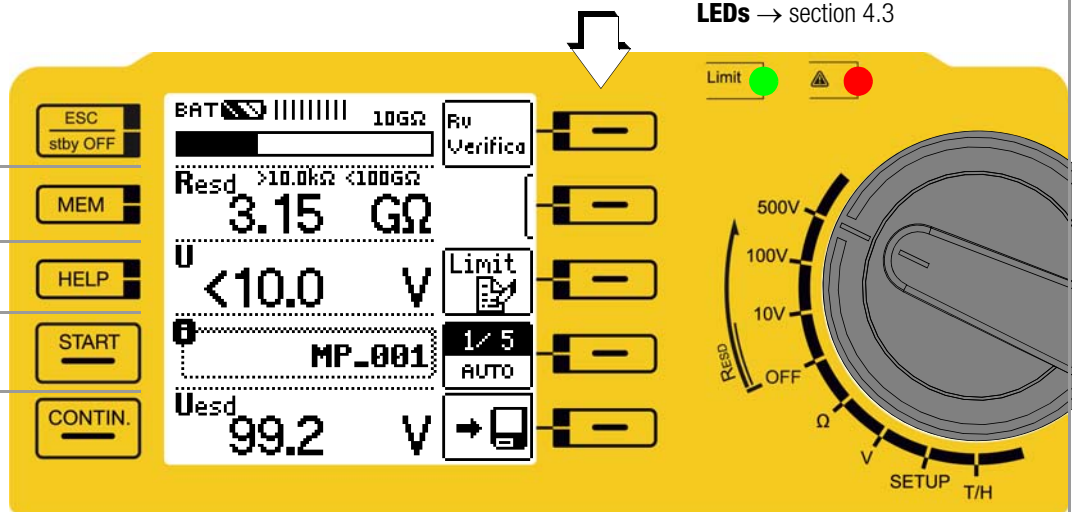

Batteries, Fuses

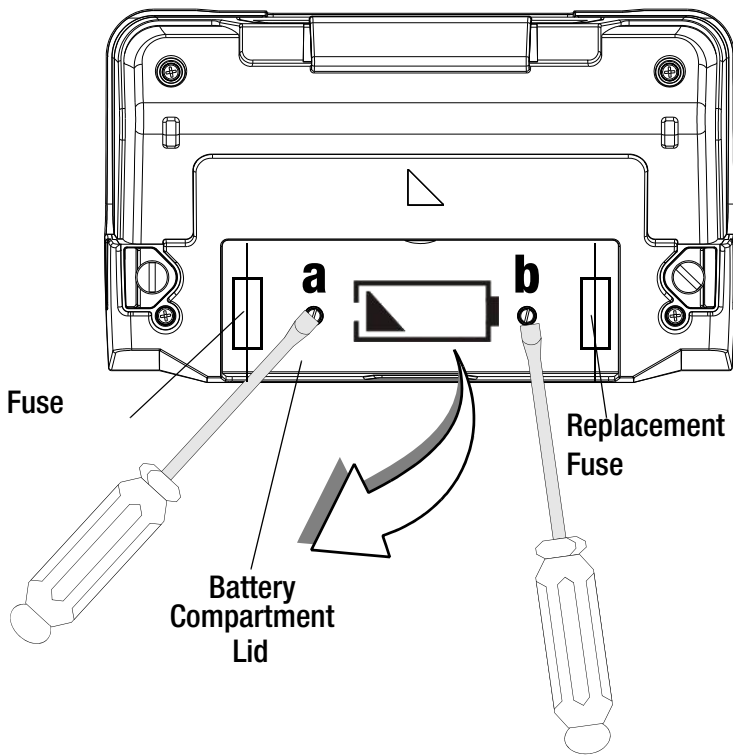

Inserting the Battery Holder (side view)

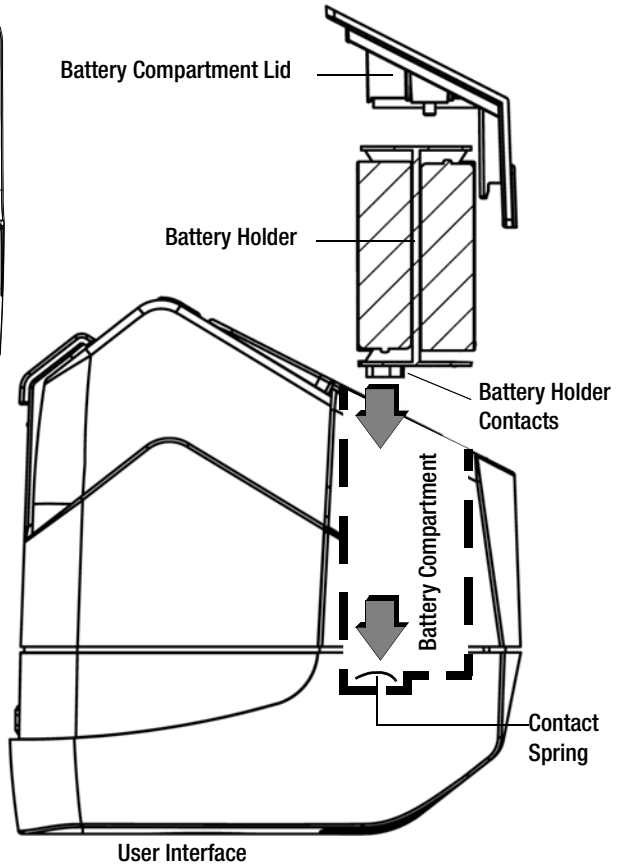

Measuring Connections

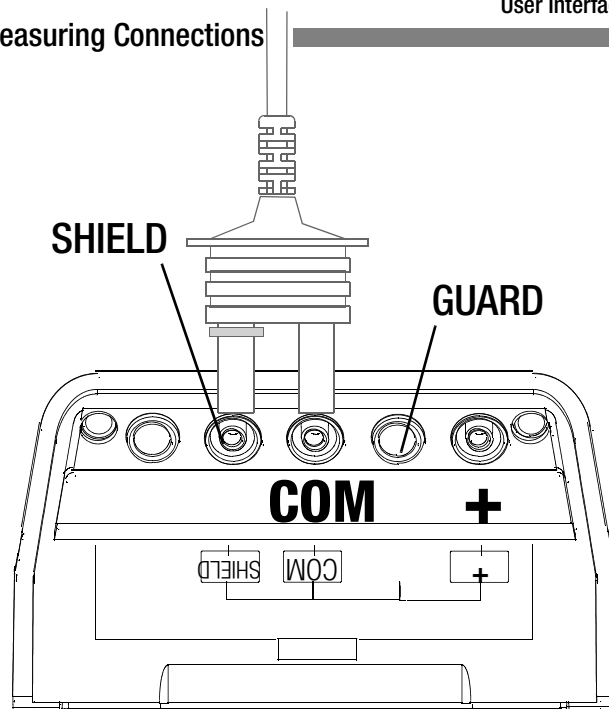

Charger Socket, Interfaces

These connections are located under a protective rubber flap.

Socket for Z502R charger

Caution!

Only rechargeable batteries may be inserted when the charger is connected. The test instrument must remain off during the charging process.



Port for connecting Barcode/Rfid reader and temperature-humidity adapter

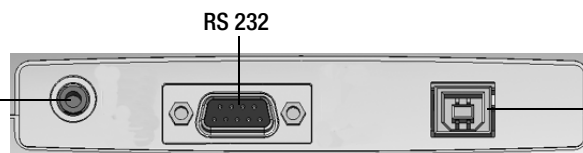

RS 232



USB slave for PC connection

Overview of Device Settings and Measuring Functions Relative to Rotary Switch Setting

Switch Setting, Description as of	Pictograph	Device Settings Measuring Functions
RES D		RES D Resistance U Voltage at the test probes Uesd Permanently set measuring voltage
page 14		
Ω		R Resistance measurement
page 19		
V		U Voltage measurement
page 13		
SETUP		Tests: LCD pixel display LCD pixel display All pixels off Green limit LED Red limit LED Acoustic signal
		Battery test Ubat
		Date/time CULT= LANGUAGE (German, English)
		Brightness SET on: On-time, LCD and tester
		Contrast GOME SETTING Default settings
		Device type Serial number Software version Hardware version Calibration date Adjustment date
page 8		

Display Panel

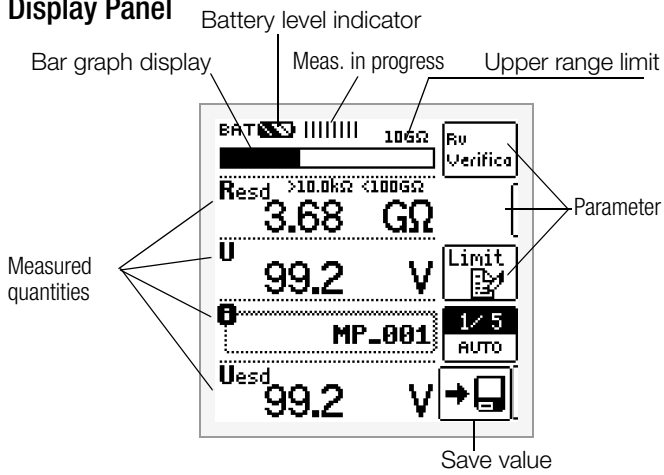

Measuring Status

Measurement in progress: Bars moves from left to right.

Measurement on pause: Bars are static.

Battery Level Indicator

BAT Battery full **BAT** Battery weak

BAT Battery OK **BAT** Battery (nearly) depleted
U < 8.5 V

Memory Occupancy Display

MEM Memory full > transfer data to PC!

MEM Memory half full

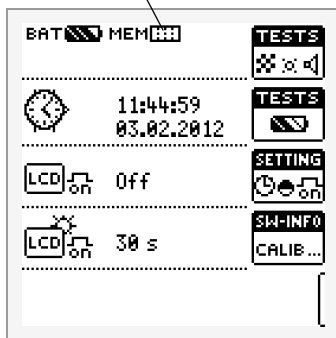

These operating instructions describe a tester with the following software version: SW-VERSION (SW1) 00.06.75.

METRISO 3000 Measuring Kit includes:

- 1 High ohmic resistance meter with integrated USB interface
- 1 Set of measurement cables
- 1 Z550B plug-on temperature and atmospheric humidity sensor
- 2 probes according to IEC 61340-4-1/61340-2-3
- 1 hand-held probe according to IEC 61340-4-5
- 1 USB interface cable (3-620-306-01)
- 1 Printed, short-form operating instructions
- 1 Conductive carrying case with dissipative foam
- 1 CD ROM with the following content:
ETC evaluation software for the PC,
operating instructions in PDF format in
available languages (German, English and French)

1	Applications	6	11	Characteristic Values	25
1.1	Overview of Measuring Instrument Performance Features	6	12	Maintenance	27
2	Safety Features and Precautions	7	12.1	Firmware Revision and Calibration Information	27
3	Initial Start-Up	7	12.2	Rechargeable Battery Operation and Charging	27
3.1	Battery Test	7	12.2.1	Charging Procedure with the Z502R Charger (accessory: 7100.3000.Z502R)	27
3.2	Installing or Replacing Batteries	7	12.3	Fuses	27
3.3	Charging the Batteries in the Tester	7	12.3.1	Fuse	27
3.4	Device Settings – SETUP	8	12.3.2	Electronic Fuse	27
4	General Operation	11	12.4	Housing	28
4.1	Connecting the Instrument	11	12.5	Return and Environmentally Sound Disposal	28
4.2	Switching On, Monitoring and Switching Off	11	13	Appendix	29
4.3	Optical Indicators	11	13.1	Error Messages	29
4.4	Measurement Value Display and Memory	11	13.2	Optional Accessories (not included)	30
4.5	Setting Measuring Parameters per ESD Standards	12			
4.6	Setting Measuring Parameters using Limit Value Specifications as an Example (example: setting the “lower limit value”)	12			
5	Measuring Direct and Alternating Voltage	13			
6	ESD Measurements	14			
6.1	Discharging the Device Under Test	15			
6.2	Measuring Resistance to ground R_g or R_{gp} according to IEC 61340-4-1	16			
6.3	Measuring Resistance through a person to ground $R_{g\text{ System}}$ or $R_{gp\text{ System}}$	16			
6.4	Measuring Point-to-Point Resistance	17			
6.4.1	Measuring Point-to-Point Resistance R_{p-p} with 2 Measuring Probes according to IEC 61340-2-3	17			
6.4.2	Measuring Surface Resistance R_S of Packaging Materials with a Ring Probe according to IEC 61340-2-3	17			
6.5	Measurement of Volume Resistance R_V according to IEC 61340-2-3	18			
6.6	Measurement with the GUARD Terminal	18			
7	Test Resistor for Resistance Measurement for Checking the High Resistance Tester	18			
8	Measuring Resistance – Ohm Function	19			
9	Temperature and Humidity Measurement with the Z550B T/F Adapter	19			
10	Database	20			
10.1	Creating ESD Control Elements, General	20			
10.2	Transferring Structures	20			
10.3	Creating a Structure in the Test Instrument.	20			
10.3.1	Creating Structures (example for floor covering, FLOOR 01)	21			
10.3.2	Searching for Structural Elements	22			
10.4	Saving Data and Generating Reports	23			
10.4.1	Use of Barcode Scanners and RFID Readers	24			

1 Applications

The **METRISO 3000** measuring and test instrument allows quick and efficient testing and documentation of ESD protective measures in the EPA (electrostatic protected area).

The test instrument is suitable for:

- The selection of ESD materials
- Installation of selected protective measures
- Periodic inspection of protective measures

With the help of the METRISO 3000, you can perform all relevant ESD measurements in accordance with IEC 61340-4-1, IEC 61340-2-3 and IEC 61340-4-5.

Thanks to the USB data interface integrated into the **METRISO 3000**, stored measured values can be transmitted to a PC, where they can then be printed and archived. This is of special significance where product liability is concerned.

The following measurements and tests can be performed with the **METRISO 3000**:

- Resistance to ground, point-to-point and surface resistance, as well as volume resistance (with special measuring probes)
- Temperature and atmospheric humidity (with special sensor included in **METRISO 3000** Measuring Kit no. 7100.3000.MK)

1.1 Overview of Measuring Instrument Performance Features

METRISO	3000
Article No.	M550A
Measurement	
R_{ESD}	U = 10, 100, 500 V ✓
R	1 Ω ... 10 kΩ ✓
U	0 ... 500 V ✓
Display Functions	
Backlit display	✓
Limit value LED (green/red) for: additional acoustic signal, limit values are adjustable (see section 4.3)	R_{ESD}
LED for dangerous contact voltage (when switched off)	✓
Battery level display	✓
Special Functions	
Discharge capacitive devices under test	✓
Safety shutdown (UBatt < 8 V)	✓
Data storage at the instrument	✓
ETC software for data acquisition, data management and reporting	✓
Features	
Measuring category: CAT II, 600 V	✓
Test resistance: 10 MΩ	✓
Connections: charging socket, USB port (slave), RS 232 port	✓
Factory calibration certificate	✓

2 Safety Features and Precautions

The electronic measuring and test instrument is manufactured and tested in accordance with safety regulations IEC/EN 61010-1/VDE 0411-1 and EN 61557. When used for its intended purpose, safety of the operator, as well as that of the instrument, is assured.

Read the operating instructions thoroughly and carefully before using your instrument. Follow all instructions contained therein.

The measuring and test instrument may not be placed into service:

- If the battery compartment lid has been removed
- If external damage is apparent
- If connector cable or measuring adapters are damaged
- If the instrument no longer functions flawlessly
- After extraordinary stressing due to transport
- After a long period of storage under unfavorable conditions (e.g. humidity, dust or extreme temperature)

Data Backup

We advise you to regularly transfer your stored data to a PC in order to prevent potential loss of data in the test instrument.

We assume no responsibility for any data loss.

We recommend ETC software (Electric Testing Center) for backing up, processing and managing data.

Meanings of Symbols on the Instrument



Warning concerning a point of danger (attention, observe documentation!)



Protection class II device



Charging socket for extra-low direct voltage (Z502R charger)

Attention!

Only rechargeable batteries may be inserted when the charger is connected.



EC mark of conformity



The device and included batteries may not be disposed of with the trash.

3 Initial Start-Up

3.1 Battery Test

Four different battery symbols, ranging from fully depleted to fully charged, continuously indicate the momentary charge level in the upper left-hand corner of the display

If battery voltage has fallen below the allowable lower limit, the pictograph shown at the right appears. The instrument does not function if the batteries have been depleted excessively, and no display appears.



3.2 Installing or Replacing Batteries

New batteries must be inserted for initial start-up, or **if only 1 filled segment remains in the battery symbol.**



Attention!

Before opening the battery compartment (see page 5 for location), disconnect the instrument from the measuring circuit (mains) at all poles.

Eight 1.5 V size AA batteries in accordance with IEC LR 6 are required for operation of the high-impedance measuring instrument. Use new alkaline manganese batteries only.

Rechargeable NiCd or NiMH batteries may also be used. These can be charged externally or by connecting the Z502R charger to the test instrument. We recommend rechargeable NiMH batteries. Always replace batteries in complete sets.

Dispose of batteries in an environmentally sound fashion.

- ⇒ Loosen both slotted screws for the battery compartment lid on the back, and remove the lid.
- ⇒ Remove the battery holder and insert eight 1.5 V size AA batteries with correct polarity in accordance with the symbols.



Attention!

Make sure that **all of the batteries are inserted with correct polarity**. If just one battery is inserted with reversed polarity, it will not be recognized by the instrument and may result in leakage from the batteries.

- ⇒ Push the battery holder into the battery compartment such that the battery holder's contacts touch the contact springs at the bottom of the battery compartment (see drawing on page 3).
If the battery holder is not inserted as specified, the instrument cannot be supplied with power.
- ⇒ Replace the battery compartment lid and retighten the screws.



Attention!

The instrument may only be placed into service if the battery compartment lid is securely fastened!

3.3 Charging the Batteries in the Tester



Attention!

Use only the Z502R charger (available as an accessory) to charge batteries which have already been inserted into the test instrument.

Make sure that the following conditions have been fulfilled before connecting the charger to the charging socket:

- Rechargeable batteries have been installed with correct polarity (not standard batteries)
- The test instrument has been disconnected from the measuring circuit at all poles
- The instrument must remain off during charging.

Refer to section 12.2.1 with regard to charging batteries which have been inserted into the tester.

If the batteries or the battery pack have not been used or recharged for a lengthy period of time (> 1 month), thus resulting in excessive depletion:

Observe the charging sequence (indicated by the LED at the charger) and initiate a second charging sequence if necessary (disconnect the charger from the mains and from the test instrument to this end, and then reconnect it).

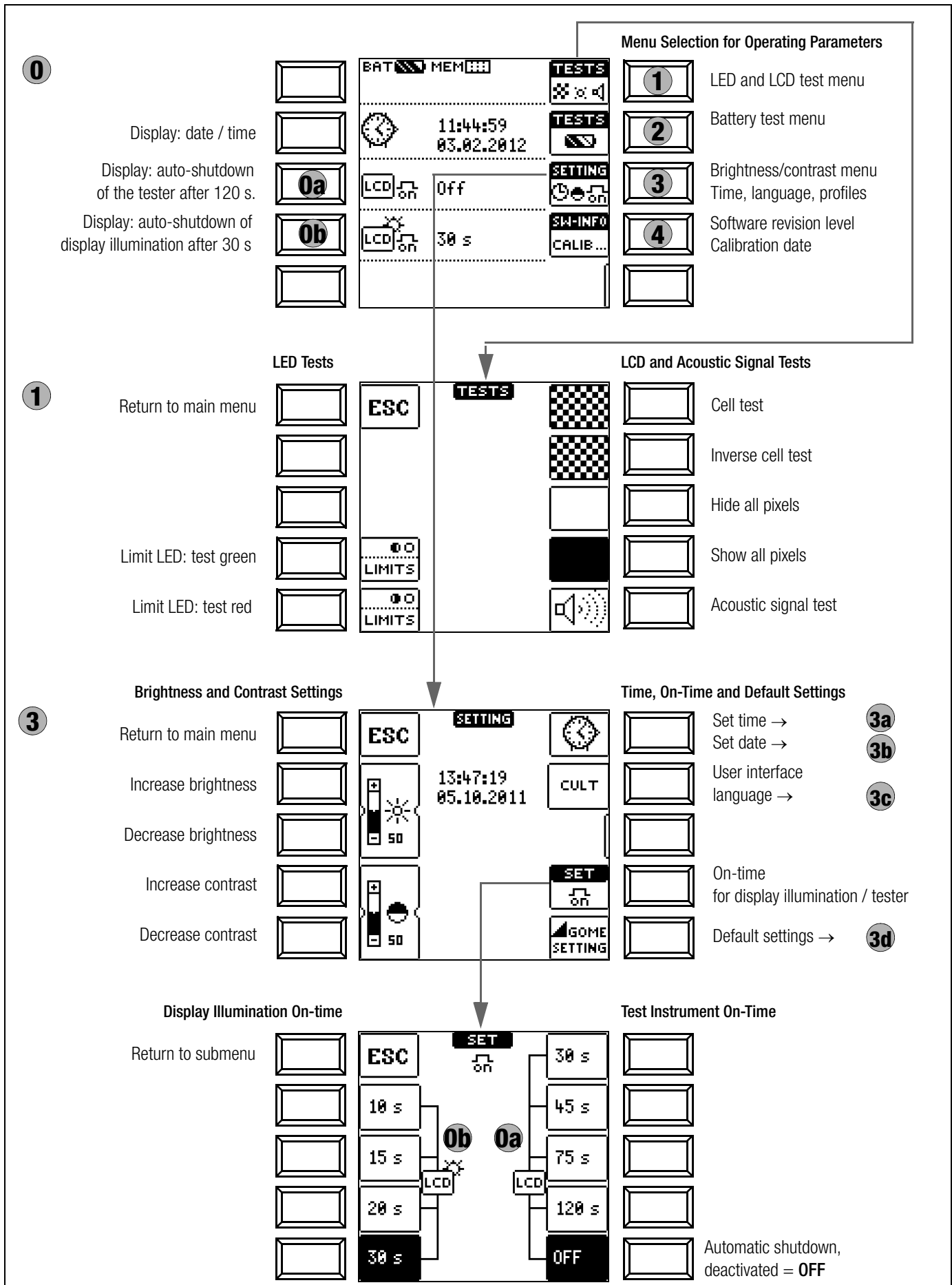
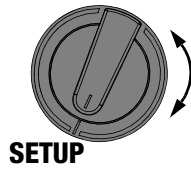

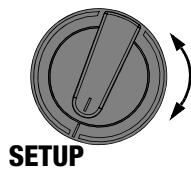

SETUP

<p>0</p> <p>Display: date / time</p> <p>Display: auto-shutdown of the tester after 45 s</p> <p>Display: auto-shutdown of display illumination after 15 s</p>			<p>1</p> <p>2</p> <p>3</p> <p>4</p>	<p>Menu Selection for Operating Parameters</p> <p>LED and LCD test menu</p> <p>Battery test menu</p> <p>Brightness/contrast menu Time, language, profiles</p> <p>Software revision level Calibration date</p>
	<p>0a</p> <p>0b</p>			
	<p>3</p> <p>Return to main menu</p> <p>Increase brightness</p> <p>Decrease brightness</p> <p>Increase contrast</p> <p>Decrease contrast</p>	<p>Adjusting Brightness and Contrast</p>	<p>Set Time, Language, Profiles, Acoustic Signal</p> <p>Set time → 3a</p> <p>Set date → 3b</p> <p>User interface language → 3c</p> <p>On-time for display illumination / tester</p> <p>Default settings → 3d</p>	
	<p>3a</p> <p>Return to submenu</p> <p>Decrease hours</p> <p>Decrease minutes</p> <p>Decrease seconds</p>	<p>Set time</p>	<p>Select time/date</p> <p>Activate settings</p> <p>Increase hours</p> <p>Increase minutes</p> <p>Increase seconds</p>	
	<p>3b</p> <p>Return to submenu</p> <p>Decrease day</p> <p>Decrease month</p> <p>Decrease year</p>	<p>Set date</p>	<p>Select time/date</p> <p>Activate settings</p> <p>Increase say</p> <p>Increase month</p> <p>Increase year</p>	

Significance of Individual Parameters

0a Test Instrument On-Time

The period of time after which the test instrument is automatically shut off can be selected here. This selection has a considerable influence on the service life and the charging status of the batteries.



Note

As long as the T/F sensor is connected to the RS 232 interface, automatic shutdown of the ESD test instrument is disabled.

0b On-Time for LCD Illumination

The period of time after which LCD illumination is automatically shut off can be selected here. This selection has a considerable influence on the service life and the charging status of the batteries.

Submenu: Battery Level Query

Battery voltage U_{BAT} (U_0) can be queried here without subjecting the battery to a load.

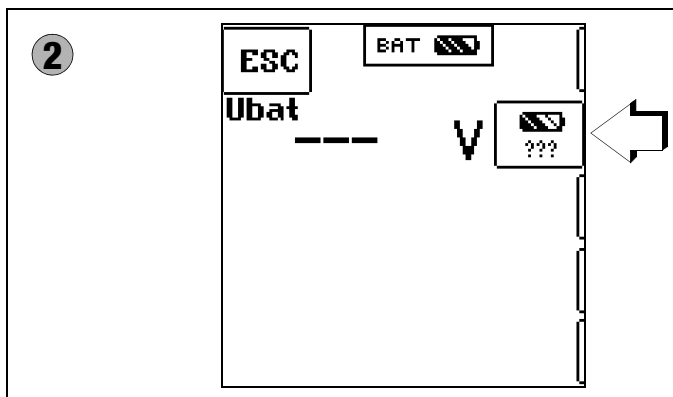

Note

Measuring Sequence

If battery voltage drops to below 8.0 V during the course of a measuring sequence, this is only indicated by means of a pop-up window. Measured values are invalid. Measurement results cannot be saved to memory.



⇨ Press **ESC** in order to return to the main menu.



Attention!

Data are lost when the language is changed, or if the instrument is reset to its default values!

Back up your measurement data to a PC with the help of ETC software before pressing the respective key. The prompt window shown at the right asks you to confirm deletion.



3c User Interface Language (CULTURE = LANGUAGE)

⇨ Select the desired language with the appropriate country code and acknowledge your selection by pressing the **✓** key.

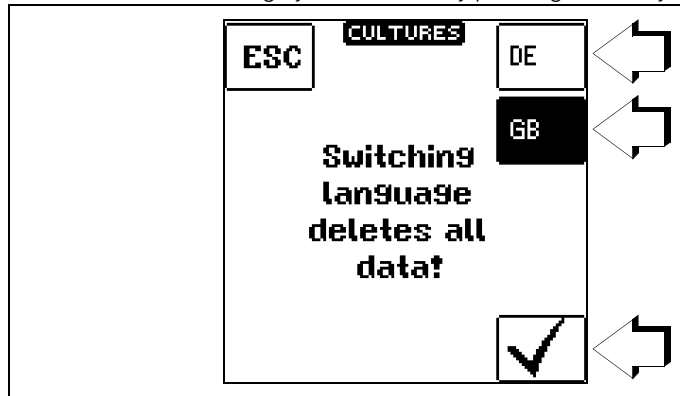

3d Default Settings (GOME SETTING)

The test instrument is returned to its original default settings when this key is activated.

Firmware Revision and Calibration Information (example)

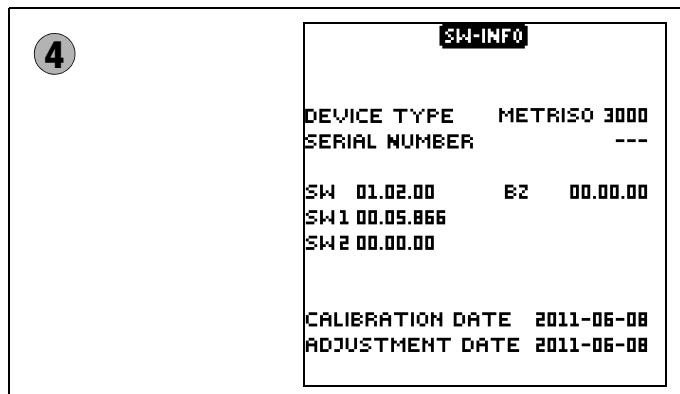

⇨ Press any key in order to return to the main menu.

4 General Operation

4.1 Connecting the Instrument

The test leads are connected to the “+” and “COM” jacks.

When resistance in the $G\Omega$ range is measured, the shielded cable (included) should be connected to the **COM** and **SHIELD** jacks. Be sure to observe color coding.

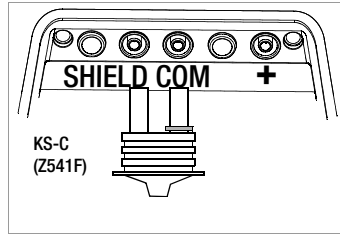

4.2 Switching On, Monitoring and Switching Off

If supply voltage drops to a value of less than 8.5 V, the LOW BATT pop-up message appears: No more measurements can be started.

If battery voltage falls below the allowable limit value of 8.0 V the instrument cannot be switched on, or it is switched off.

Nor can measurements be started in the resistance measuring ranges in the event of interference voltage.

The instrument only switches itself off automatically after completion of an (automatic) measuring sequence, and after the predetermined on-time has expired (see page 8). On-time is reset to its original value as defined in the setup menu, as soon as any key or the rotary function switch is activated.

If the instrument is switched off automatically with the rotary switch in any position other than **OFF**, it can be reactivated by pressing the **ESC** key. The instrument is also reactivated if the rotary switch is activated and turned through the **OFF** position.

The instrument can be switched off manually by turning the rotary switch to the **OFF** position.

4.3 Optical Indicators

LED	Status	Function – Cause
	Green	Limit Value Indication <ul style="list-style-type: none"> Measured resistance does not violate the limit value. Measured low-resistance does not violate the limit value.
	Red	Limit Value Indication <ul style="list-style-type: none"> Measured resistance is below the selected limit value. Measured low-resistance has exceeded the permissible limit value.
	Red	Interference voltage when switched off ¹ and indication of test voltage during the resistance measurement Dangerous voltage of greater than 50 V at the measurement inputs: <ul style="list-style-type: none"> Initialization of the resistance and low-resistance measurements is disabled. During the resistance measurement (R_{ESD}), high test voltage is applied to the measurement inputs.
		Detection of interference voltage in the on-state in the resistance measuring ranges after starting measurement

¹ Function testing should be executed at regular intervals (see following section regarding testing the LEDs).

Testing the LED which Indicates Detection of Interference Voltage when Switched Off – OFF Switch Position

- Apply a voltage of greater than 50 V (+ and COM jacks).
- Turn the rotary switch to the V position.
- Read the voltage value at the LCD.
- Turn the rotary switch to the OFF position.

Test results: If applied voltage is unchanged and the LED which indicates the detection of interference voltage lights up red, the LED is OK. In this case, the LED reliably indicates interference voltage even when the instrument is switched off. We recommend executing this test at regular intervals.

METRISO 3000 Measuring Functions, Measuring Ranges and Limit Values

	Measuring Ranges
R_{ESD}	$U_M = 10, 100, 500 V$
R	1 Ω ... 10 k Ω
U	0 ... 500 V
T	-10,0 ... +70,0° C
H_{REL}	10.0 ... 90.0%

Limit	Adjustable Limit Values	
	Lower Limit Value	Upper Limit Value
Limit R_{LO}	> 0.01 M Ω	< 0.01 M Ω
	> 0.1 M Ω	< 0.1 M Ω
	> 10 M Ω	< 5 M Ω
		< 35 M Ω
		< 100 M Ω
		< 1000 M Ω
		< 10000 M Ω
		< 100000 M Ω
		< 1000000 M Ω

4.4 Measurement Value Display and Memory

The following appear at the **display panel**:

- Measurement values with abbreviations and units of measure
- Selected function
- Error messages

Measurement values for automatic measuring sequences are stored and displayed as digital values until the next measurement sequence is started, or until automatic shutdown occurs.

If the upper range limit is exceeded, the upper limit value is displayed and is preceded by the “>” symbol (greater than), which indicates measurement value overrun.



Note

The depiction of LEDs in these operating instructions may vary from the LEDs on the actual instrument due to product improvements.

4.5 Setting Measuring Parameters per ESD Standards

1 Access the menu „ESD tests“.

2 Select the parameter (in this case Verification) with the \uparrow or \downarrow scroll key.

3 Switch to the settings menu for the selected parameter with the \rightarrow key.

4 Select a setting value using the \uparrow or \downarrow scroll key.

5 Acknowledge the setting value with the \downarrow key. This selection is transferred to the setting menu.

6 The selection is not permanently accepted for the respective measurement until \checkmark is pressed, after which the display is returned to the main menu. You can return to the main menu by pressing ESC instead of \checkmark , without accepting the newly selected value.

4.6 Setting Measuring Parameters using Limit Value Specifications as an Example (example: setting the “lower limit value”)

1 Access the submenu for setting the desired parameter.

2 Select the parameter (in this case the lower limit value) with the \uparrow or \downarrow scroll key.

3 Switch to the settings menu for the selected parameter with the \rightarrow key.

4 Select a setting value using the \uparrow or \downarrow scroll key.

5 Acknowledge the setting value with the \downarrow key. This value is transferred to the setting menu.

6 The setting value is not permanently accepted for the respective measurement until \checkmark is pressed, after which the display is returned to the main menu. You can return to the main menu by pressing ESC instead of \checkmark , without accepting the newly selected value.

- 1 Access the submenu for setting the desired parameter.
- 2 Select the parameter (in this case the lower limit value) with the \uparrow or \downarrow scroll key.
- 3 Switch to the settings menu for the selected parameter with the \rightarrow key.
- 4 Select a setting value using the \uparrow or \downarrow scroll key.
- 5 Acknowledge the setting value with the \downarrow key. This value is transferred to the setting menu.
- 6 The setting value is not permanently accepted for the respective measurement until \checkmark is pressed, after which the display is returned to the main menu. You can return to the main menu by pressing ESC instead of \checkmark , without accepting the newly selected value.

5 Measuring Direct and Alternating Voltage

You can measure direct voltage, as well as sinusoidal alternating voltage, with frequencies ranging from 45 to 65 Hz with this test instrument.

Select Measuring Function

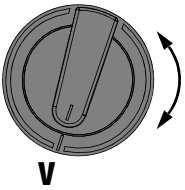

- ⇒ Select the **V** measuring function with the rotary switch.

Connection

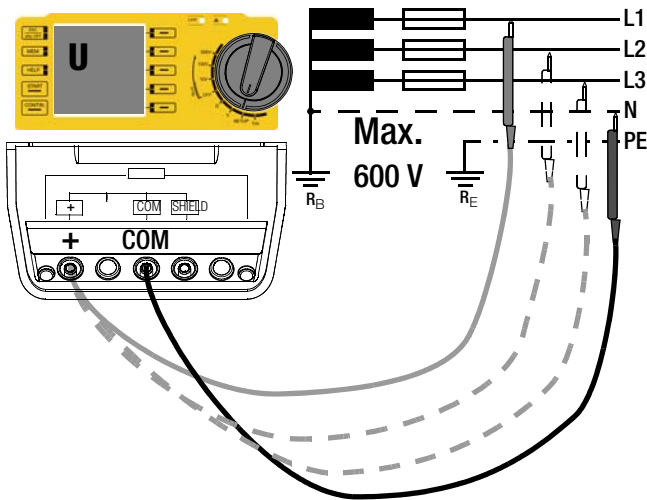

- ⇒ Connect the measurement cables to the **+** and **COM** jacks.
- ⇒ Contact the measuring point with both test probes.

Set Voltage Type Parameter (waveform)

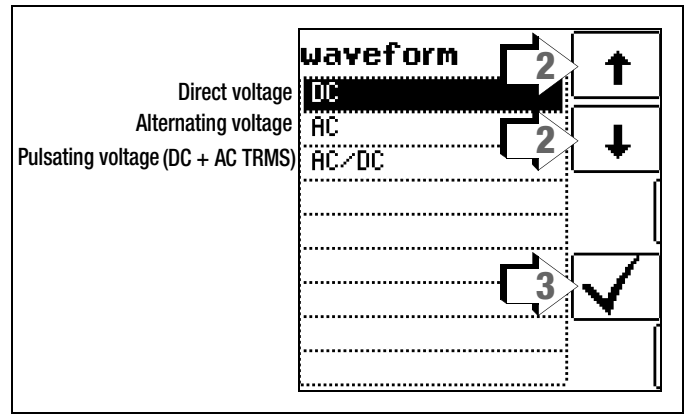
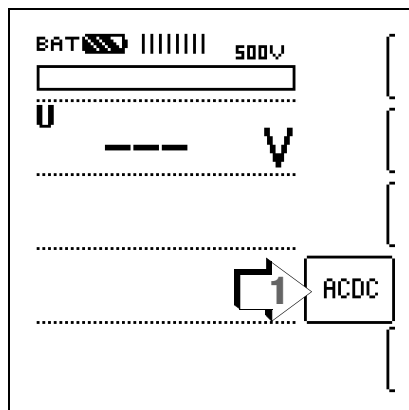

Measurement

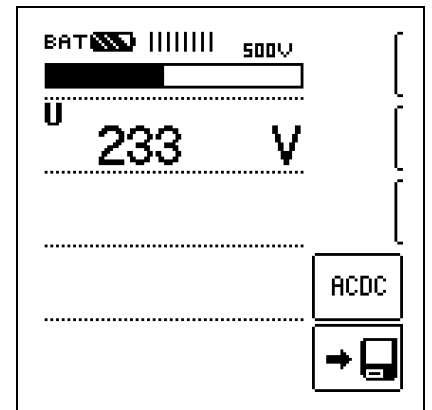

The measured value is displayed directly (without pressing the **START** key) – in analog format at the bar graph and in digital format at the matrix display.

- ⇒ After completing the measurement, switch the instrument off by turning the rotary switch to the **OFF** position.

The **ESC**, **START** and **CONTIN** keys have no function in this case.



Note

Input impedance for the voltage measuring range is 10 M Ω .

6 ESD Measurements

Select Measuring Function

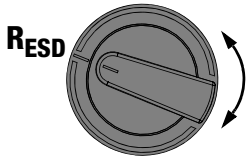

- Within the R_{ESD} measuring function, use the rotary switch to select desired measuring voltage U_M : 10 V, 100 V or 500 V.

Connection



Note

Checking Measurement Cables Before Measurements

Before performing resistance measurement, the test probes on the measurement cables should be short-circuited in order to assure that the instrument displays a value of less than 1 k Ω (see section entitled "Measuring Resistance – Ω Function"). In this way, incorrect connection can be avoided and broken measurement cables can be detected.

- Connect the device under test to the + and COM jacks.

Wiring examples for the ESD measurement are included in sections 7.1 through 7.5.

Resistance can only be measured at voltage-free objects. If mains voltage or interference voltage is applied to the measurement inputs, measurement cannot be started.

Set Parameters

All of the following parameters are used only for measurement documentation in the device's internal database, and do not influence the measurement itself. Database functions are explained in section 10.

Verification – Qualification Parameter

You can specify whether the measurement in question involves a verification or a qualification for documentation of your measurement in the device's internal database.

The respective selection is displayed in the key in the start menu.

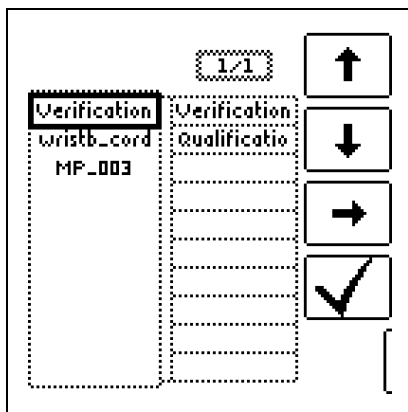

DUT Parameter

You can selected a suitable device under test from a list for documentation of your measurement.

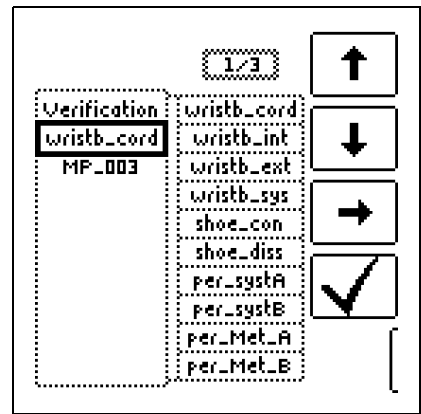

Measuring Point Parameter

You can specify a maximum number of different measuring points from 001 to 099 for documentation of your measurement.

The specified measuring points can be directly selected with the AUTO key (see "Fast Pole Switching" on next page).

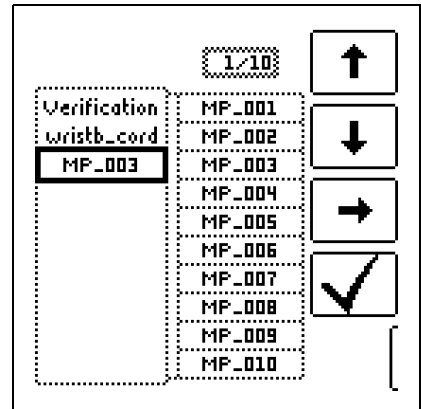

Limit Value > Limit Parameter

The lower limit value selected here appears to the left above Resd.

The red LED lights up if the limit value is fallen short of.

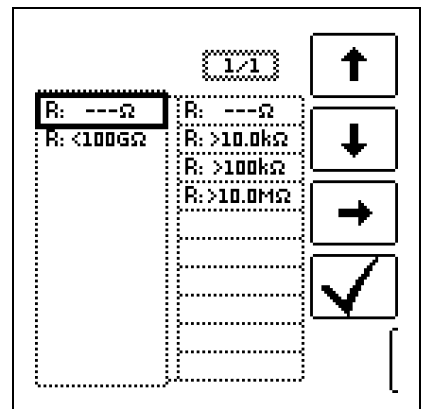

Limit Value < Limit Parameter

The upper limit value selected here appears to the right above Resd.

The red LED lights up if the limit value is exceeded.

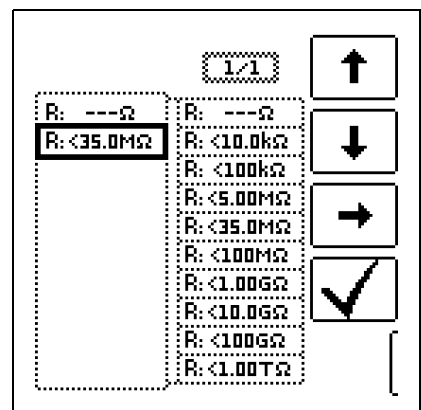

Semiautomatic Measurement Between Measuring Points

Fast, semiautomatic measurement is possible in all rotary switch positions for resistance measurement. However, measuring point selection is only relevant for documentation in the device's internal database.

Fast Pole Switching

Fast and convenient switching amongst all of the specified measuring points without opening the parameter settings submenu is possible after each measurement by pressing the save button on the instrument twice.

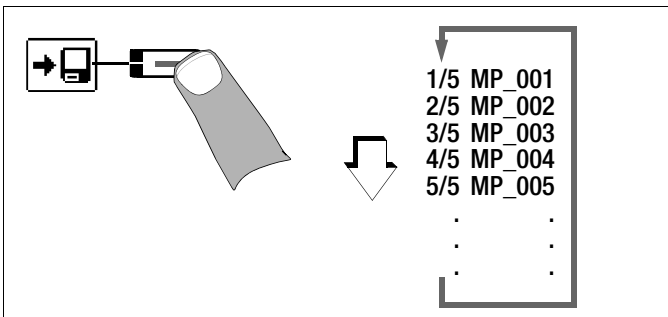
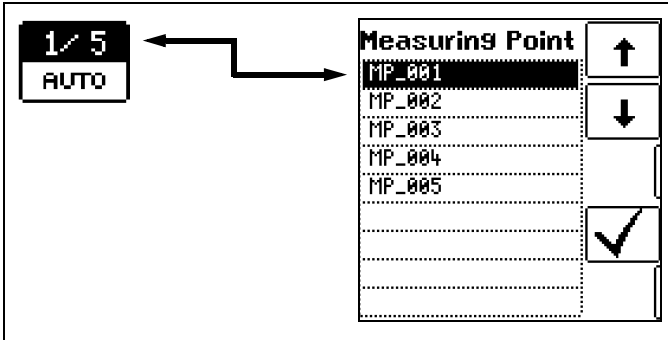

Start Measurement

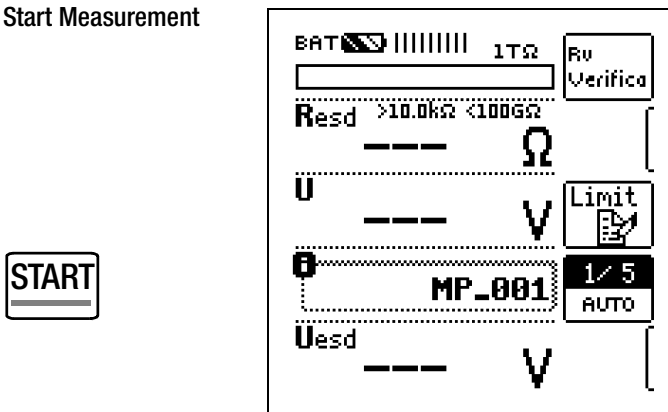

Continuous Measurement via the CONTIN Key



Note

The instrument's batteries are exposed to excessive stress during insulation resistance measurement. Stop continuous measurement with "constant test voltage" as soon as the display has settled in.

Measurement in progress

Resd = measured resistance

U = momentary voltage at the test probes

Uesd = nominal voltage or test voltage

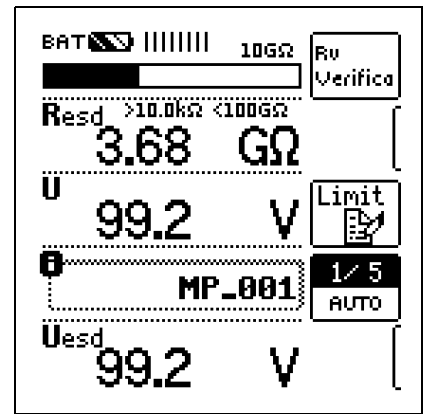

Measurement Results

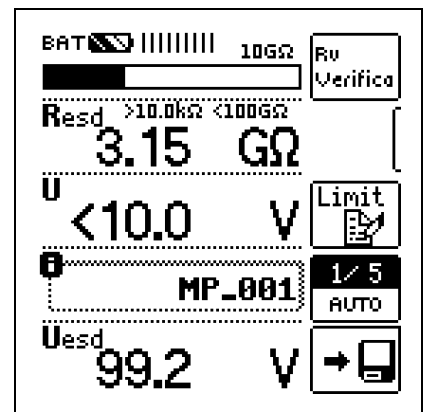

6.1 Discharging the Device Under Test



Attention!

If measurement is performed at a capacitive object such as a long cable, it becomes charged with up to approx. 600 V!

Touching such objects is life endangering!

When a resistance measurement has been performed on a capacitive object it is automatically discharged by the instrument after measurement has been completed. Contact with the device under test must be maintained to this end. The falling voltage value can be observed at the U display.

Do not disconnect the DUT until less than 10 V is displayed for U!

6.2 Measuring Resistance to ground R_g or R_{gp} according to IEC 61340-4-1

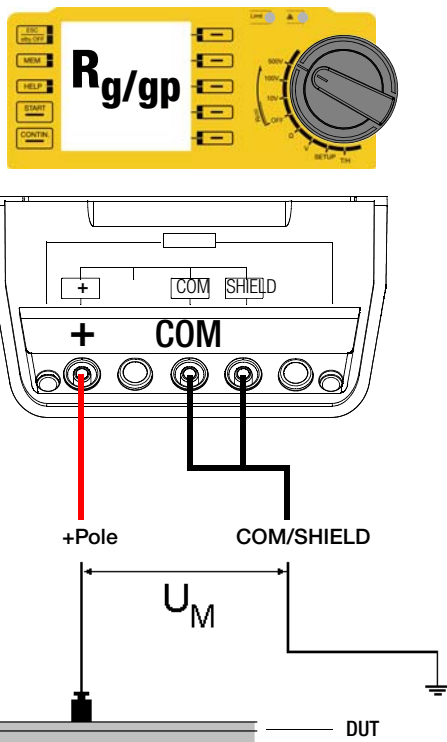

(e.g. for measuring flooring systems, table mats, chairs etc.)

- Connect the red measurement cable from the “+ Pole” to the measuring electrode.
- The black, shielded measurement cable with the double “COM / SHIELD” connectors is connected to protective earth when measuring R_g , or to a groundable point when measuring R_{gp} .

Note

Use only the 2-pole measurement cable.

- Select a measuring voltage of $U_M = 10\text{ V}$ in the Resd switch position. If a value of less than $1\text{ M}\Omega$ is displayed, this value is the result.
- If the resistance to ground $\text{Resd} \geq 1\text{ M}\Omega$ is displayed with the 10 V measuring voltage, the 100 V measuring voltage must be selected. The value which is then displayed is the result.

Measurement according to IEC 61340-4-1 Ed. 2.0:

Resd in Ω	Measuring Voltage (open-circuit voltage)
$\text{Resd} < 1 \times 10^5$	$10\text{ V} \pm 0.5\text{ V}$
$10^6 \leq \text{Resd} \leq 10^{11}$	$100\text{ V} \pm 5\text{ V}$

6.3 Measuring Resistance through a person to ground $R_{g\text{ System}}$ or $R_{gp\text{ System}}$

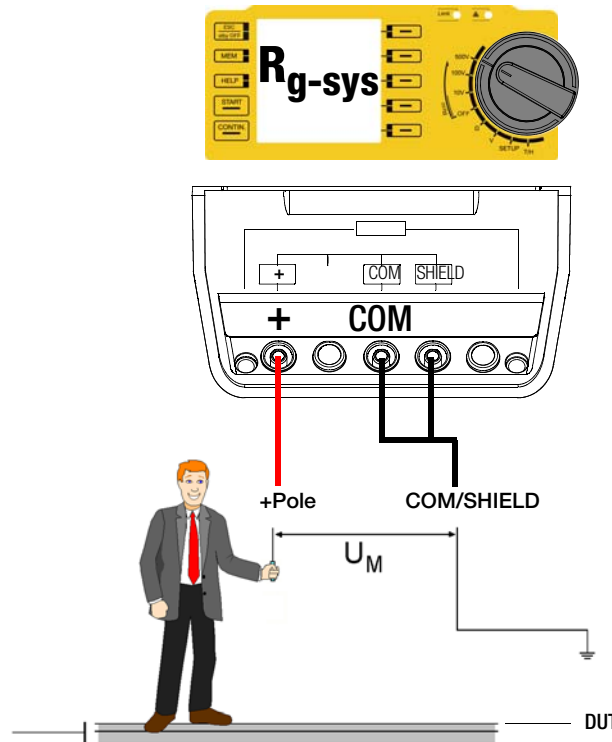

(e.g. for the measurement of a resistance through the combination of a person/shoes/flooring system according to IEC 61340-4-5)

- Connect the red measurement cable from the “+ Pole” to the measuring electrode.
- The black, shielded measurement cable with the double “COM / SHIELD” connectors is connected to protective earth when measuring $R_{g\text{ System}}$, or to a groundable point when measuring $R_{gp\text{ System}}$.

Note

Use only the 2-pole measurement cable.

- Select a measuring voltage of $U_M = 10\text{ V}$ in the Resd switch position. If a value of less than $1\text{ M}\Omega$ is displayed, this value is the result.
- If personal leakage resistance $\text{Resd} > 1\text{ M}\Omega$ is displayed with the 10 V measuring voltage, the 100 V measuring voltage should be selected. The value which is then displayed is the result.

Measurement according to IEC 61340-4-5

Resd in Ω	Measuring Voltage (open-circuit voltage)
$\text{Resd} < 1 \times 10^6$	$10\text{ V} \pm 0.5\text{ V}$
$\text{Resd} \geq 1 \times 10^6$	$100\text{ V} \pm 5\text{ V}$

6.4 Measuring Point-to-Point Resistance

6.4.1 Measuring Point-to-Point Resistance R_{p-p} with 2 Measuring Probes according to IEC 61340-2-3

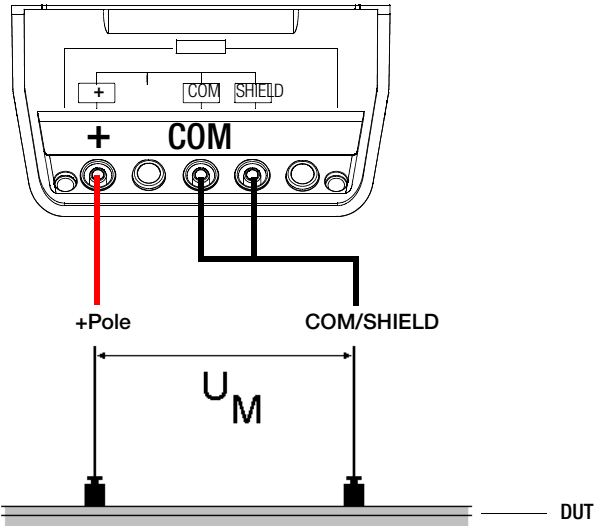
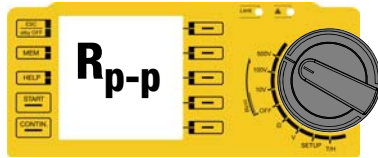

(e.g. for measuring the surfaces of workstations, trays, transport containers etc.)

- Connect the red measurement cable from the “+ Pole” to one measuring electrode and the black, shielded measurement cable with the double “COM / SHIELD” connectors to the other electrode.

Note

Use only the 2-pole measurement cable.

- Select a measuring voltage of $U_M = 10\text{ V}$ in the Resd switch position. If a value of less than $1\text{ M}\Omega$ is displayed, this value is the result.
- If surface resistance $\text{Resd} \geq 1\text{ M}\Omega$ is displayed with the 10 V measuring voltage, the 100 V measuring voltage must be selected. The value which is then displayed is the result

Measurement according to IEC 61340-2-3

Resd in Ω	Measuring Voltage (open-circuit voltage)
$\text{Resd} < 1 \times 10^6$	$10\text{ V} \pm 0.5\text{ V}$
$\text{Resd} \geq 1 \times 10^6$	$100\text{ V} \pm 5\text{ V}$

6.4.2 Measuring Surface Resistance R_S of Packaging Materials with a Ring Probe according to IEC 61340-2-3

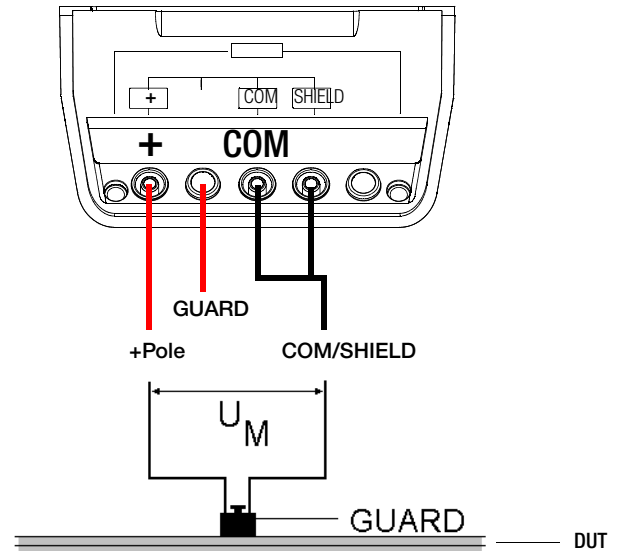

(e.g. for measuring dissipative packaging materials)

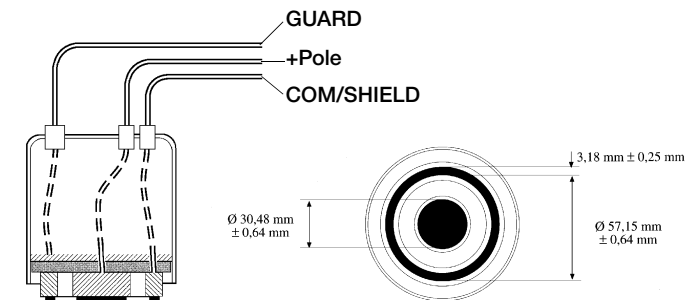

- Connect the red measurement cable from the “+ Pole” to one measurement jack and the black, shielded measurement cable with the double “COM / SHIELD” connectors to the other measurement jack.

Note

Use only the 2-pole measurement cable.

- Contact the “GUARD terminal” at the ring electrode with the GUARD socket at the **METRISO 3000**.
- Select a measuring voltage of $U_M = 10\text{ V}$ in the Resd switch position. If a value of less than $1\text{ M}\Omega$ is displayed, this value is the result.
- If surface resistance $\text{Resd} \geq 1\text{ M}\Omega$ is displayed with the 10 V measuring voltage, the 100 V measuring voltage must be selected. The value which is then displayed is the result

Measurement according to IEC 61340-2-3

Resd in Ω	Measuring Voltage (open-circuit voltage)
$\text{Resd} < 1 \times 10^6$	$10\text{ V} \pm 0.5\text{ V}$
$\text{Resd} \geq 1 \times 10^6$	$100\text{ V} \pm 5\text{ V}$

6.5 Measurement of Volume Resistance R_V according to IEC 61340-2-3

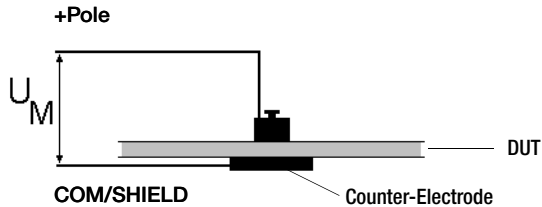

(e.g. for determining the volume resistance of a material)

- ⇨ Connect the red measurement cable from the “+ Pole” to the measuring electrode and the black, shielded measurement cable with the double “COM / SHIELD” connectors to the counter-electrode.
- ⇨ Select a measuring voltage of $U_M = 10 \text{ V}$ in the Resd switch position. If a value of less than $1 \text{ M}\Omega$ is displayed, this value is the result.
- ⇨ If volume resistance $\text{Resd} \geq 1 \text{ M}\Omega$ is displayed with the 10 V measuring voltage, the 100 V measuring voltage must be selected. The value which is then displayed is the result

Measurement according to IEC 61340-2-3

Resd in Ω	Measuring Voltage (open-circuit voltage)
$\text{Resd} < 1 \times 10^6$	$10 \text{ V} \pm 0.5 \text{ V}$
$\text{Resd} \geq 1 \times 10^6$	$100 \text{ V} \pm 5 \text{ V}$

6.6 Measurement with the GUARD Terminal

The measurement of very high resistances leads to extremely low measuring current and may be rendered problematic as a result of influences such as electromagnetic fields, humidity or surface current. An accurate test set-up is thus absolutely essential.

A guard cable must be used for measurements within a range of $10 \text{ G}\Omega$ to $1 \text{ T}\Omega$, in order to prevent surface current from distorting measurement results. The GUARD terminal at the measuring electrode prevents current on the surface of the high-impedance material to be measured from flowing from the + measurement cable to the – measurement cable instead of through the high-impedance material itself.

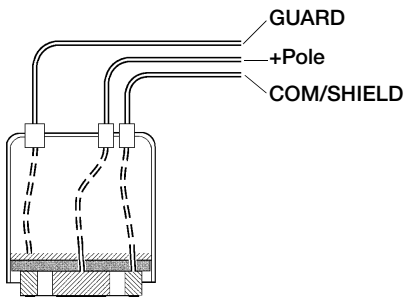

Ring Electrode according to IEC 61340-2-3

- ⇨ Connect the GUARD terminal at the measuring electrode to the GUARD socket at the METRISO 3000 when measuring very high-ohmic materials

The measuring sequence is the same as described in the previous sections.

7 Test Resistor for Resistance Measurement for Checking the High Resistance Tester

It's advisable to check the measuring instrument before, and if necessary after use.

The two outermost jacks on the connection panel must be connected to each other internally via a $10 \text{ M}\Omega$ test resistor to this end.

The sum of test resistor and cable resistance (for both cables), including test probes, amounts to $10 \text{ M}\Omega \pm 5\%$. This value allows for quick self-testing.

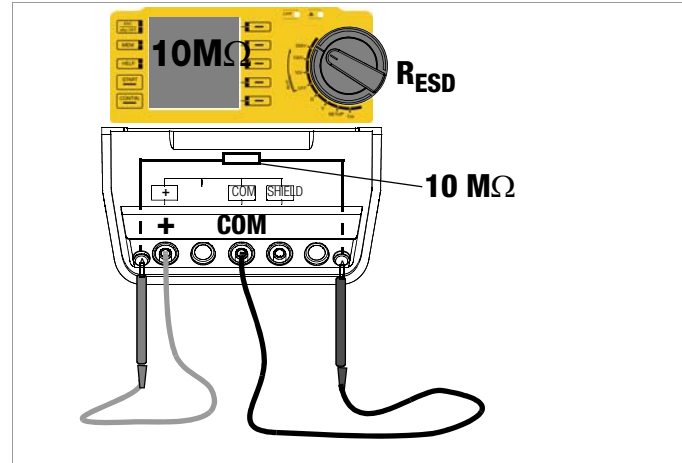

- ⇨ Connect the measurement cables to the + and COM jacks.
- ⇨ Insert the test probes into the above depicted jacks.
- ⇨ Within the R_{ESD} measuring function, use the rotary switch to select desired measuring voltage U_M : 10 V , 100 V or 500 V .
- ⇨ Press the start key and view the measurement results.

8 Measuring Resistance – Ohm Function

Resistances of greater than 1 Ω and less than 10 k Ω are measured in this switch position.

Select Measuring Function

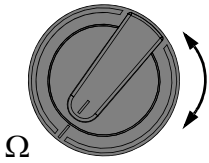

- Select the Ω measuring function with the rotary switch.

Connection

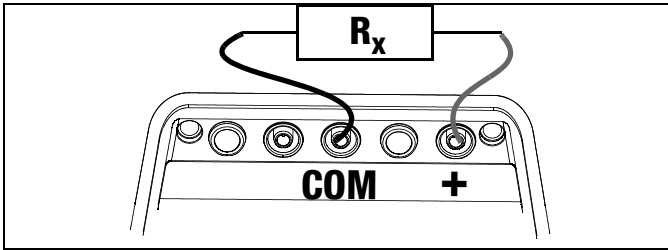

- Connect the device under test to the + and COM jacks.



Attention!

Resistance can only be measured at voltage-free objects. If mains voltage or interference voltage is applied to the measurement inputs, measurement cannot be started.

Start Measurement

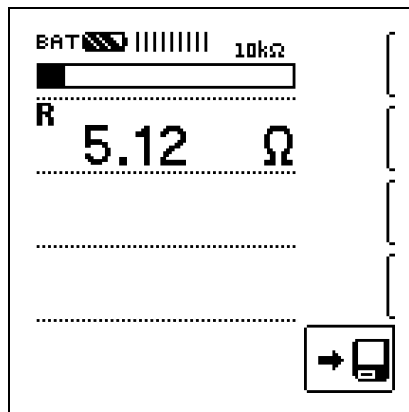

- Start an individual measurement by briefly pressing the **START** key, or initiate continuous measurement by briefly pressing the **CONTIN** key.

9 Temperature and Humidity Measurement with the Z550B T/F Adapter

Applications

Temperatures from -10.0° C to +70.0° C and humidity within a range of 10.0% and 90.0% can be measured with the combination temperature-humidity adapter.

Observe the operating instructions for the adapter.

Attachment to the Test Instrument

- Lift the protective rubber flap.
- Plug the temperature-humidity adapter into the RS 232 port at the test instrument.

Select Measuring Function

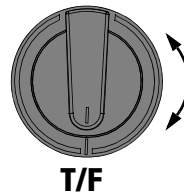

- Select the **T/F** measuring function with the rotary switch. The adapter is switched on via the RS 232 port.

If you have not yet plugged the temperature-humidity adapter into the test instrument's RS 232 port, or if the adapter is not making good contact with the port, the error message shown at the right appears.

Make sure that the adapter is correctly seated.

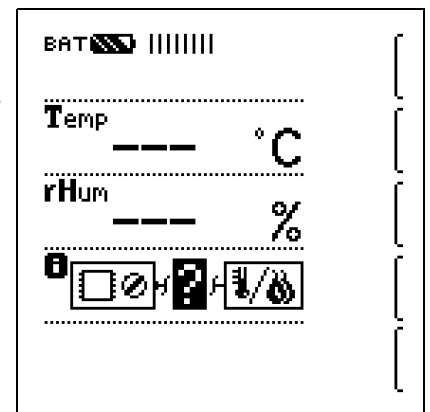

Start Measurement

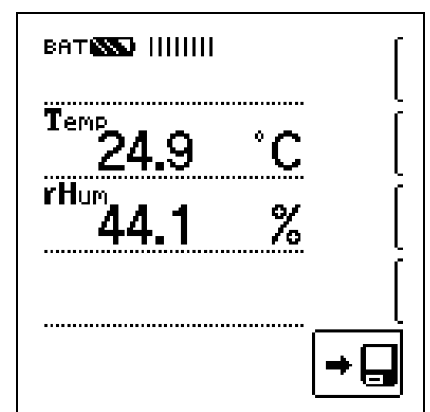

Note

As long as the T/F sensor is connected to the RS 232 interface, automatic shutdown of the ESD test instrument is disabled.

10 Database

10.1 Creating ESD Control Elements, General

A complete structure with customer, building and ESD control elements can be created in the **METRISO 3000** test instrument. This structure makes it possible to assign measurements to ESD control elements in various buildings and customer facilities.

There are two possible procedures:

Create a structure in the test instrument.

A structure with up to 50,000 ESD control elements can be created in the test instrument, which is saved to the instrument's flash memory.

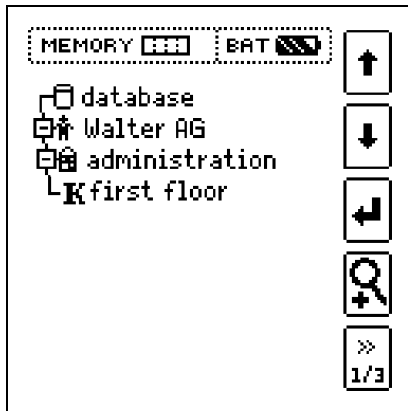

or

- Create and save an image of an existing structure at a PC with the help of **ETC report generating software** (Electric Testing Center) (see condensed operating instructions for ETC report generating software). The structure is then transferred to the test instrument.

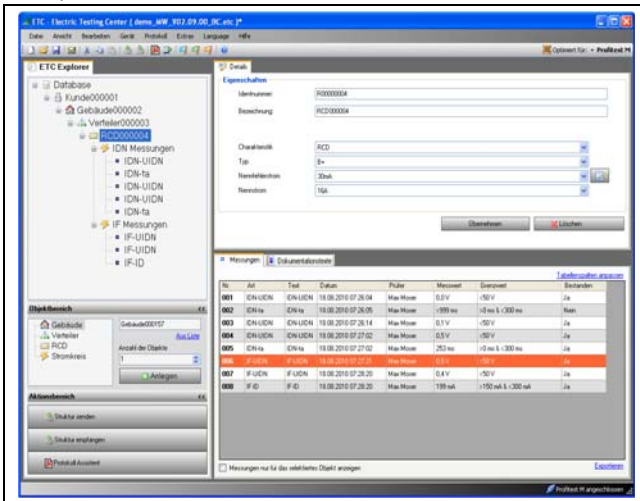

Note regarding ETC Report Generating Software

The following steps must be completed before using the software:

- Install USB device drivers (required for operation of the **METRISO 3000** at a PC)
- Install ETC report generating software: See information regarding ETC – Electric Testing Center. (3-349-472-15)

10.2 Transferring Structures

The following data transfer operations are possible:

- Transfer a structure from the PC to the test instrument.
- Transfer a structure including measured values from the test instrument to the PC.

The test instrument and the PC must be connected with a USB cable in order to transfer structures and data.

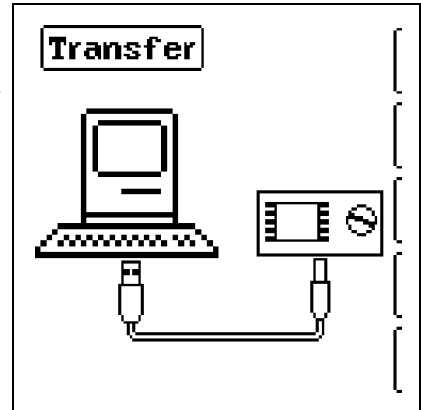

The following image appears at the display during transfer of structures and data.

10.3 Creating a Structure in the Test Instrument.

Overview of the Meanings of Icons used to Create Structures

Symbols		Meaning
Main Level	Sub-Level	
		Memory menu, page 1 of 3
		Cursor UP: scroll up
		Cursor DOWN: scroll down
		ENTER: acknowledge selection + → - change to sub-level (open directory) or - → + change to main level (close directory)
		Display structure designation or ID number
		Switch back and forth between structure designation and ID number
		Hide structure designation or ID number
		Change display to menu selection
		Memory menu, page 2 of 3
		Add a structural element
		Meaning of icons from top to bottom: Customer, building, ESD control element (display of the icons depends on the selected structural element). Selection: UP/DOWN scroll keys and ↵ In order to add a designation to the selected structural element, refer to the edit menu in following column.
	EDIT	For additional icons see edit menu below
		Delete the selected structural element.
		Show measurement data, if a measurement has been performed for this structural element.

Symbols	Meaning
	Edit the selected structural element.
Memory menu, page 3 of 3	
	Search for ID number. > Enter complete ID number.
	Search for text. > Enter full text (complete word).
	Search for ID number or text.
	Continue searching.
Edit menu	
	Cursor LEFT: Select an alphanumeric character.
	Cursor RIGHT: Select an alphanumeric character.
	ENTER: accept an individual character.
<input checked="" type="checkbox"/>	Acknowledge entry
←	Cursor left
→	Cursor right
	Delete characters.
	Switching amongst different types of alphanumeric characters:
A	✓ABCDEFGHIJK Upper case letters LMNOPQRSTUW XYZ↵↔
a	✓abcdefghijk Lower case letters lmnopqrstuvw xyz↵↔
0	✓0123456789+ Numbers -*/=:,;-()<> .!?↵↔
@	✓@#A00UUB€\$% Special characters &#ááééííóóúú ã ñæ↵↔

ESD Control Element Structure Symbology / Tree Structure

A **check mark** to the right of a structural element means that all measurements within the respective hierarchy have been passed.
Symbol x: At least one measurement has not been passed.
No symbol: Measurement has not yet been performed.

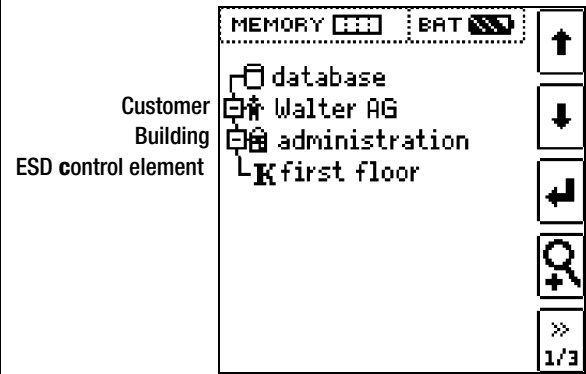

Same type of element as in the Windows Explorer:
+ : sub-objects available, display by pressing ↵.
- : sub-objects are displayed, hide by pressing ↵.

10.3.1 Creating Structures (example for floor covering, FLOOR 01)

After selection with the **MEM** key, all setting options for the creation of a tree structure are made available on three menu pages (1/3, 2/3 and 3/3). The tree structure consists of structural elements, referred to below as objects.

Select the position at which a new object will be added.

Use the ↑↓ keys in order to select structural elements.
Change to the sub-level with the ↵ key.
Go to the next page with the >> key

Create a new object.

Press the key in order to create a new object.

Select a new object from a list.

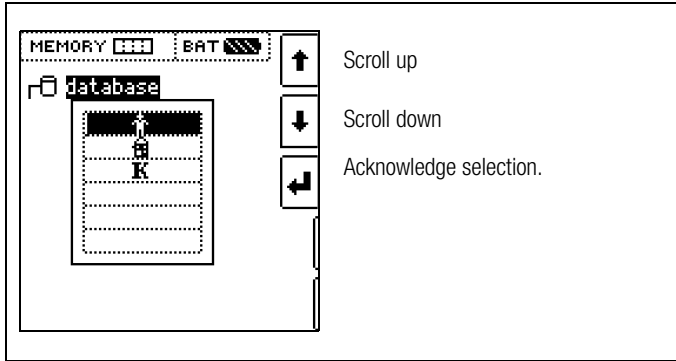

↑ Scroll up
 ↓ Scroll down
 ↵ Acknowledge selection.

Select the desired object from the list with the ↑↓ keys and acknowledge with the ↵ key.

Enter Designation – Example for Building

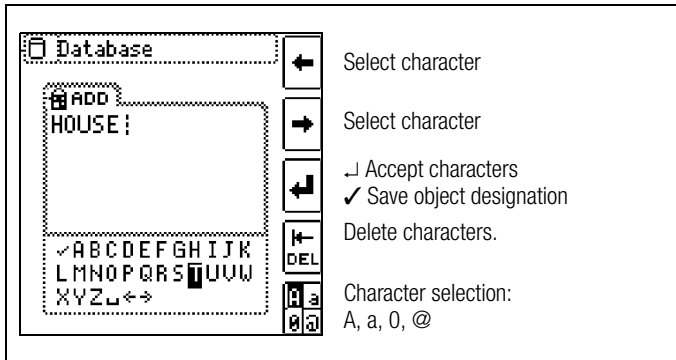

← Select character
 → Select character
 ↵ Accept characters
 ✓ Save object designation
 Delete characters.
 Character selection:
 A, a, 0, @

Enter a designation and then acknowledge it by entering a ✓.

Entering the Designation of an ESD Control Element

– Number of Measuring Points

Select object K from the list.

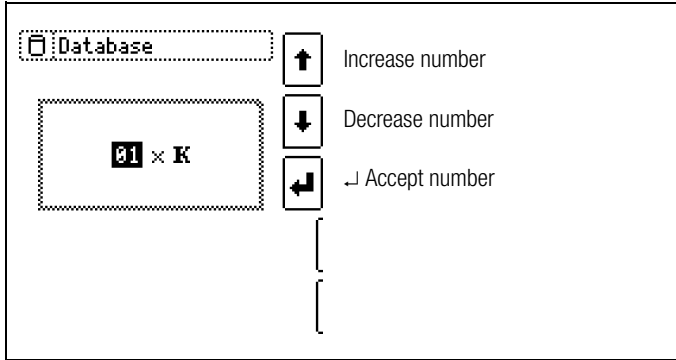

↑ Increase number
 ↓ Decrease number
 ↵ Accept number

A pop-up window appears at first, to which the number of measuring points for a new ESD control element have to be entered.

– Enter Designation

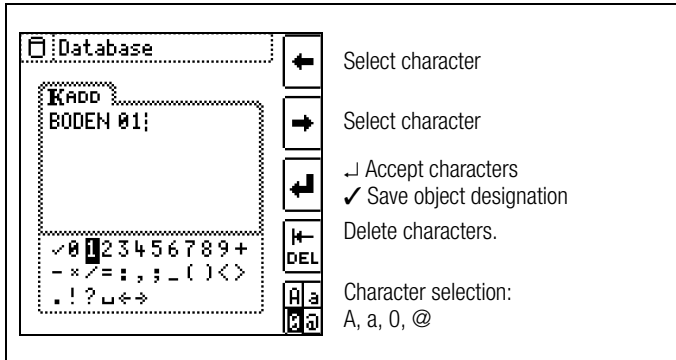

← Select character
 → Select character
 ↵ Accept characters
 ✓ Save object designation
 Delete characters.
 Character selection:
 A, a, 0, @

After acknowledging the number of measuring points by pressing ↵, another pop-up window appears to which a new designation has to be entered for the ESD control element. Acknowledge your entry by pressing ✓.

– Parameter Settings

The display now branches out to the parameter settings. The **verification** or **qualification** test method, as well as the type of control element, are selected here for the new ESD control element.



Note

✓ Acknowledge each preset or changed parameter with the symbol shown at the left which is found in the main parameters menu – the newly created designation is otherwise not accepted and the ESD control element is not created or saved.

Measuring parameters which have been accepted and saved in this way are subsequently accepted by the current measuring menu automatically when the display is switched from the structural view to measurement.

Control element parameters changed during structure creation are also retained for individual measurements (measurement without saving data).



Already existing ESD control elements can be subsequently edited by pressing the symbol shown at the left .

10.3.2 Searching for Structural Elements

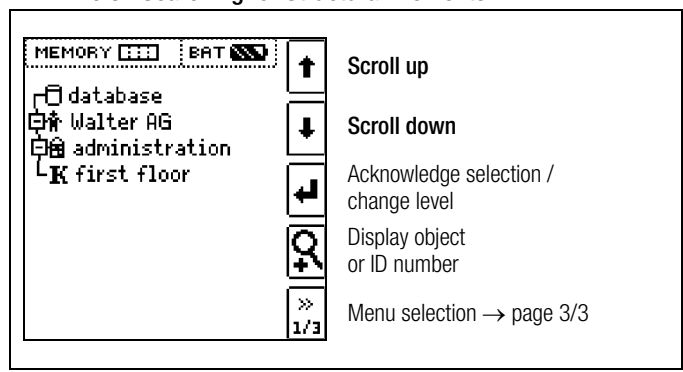

Mark the structural element from which the search will be started. Objects located underneath or next to this object will be included in the search.

Go to page 3/3 in the database menu.

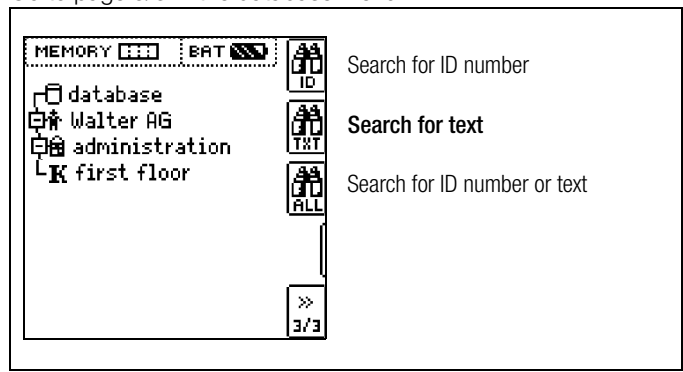

After selecting text search ...

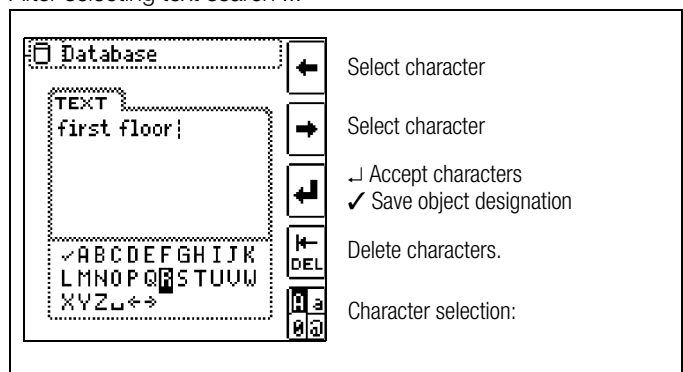

← Select character
 → Select character
 ↵ Accept characters
 ✓ Save object designation
 Delete characters.
 Character selection:
 A, a, 0, @

... and entering the desired text (only full matches are found – no wild cards, case sensitive)

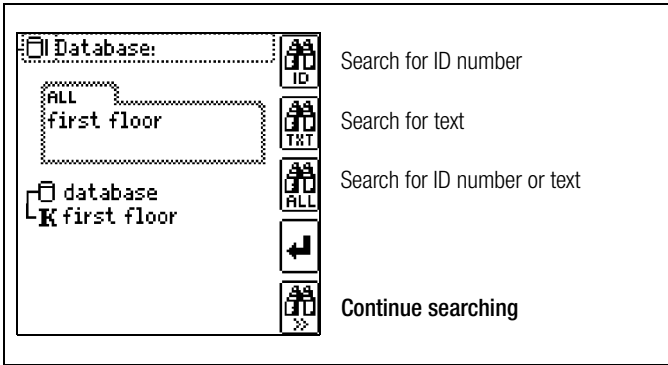

The first match is displayed.

Further matches can be found by selecting the icon shown at the right.

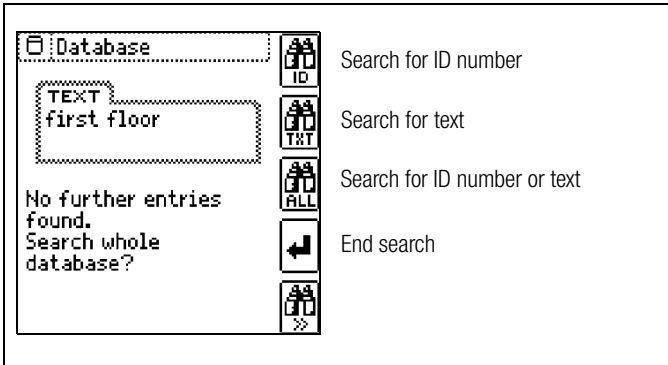

If no further matches are found, the message shown above is displayed.

10.4 Saving Data and Generating Reports

Preparing and Executing a Measurement

Measurements can be performed and stored to memory for each structural element. Proceed as follows, adhering to the prescribed sequence:

- Select the desired measurement with the rotary selector switch.
- Start the measurement by pressing the **START** key.

Upon completion of measurement, the “→ Floppy Disk” softkey is displayed.

- **Briefly** press the “Save Value” key.



The display is switched to the memory menu or the structural view.

- Navigate to the desired memory location, i.e. to the desired structural element / object, for which the measurement data will be saved.
- If you would like to save a comment along with the measurement, press the key shown at the right and enter a designation via the “EDIT” menu as described in section 10.3.1.
- Complete data storage by pressing the “STORE” key.



Alternative Storage Procedure

- The measured value can be saved to the last selected object in the structural diagram by **pressing and holding** the “Save Value” key, without switching the display to the memory menu.



Note

If you change the parameters in the measurement view, they are not saved for the structural element. A measurement with changed parameters can nevertheless be saved to the structural element, and any changed parameters are documented in the report for each measurement.

Retrieving Saved Measured Values

- Switch the display to the structure by pressing the **MEM** key and select the desired ESD control element with the scroll keys.
- Switch to page 2 by pressing the key shown here:
- Display the measurement data by pressing the key shown here:



One measurement with date and time, as well as any comment you might have entered, is displayed in each screen.

Example:

RES_D measurement

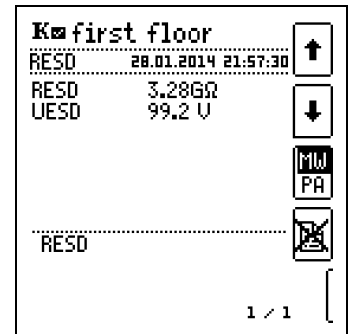

Note

An inverse displayed **check mark** in the header means that the respective measurement has been passed.

An inverse displayed **X** means that the measurement has not been passed.

- Scrolling amongst measurements is possible with the keys shown here:

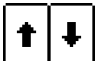

- The measurement can be deleted with the key shown here:



A prompt window asks you to confirm deletion.



With the help of the key shown at the right (MW: measured value / PA: parameter), the setting parameters can be displayed for this measurement.

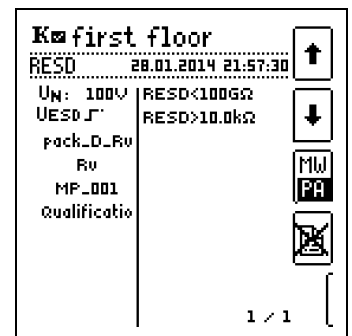

- Scrolling amongst measurements is possible with the keys shown here:



Data Evaluation and Report Generation with ETC Software

All data, including the structure of the ESD elements, can be transferred to the PC and evaluated with the help of ETC software. Additional information can be edited here subsequently for the individual measurements. After pressing the appropriate key, a report including all measurements within a given structure is generated, or the data are exported to an Excel spreadsheet.



Note

The database is exited when the rotary selector switch is turned. Previously selected parameters in the database are not used for the measurement.

10.4.1 Use of Barcode Scanners and RFID Readers

Search for an Already Scanned Barcode

The search can be started from any switch setting and menu.

⇒ Scan the object's barcode.

The search is started based on the currently selected structural element down through lower hierarchical levels. The found barcode is displayed inversely.

⇒ This value is accepted after pressing the ENTER key.



Note

An already selected object cannot be found.

Continued Searching in General



Regardless of whether or not an object has been found, searching can be continued by pressing this key:

- Object found: Searching is continued underneath the previously selected object.
- No further object found: The entire database is searched at all levels.

Reading In a Barcode for Editing

If the menu for alphanumeric entry is active, any value scanned by means of a barcode or RFID reader is accepted directly.

11 Characteristic Values

METRISO 3000

Meas. Qty.	U_M ²		Range	Measuring Range	Resolution	Intrinsic Error ¹	Measuring Uncertainty	Overload Capacity
R_{ESD}	10 V ³		10 k Ω	1.0 k Ω ... 9.99 k Ω	0.01 k	$\pm(5\% \text{ rdg.} + 10 \text{ d})$	$\pm(7\% \text{ rdg.} + 10 \text{ d})$	500 V AC/DC TRMS
			100 k Ω	10.0 k Ω ... 99.9 k Ω	0.1 k	$\pm(5\% \text{ rdg.} + 3 \text{ d})$ ⁵	$\pm(7\% \text{ rdg.} + 3 \text{ d})$	
			1 M Ω ⁴	100 k Ω ... 999 k Ω	1 k	$\pm(5\% \text{ rdg.} + 3 \text{ d})$	$\pm(7\% \text{ rdg.} + 3 \text{ d})$	
	100 V 500 V	3 3	10 M Ω	1.00 M Ω ... 9.99 M Ω	10 k	$\pm(5\% \text{ rdg.} + 3 \text{ d})$	$\pm(7\% \text{ rdg.} + 3 \text{ d})$	
			100 M Ω	10.0 M Ω ... 99.9 M Ω	100 k	$\pm(5\% \text{ rdg.} + 3 \text{ d})$	$\pm(7\% \text{ rdg.} + 3 \text{ d})$	
			1 G Ω	100 M Ω ... 999 M Ω	1 M	$\pm(5\% \text{ rdg.} + 3 \text{ d})$	$\pm(7\% \text{ rdg.} + 3 \text{ d})$	
			10 G Ω	1.00 G Ω ... 9.99 G Ω	10 M	$\pm(5\% \text{ rdg.} + 3 \text{ d})$	$\pm(10\% \text{ rdg.} + 3 \text{ d})$	
			100 G Ω	10.0 G Ω ... 99.9 G Ω	100 M	$\pm(8\% \text{ rdg.} + 3 \text{ d})$	$\pm(10\% \text{ rdg.} + 3 \text{ d})$	
			1 T Ω	100 G Ω ... 999 G Ω	1 G	$\pm(25\% \text{ rdg.} + 5 \text{ d})$	$\pm(50\% \text{ rdg.} + 20 \text{ d})$	
U AC/DC			100 V	10.0 V ... 99.9 V	0.1 V	$\pm(2.5\% \text{ rdg.} + 3 \text{ d})$	$\pm(5\% \text{ rdg.} + 3 \text{ d})$	500 V AC/DC TRMS
			500 V	100 V ... 499 V	1 V			
R	Display range as of 01.0 Ω		100 Ω	1.0 ... 99.9 Ω	0.1 Ω	$\pm(2.5\% \text{ rdg.} + 3 \text{ d})$	$\pm(5\% \text{ rdg.} + 3 \text{ d})$	500 V AC/DC TRMS
			1 k Ω	100 ... 999 Ω	1 Ω			
			10 k Ω	1.00 ... 9.99 k Ω	10 Ω			

¹ With the included, shielded, high-impedance measurement cables

² DC measuring voltage $U_M \pm 5\%$

³ See figure 1 on page 26

⁴ stable as from 200 k Ω U_M , see figure 1 on page 26

⁵ U_M 10 V: +7 Digit

Reference Conditions

Reference temperature	+ 23° C \pm 3 K
Relative humidity	40 ... 75 %
Measured quantity frequency	45 Hz ... 65 Hz
Measured quantity waveform	Sine, deviation between TRMS and rectified value < 1 %
Battery voltage	9.5 V \pm 0.1 V
Test resistance	10 M Ω \pm 1 %

Electrical Safety

Protection class	II per IEC/EN 61010-1/VDE 0411-1
Pollution degree	2
Measuring category	CAT II, 600 V
Fuses	
Fuse link	FF315mA/1000V, effective in all resistance measuring ranges, 1 additional replacement fuse in the battery compartment
Electronic fuse	For protecting resistance measurement R

Electromagnetic Compatibility (EMC)

Interference emission	EN 61326-1:2006, class B
Interference immunity	EN 61326-1:2006

Power Supply

Batteries	8 ea. 1.5 V mignon cell (8 ea. size AA) (alkaline manganese per IEC LR14) or 8 rechargeable NiMH batteries (must be recharged externally)
Z502R charger	Broad-range charger with barrel connector, input: 100 to 240 V AC, output: 16.5 V DC, 1 A (Mascot)
Nominal range of use	8.5 ... 12 V
Battery test	Battery capacity display with battery symbol in 4 segments:  . Querying of momentary battery voltage via menu function.

Battery saver circuit Automatic shutdown of display illumination after 10 to 30 seconds (after the last time the rotary switch is actuated) can be selected in the setup menus (see page 8). The test instrument is automatically switched to the **standby mode** if the measured value remains unchanged for approximately 15 minutes, and if none of the controls are activated during this time. The instrument is switched **off automatically** if the measured value remains unchanged for a long period of time, and if none of the keys or the rotary switch have been activated during on-time (specified in seconds).

Service life 3000 measurements with a set of rechargeable batteries and a measuring time of 5 seconds from one measurement until automatic shutdown of the measuring procedure.

Safety shutdown If supply voltage is too low ($U < 8 \text{ V}$), the instrument is switched off, or cannot be switched on.

Recharging socket Installed rechargeable batteries can be recharged directly by connecting a charger to the recharging socket:
MPRO MXTRA G1000+ charger (Z502R)

Charging time Approx. 2 hours *

* Maximum charging time with fully depleted rechargeable batteries. A timer in the charger limits charging time to no more than 4 hours.

Displays

Digital Display	Multiple display with dot matrix, 128 x 128 pixels, backlit (transflective), dimensions: 65 x 65 mm
Limit LED	LED lights up red to indicate an exceeded limit value LED lights up green to indicate adherence to the limit value
LED 	LED lights up red to indicate the presence of interference voltage (when instrument is switched off) or high test voltage at the measuring sockets during resistance measurement (R_{ESD})

Ambient Conditions

Accuracy temperature range	0 ... +40 °C
Operating temperature	-10 ... +50 °C
Storage temperature range	-25 ... +70 °C (without batteries)
Relative humidity	Up to 75% (max. 85% during storage/transport), no condensation allowed
Elevation	Max. 2000 m
Calibration interval	2 years (recommended)

Mechanical Design

Dimensions	225 x 130 x 140 mm
Weight	Approx. 1.4 kg with batteries
Protection	Housing: IP 52, measurement cables and connectors: IP 40 per DIN VDE 0470, part 1 / EN 60529, housing category 2

Excerpt from Table on the Meaning of IP Codes

IP XY (1 st digit X)	Protection Against Foreign Object Entry	IP XY (2 nd digit Y)	Protection Against Penetration by Water
2	≥ 12.5 mm dia.	2	Dripping (at 15° angle)
3	≥ 2.5 mm dia.	3	Spraying water
4	≥ 1.0 mm dia.	4	Splashing water
5	Dust protected	5	Jet-water
6	Dust-proof	6	Powerful water jets

Display Values in Consideration of Measuring Uncertainty

Table for determining minimum display values for insulation resistance in consideration of the instrument's measuring uncertainty.

Limit Value	Minimum Display Value
020 kΩ	025 kΩ
100 kΩ	111 kΩ
200 kΩ	219 kΩ
500 kΩ	541 kΩ
0.20 MΩ	0.25 MΩ
0.50 MΩ	0.57 MΩ
1.00 MΩ	1.11 MΩ
2.00 MΩ	2.19 MΩ
5.00 MΩ	5.41 MΩ
10.0 MΩ	11.1 MΩ
20.0 MΩ	21.9 MΩ
50.0 MΩ	54.1 MΩ
100 MΩ	111 MΩ
200 MΩ	219 MΩ
500 MΩ	541 MΩ
1.00 GΩ	1.11 GΩ
2.00 GΩ	2.19 GΩ
5.00 GΩ	5.41 GΩ
10.0 GΩ	11.1 GΩ
20.0 GΩ	22.6 GΩ
50.0 GΩ	55.9 GΩ

Table for determining maximum display values for low-value resistance in consideration of the instrument's measuring uncertainty.

Limit Value	Maximum Display Value
0.15 Ω	0.11 Ω
0.20 Ω	0.16 Ω
0.50 Ω	0.44 Ω
1.00 Ω	0.92 Ω
2.00 Ω	1.87 Ω
5.00 Ω	4.72 Ω
10.0 Ω	9.47 Ω
20.0 Ω	17.7 Ω
50.0 Ω	44.7 Ω

Voltage at Device Under Test During Insulation Resistance Measurement

Measuring voltage U_x at the device under test depending upon its resistance R_x at nominal voltages of 10, 100 and 500 V:

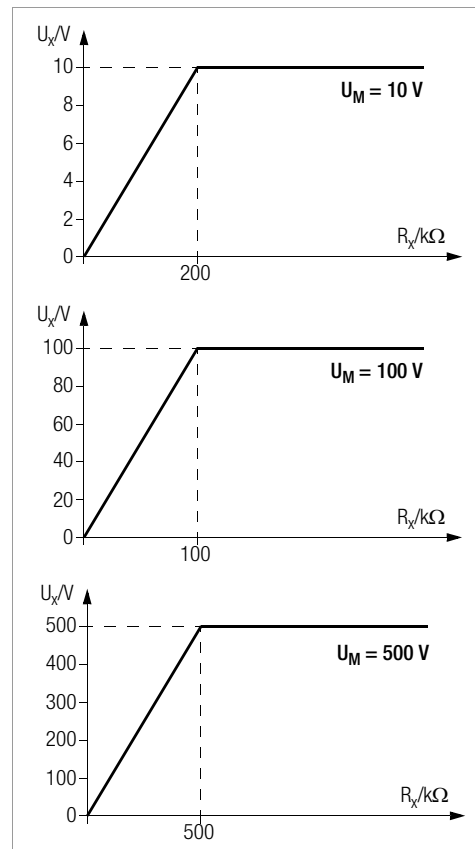

Figure 1: Characteristic Curves, $U_x(R_x)$

12 Maintenance

12.1 Firmware Revision and Calibration Information

See section 3.4.

12.2 Rechargeable Battery Operation and Charging

Check to make sure that no leakage has occurred at the rechargeable batteries in the Z502H batter pack at short, regular intervals, or after the instrument has been in storage for a lengthy period of time.



Note

Prior to lengthy periods of rest (e. g. holiday), we recommend removing the (rechargeable) batteries. This helps to prevent excessive depletion or leakage of batteries, which, under unfavourable circumstances, may cause damage to the instrument.

If battery voltage has fallen below the allowable lower limit, the pictograph shown at the right appears. "Low Batt!!!" is also displayed along with a battery icon. The instrument does not function if the batteries have been depleted excessively, and no display appears.



Attention!

Use only the Z502H battery pack.



Attention!

Use only the Z502R charger (available as an accessory) to charge batteries which have already been inserted into the test instrument.

Make sure that the following conditions have been fulfilled before connecting the charger to the charging socket:

- Rechargeable batteries have been installed with correct polarity (not standard batteries)
- The test instrument has been disconnected from the measuring circuit at all poles
- The instrument must remain off during charging.

If the batteries or the battery pack have not been used or recharged for a lengthy period of time, thus resulting in excessive depletion:

Observe the charging sequence (indicated by the LED at the charger) and initiate a second charging sequence if necessary (disconnect the charger from the mains and from the test instrument to this end, and then reconnect it).

12.2.1 Charging Procedure with the Z502R Charger (accessory: 7100.3000.Z502R)

- ⇨ Insert the correct mains plug for your country into the charger.



Attention!

Make sure that rechargeable batteries have been inserted (not normal batteries). We recommend the use of rechargeable NiMH batteries.

- ⇨ Connect the charger to the test instrument with the barrel connector, and then to the 230 V mains with the interchangeable plug.



Attention!

Do not switch the test instrument on during charging. Monitoring of the charging process by the microprocessor might otherwise be disturbed, in which case the charging times specified in the technical data can no longer be assured.

- ⇨ Please refer to the operating instructions included with the charger regarding the meanings of LED displays during the charging process.
- ⇨ Do not disconnect the charger from the test instrument until the LED lights up green.

12.3 Fuses

If a fuse has blown due to overloading, a corresponding message error appears at the display panel. The instrument's voltage measuring ranges are nevertheless still functional.

12.3.1 Fuse

This fuse is active in all resistance measuring ranges except for voltage measurement. A replacement fuse is included in the battery compartment (FF315mA/1000V).

Checking the Fuse

If a resistance measuring range is selected with the rotary switch with a blown or defective fuse in the instrument, and if measurement is started with the **START** or **CONTIN** key, a pop-up window with the "blown fuse" icon appears. Prerequisite: The + and **COM** measurement jacks are not short circuited.

This error message must be acknowledged and cleared by pressing the **ESC** key.

- ⇨ Eliminate the cause of failure and replace the blown fuse.



Replacing the Fuse



Attention!

Disconnect the instrument from the measuring circuit before opening the battery compartment lid in order to replace the fuse (refer to page 3 for location)!

The rotary switch must be in the OFF position when the fuse is replaced.



Attention!

Incorrect fuses may cause severe damage to the instrument.

Only original fuses from GMC-I Messtechnik GmbH assure the required protection by means of suitable blowing characteristics.

Short-circuiting of fuse terminals or the repair of fuses is prohibited!

The instrument may be damaged if fuses with incorrect ampere ratings, breaking capacities or blowing characteristics are used!

- ⇨ Open the battery compartment lid by loosening the two screws.
- ⇨ Remove the defective fuse and insert a new one. A replacement fuse is included in the battery compartment.
- ⇨ Insert the new fuse.
- ⇨ Replace the battery compartment lid and retighten the screws.

12.3.2 Electronic Fuse

This fuse protects resistance measurements ($k\Omega$) from overloading (electronic hardware circuit).

A pop-up window appears when the fuse blows.

This error message must be acknowledged and cleared by pressing any key.

- ⇨ Eliminate the cause of overloading.



12.4 Housing

No special maintenance is required for the housing. Keep outside surfaces clean. Use a slightly dampened cloth for cleaning. In particular for the protective rubber surfaces, we recommend a moist, lint-free microfiber cloth. Avoid the use of cleansers, abrasives or solvents.

12.5 Return and Environmentally Sound Disposal

The instrument is a category 9 product (monitoring and control instrument) in accordance with ElektroG (German electrical and electronic device law). This device is not subject to the RoHS directive.

In accordance with WEEE 2002/96/EG and ElektroG, we identify our electrical and electronic devices (as of Aug. 2005) with the symbol in accordance with DIN EN 50419 which is shown at the right. Devices identified with this symbol may not be disposed of with the trash. Please contact our service department regarding the return of old devices.



If the **batteries** used in your instrument or accessory product are depleted, they must be disposed of properly in accordance with valid national regulations.

Batteries may contain pollutants and heavy metals such as lead (Pb), cadmium (Cd) and mercury (Hg).

The symbol at the right indicates that batteries must not be disposed of with the trash, and must be brought to a designated collection point.













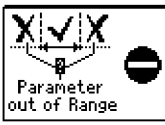

Pb Cd Hg

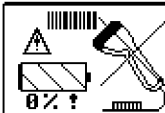
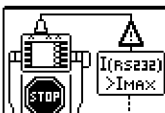
13 Appendix

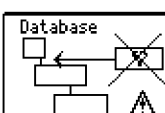
13.1 Error Messages

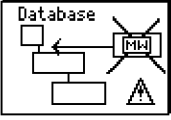
The following pop-up windows must be acknowledged or cleared by pressing any key, and the error must be eliminated.

Pop-Up	Position of the Function Switch	Function / Meaning
	All except for U	Interference voltage Remedy: device under test must be disconnected from all sources of voltage
	R _{ESD}	R _{OFFSET} > 5 Ω: OFFSET measurement is not sensible. Remedy: Check system.
	R _{ESD} / Ω	Externally accessible fuse is blown. The voltage ranges remain functional even if the fuse has blown. Special case for Ω: Interference voltage during measurement may result in a blown fuse. Remedy: Replace fuse (replacement fuse in battery compartment). Observe notes regarding fuse replacement in section 12.3.1!
	Ω	The electronic fuse protects resistance measurements (kΩ) from overloading (electronic hardware circuit). The voltage ranges remain functional even if the fuse has blown.
	All	Battery voltage is less than or equal to 8 V. Reliable measurement is no longer possible. Storage of measured values to memory is disabled. Remedy: Rechargeable batteries must be recharged, or replaced towards the end of their service life.
Database and Entry Operations		
	All	The parameters you have selected do not make sense in combination with previously configured parameters. The selected parameter settings will not be saved. Remedy: Enter other parameter settings.
	All	Please enter a designation (alphanumeric).
	All	Operation with a Barcode Scanner Error message appears when the "EDIT" entry field is opened and battery voltage is less than 8 V. Output voltage is generally switched off during barcode scanner operation if U is less than 8 V in order to assure that remaining battery capacity is adequate for entering designations for devices under test and saving the measurement. Remedy: Rechargeable batteries must be recharged, or replaced towards the end of their service life.
	All	Operation with a Barcode Scanner Current flowing through the RS 232 port is too high. Remedy: The connected device is not suitable for this port.
	All	Operation with a Barcode Scanner Barcode not recognized, incorrect syntax
	All	Data cannot be entered at this location within the structure. Remedy: Observe profile for preselected PC software (see SETUP menu).

Pop-Up	Position of the Function Switch	Function / Meaning
	All	Measured value cannot be saved at this location within the structure. Remedy: Make sure that you have selected the right profile for you PC evaluation program in the SETUP menu (see section 3.4).
	All	Memory is full. Remedy: Save your measurement data to a PC and then clear memory at the test instrument by deleting the database or by importing an empty database.
	All	Delete measurement or database. This prompt window asks you to confirm deletion.
	SETUP	Data loss after changing language or profile, or after restoring default settings. Back up your measurement data to a PC before pressing the respective key. This prompt window asks you to confirm deletion.

13.2 Optional Accessories (not included)

Master Battery Pack (material no. 7100.3000.Z502H)

8 LSD NiMH rechargeable batteries with reduced self-discharging (AA), 2000 mAh, with sealed cells

Charger (material no. 7100.3000.Z502R)

Broad-range charger for charging batteries in the measuring instrument
Input: 100 to 240 V AC, output: 16.5 V DC, 0.6 A

Edited in Germany • Subject to change without notice • PDF version available on the Internet

Wolfgang Warmbier GmbH & Co. KG
Systeme gegen Elektrostatik
Untere Gießwiesen 21
78247 Hilzingen, Germany

Phone: +49-77-3186-880
Fax: +49-77-3186-8830
e-mail info@warmbier.com
www.warmbier.com

