

Miniature Stainless Steel Vertical Float Switches Series: FS-410

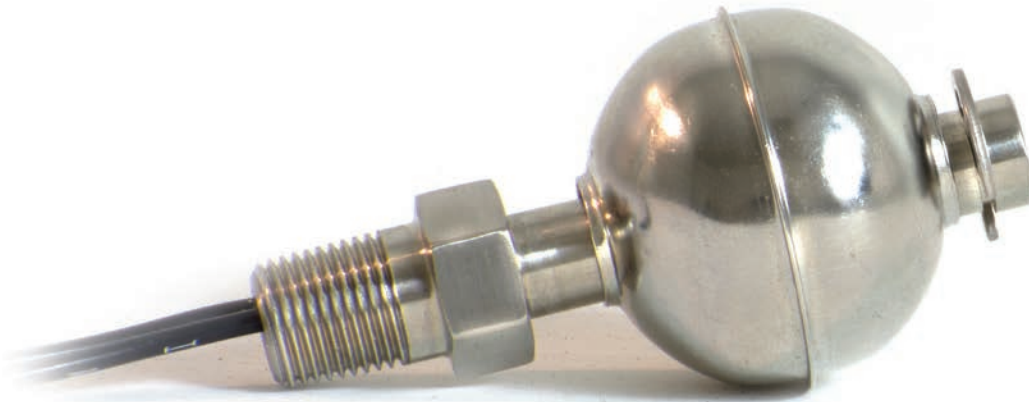

Series FS-410 Miniature Stainless Steel Vertical Float Switches are proof that excellence comes in small packages. Their compact size -- less than 2.35" from top of threads to end of stem -- all stainless steel wetted materials, and user-reversible switch orientation, make them any easy choice for OEM, water and wastewater, and chemical applications. All Series FS-410s carry NSF certifications, and Series FS-410-S switches are CSA Explosion Proof.

Features

- Extremely compact size
- Reliability/long switch life
- Shock resistive construction
- Can be used in a wide range of liquids
- Operating temperatures up to 500° F (260° C)
- Switch rated for 100W
- NSF 169 certified
- CSA Explosion Proof (Standard Temp) and General Use (High Temp)



FS-410 Specifications

Series

FS-410

Model

FS-410-S

FS-410-HT

Switch action for the FS-410 is reversible.
Standard is NO, user reversible for NC.

Performance

Pressure Rating	300 psi (20.7 bar)	
Minimum S.G.	0.7	
N.O. Actuation	0.130" ± 0.015" (3.30 mm ± .38 mm)	
N.C. Actuation	0.115" ± 0.015" (2.92 mm ± .38 mm)	
Hysteresis	0.060" ± 0.010" (1.52 mm ± .25 mm)	

Environmental

Operating Temp.	-40° to 368°F (-40° to 187°C)	-40° to 500°F (-40° to 260°C)
Liquids	Chemicals, Food, Potable Water	

Electrical

Switch Rating		
Max Capacity	100 W (resistive load only)	
Max Current (AC, 50/60 Hz)	240 VAC: 0.416 A; 120 VAC: 0.833 A; ≤100 VAC: 1 A	
Max Current (DC)	120 VDC: 0.833 A; ≤100 VDC: 1 A	
Life Expectancy	10 ⁶ - 10 ⁸ (# of actuations; dependent on load)	
Lead Wires	#22 AWG, Teflon 24 - 99 in. (610 - 2515 mm)	

Physical

Material		
Stem	316L SS	
Float	316L SS	
Retainer	316L SS	
Mounting	Vertical	

Certification

CSA/cCSAus Contract #237484	Explosion Proof	General Use
	Class I, Div 1 & 2, Groups A, B,C, & D, T3	--
	Class II, Div. 1, Groups E, F, T200°C	--
	Class II, Div. 2, Groups F, G, T200°C	--
	Class III	--
	Ta -40° C to 187° C	--
	Single Seal	
NSF 169	Yes	
Enclosure Rating	NEMA 4X	

Common Model Configurations

Model Number	Model Description
FS-410-S-M1-M1-0.7-P14-24	Stainless Steel Stem and Float, Standard Temperature , 0.7 SG, 1/8" NPTM, 24" Wires
FS-410-HT-M1-M1-0.7-P14-24	Stainless Steel Stem and Float, High Temperature , 0.7 SG, 1/8" NPTM, 24" Wires
FS-410-S-M1-M1-0.7-P14-36	Stainless Steel Stem and Float, Standard Temperature , 0.7 SG, 1/8" NPTM, 36" Wires
FS-410-HT-M1-M1-0.7-P14-36	Stainless Steel Stem and Float, High Temperature , 0.7 SG, 1/8" NPTM, 36" Wires
FS-410-S-M1-M1-0.7-P14-48	Stainless Steel Stem and Float, Standard Temperature , 0.7 SG, 1/8" NPTM, 48" Wires
FS-410-HT-M1-M1-0.7-P14-48	Stainless Steel Stem and Float, High Temperature , 0.7 SG, 1/8" NPTM, 48" Wires

FS-410 Replacements / Accessories

Please order separately, by part number.

Description	Part Number
1" Float, 316 SS, Standard Temp; Quantity 5	200329
1" Float, 316 SS, High Temp; Quantity 5	200330
E clip, 316 SS; Quantity 20	200331

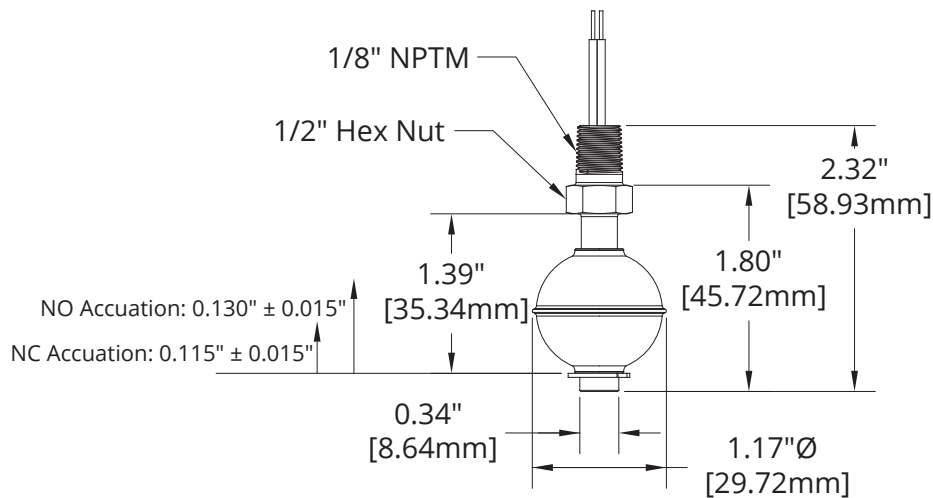

Model Configuration Options



Model Number: FS-410 - $\frac{\quad}{A}$ - $\frac{M1}{B}$ - $\frac{M1}{C}$ - $\frac{0.7}{D}$ - $\frac{P14}{E}$ - $\frac{\quad}{F}$

A. Operating Temperature

- S**[▲] Standard Range (-40 - 187°C)
- HT** High Temperature Range (-40 - 260°C)*

B. Stem Material

- M1**[▲] 316 Stainless Steel

C. Float Material

- M1**[▲] 316 Stainless Steel

D. Float Specific Gravity

- 0.7**[▲] 0.7 Specific Gravity

E. Fitting Type

- P14**[▲] 1/8" NPTM

F. Wire Length

- $_$ Wire Length in Inches (24 - 99)

Note: *Indicates this option is only available with CSA General Purpose ratings.