

Hinge Interlock Safety Switch Type: IDIS-2

FEATURES:

IDEM IDIS-2 Compact Hinge Safety Interlock switches are designed to provide position interlock detection for moving guards.

They are designed to fit to the hinged axis of machine guard doors. The switch body fits to the door frame and the leaf actuator fits to the door.

The rugged Stainless Steel actuator profile is designed to fix to the door and provide a positively operated not easily defeatable interlock mechanism. They can be mounted unobtrusively away from direct vision or contact.

The compact body and 22mm fixing profile make them easy to install where space is restricted.

The head can be rotated through 90 degree increments to provide ease of mounting in 4 positions.

Contact blocks are replaceable with optional slow or snap break operation.



Universal fitting - Opening Angle 180 degrees for swing doors

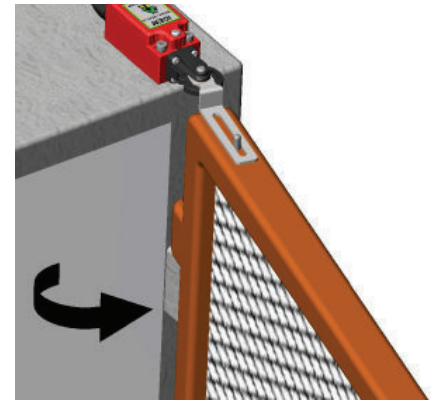
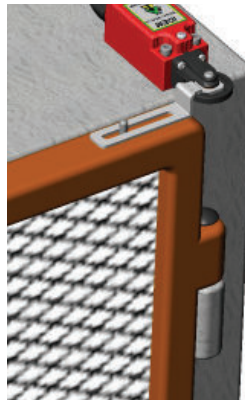

DIMENSIONS:

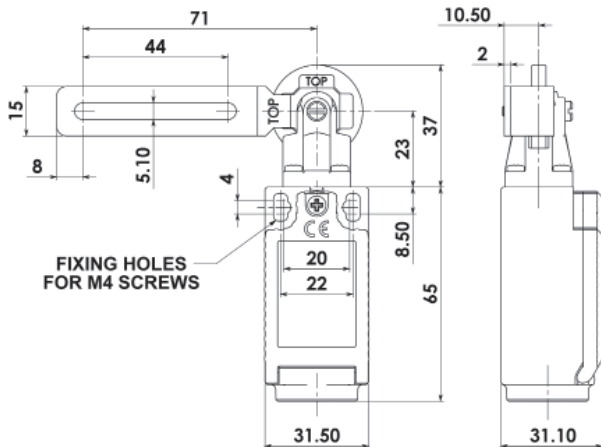

Standards: ISO14119 EN60947-5-1 EN60204-1
ISO13849-1 EN62061 UL508

Safety Classification and Reliability Data:

Mechanical Reliability B10d	2.5 x 10 ⁶ operations at 100mA load
ISO13849-1	Up to PLE depending upon system architecture
EN62061	Up to SIL3 depending upon system architecture
Safety Data – Annual Usage	8 cycles per hour/24 hours per day/365 days
	MTTFd 356 years
Utilization Category	AC15 A300 3A
Thermal Current (Ith)	10A
Rated Insulation/Withstand Voltages	600Vac/2500Vac
Actuator Rotation for Positive Opening	7 degrees 0.5Nm
Materials	UL Approved Glass Fibre Polyester
Enclosure Protection	IP67
Operating Temperature	-25C +80C
Vibration	IEC 68-2-6 10-55Hz + 1Hz
Conduit Entry	Excursion 0.35mm 1 octave/min
Fixing	Various (See Sales Number)
	2 x M4

CONTACT BLOCK OPTIONS:

Slow Make Break 2NC 1NO

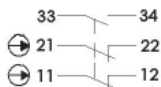

Slow Make Break 3NC

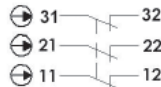

Snap Action 1NC 1NO

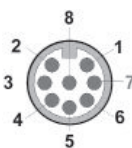
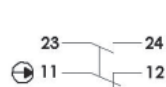

Switch Circuit	Quick Connect (QC) M12 8 Way Male (on Flying Lead 250mm) Pin View from Switch
11/12	1 7
21/22 or 23/24	6 5
33/34 or 31/32	4 3



FEMALE QC LEADS	LENGTH	SALES NUMBER
M12 8 Way	5m (15ft)	140101
M12 8 Way	10m (30ft)	140102

SALES NUMBER	CONTACTS	M20	1/2" NPT	QC M12 8 WAY
Universal Actuator	2NC 1NO	192001	192002	192022
Universal Actuator	3NC	192004	192005	192023
Universal Actuator	1NC 1NO Snap	192007	192008	192024

Gold Plated Contacts available for low power circuits (5V 5mA).
Add GC to Sales Number e.g. 192001-GC