

Achrovid™

Video-Dedicated Microscope Objectives

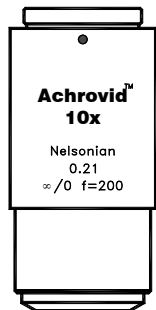
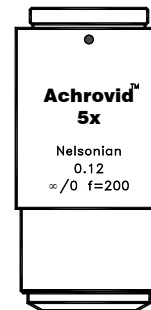
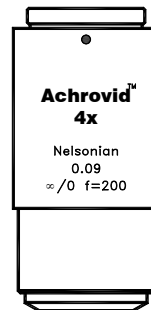
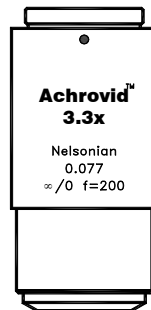
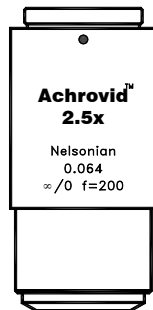
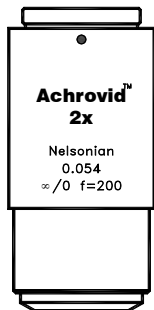

Achrovid™ Objectives

General Description: Although video inspection microscopes play an essential role in high magnification process monitoring and machine vision, they have invariably been equipped with objectives primarily designed for visual purposes. In video terms, such objectives have stated numerical aperture (N.A.) ratings that are more *theoretical* than practical. This is because “visually-dedicated” objectives “presume” that an end-user will constantly monitor each image to obtain a proper balance between contrast and resolution—through either an adjustment of condensing optics, a variation in aperture—or both. Unfortunately, it is impractical to monitor each image and adjust this balance on an individual basis in automated video applications or where many objects are being constantly examined. Moreover, the cross-over point between resolution and contrast occurs at less than full aperture (full N.A.).

The Achrovid Series—which presently consists of six objectives ranging from 2x, 2.5x, 3.3x, 4x, 5x to 10x—were developed to overcome these limitations. To do so, the Achrovid objectives were designed upon criteria originally developed by E.M. Nelson. This assures the best possible maximization of contrast and resolution for video applications. As a result, Infinity-Photo-Optical Company has developed the first range of specifically “video-dedicated” microscope objectives. Even though their stated N.A. ratings are somewhat lower than traditional “visually-dedicated” objectives, the Achrovids achieve what is considered to be a more usable and pleasing image without complication or any need to individually monitor each successive image for best results.

All Achrovid objectives are mounted via the common “M” thread (26mm/Whitworth) and are therefore compatible with all “M”-thread instruments. They were specifically designed for all Infinity-Photo-Optical Company products that accept external microscope objectives (InfiniTube™, Model KC/S™, CentriMax/S™ and Model K2/SC) by means of an M26 to M27 Adapter. All have 37mm working distances—except the 10x which has a working distance of 17.3mm.

The Achrovid Series represents a breakthrough in consistent, trouble free use coupled with high performance image quality. In addition, they are priced below most—if not all—of their “visual-dedicated” counterparts.

ACHROID OBJECTIVES

Achroid		Achroid 2x	Achroid 2.5x	Achroid 3.3x	Achroid 4x	Achroid 5x	Achroid 10x
Direct	WD mm	37	37	37	37	37	17.5
	Mag	2.00	2.50	3.30	4.00	5.00	10.00
	FOV 1/2"	3.20	2.56	1.94	1.60	1.28	0.64
	FOV 1/3"	2.40	1.92	1.45	1.20	0.96	0.48

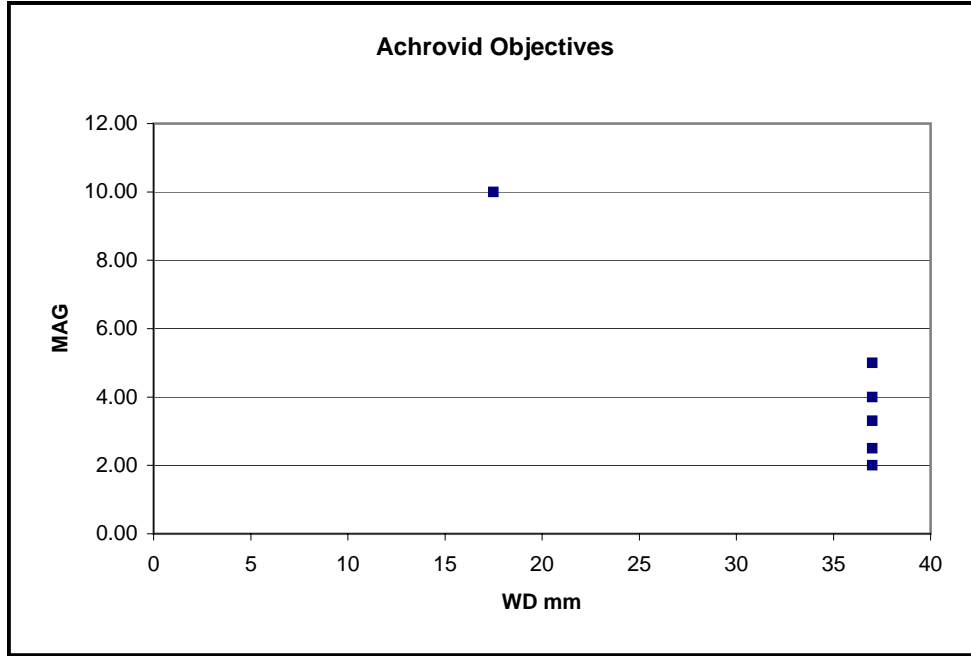

Achrovid-Objectives OPTICAL RESOLUTION DATA

Achrovid-Objectives	2x	2.5x	3.3x	4x	5x	10x
WDmm	37	37	37	37	37	17.5
MAG	2.00	2.50	3.30	4.00	5.00	10.00
NA	0.054	0.064	0.077	0.09	0.12	0.21
Resolution (lpmm)	162	192	231	270	360	630
Resolution (microns)	6.2	5.2	4.3	3.7	2.8	1.6
DOFmm	0.19	0.13	0.09	0.07	0.04	0.01

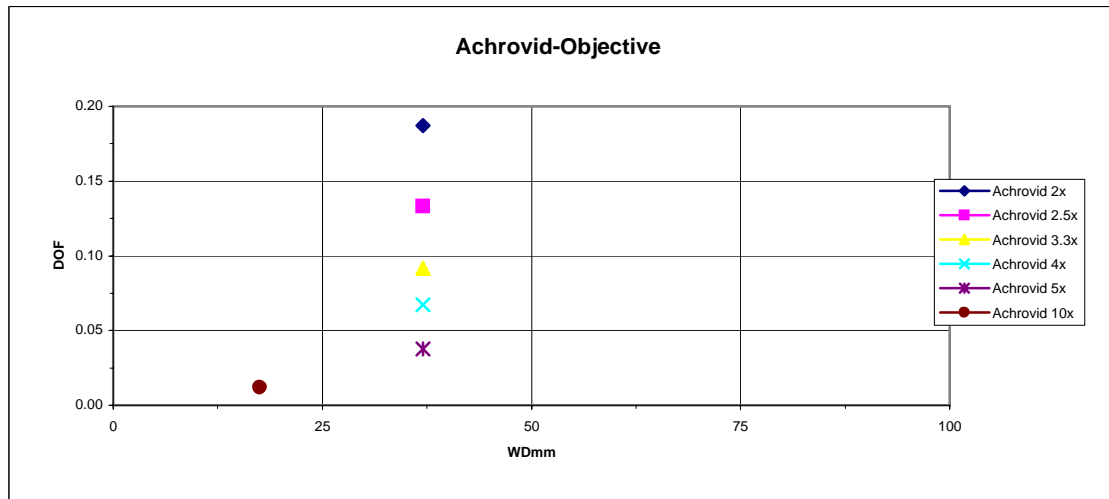
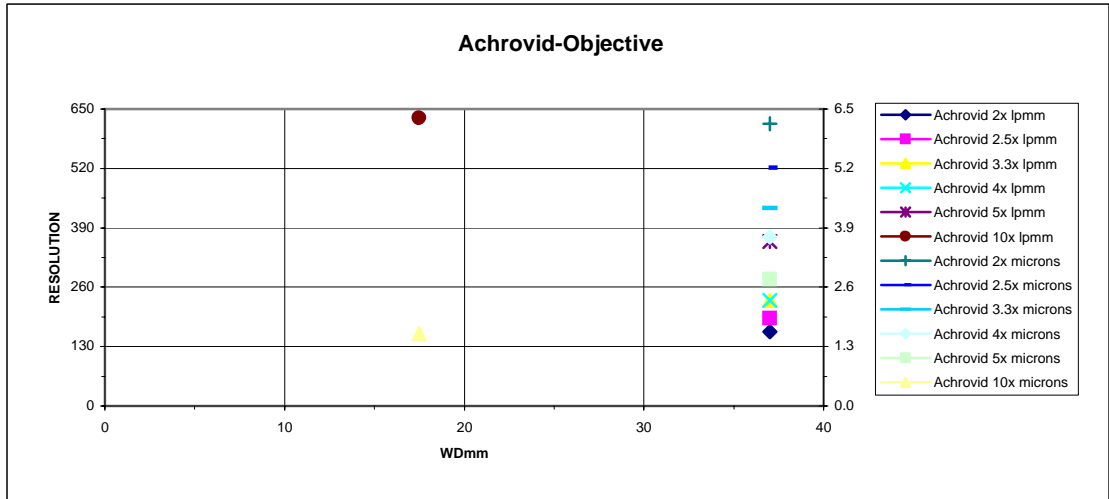



REVISIONS				
ZONE	REV	DESCRIPTION	DATE	APPROVED

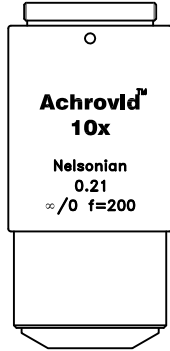
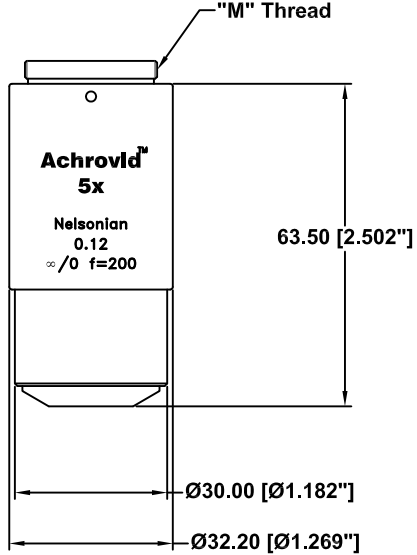
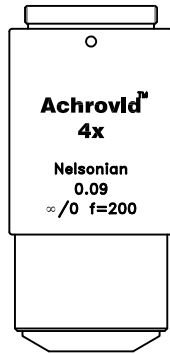
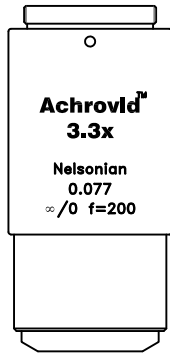
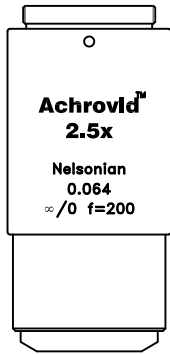
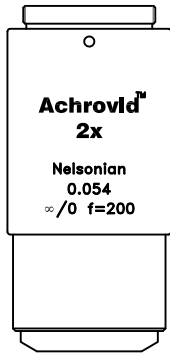

Note:
Achrovids 2x, 2.5x, 3.3x, 4x and 5x have a working distance of 37mm. Achrovid 10x has a working distance of 17.30mm.

<p>ALL DIM ARE mm [inches] AND ARE FOR REFERENCE ONLY AND ARE SUBJECT TO CHANGE.</p>		<p>INFINITY Photo-Optical Company www.infinity-usa.com</p>		
		<p>ACHROID RANGE</p>		
Date: 09/28/00 MB	SIZE B	FSCM NO.	DWG NO. -	REV -
Modified:	SCALE NONE	-	SHEET 1 OF 1	





REVISIONS				
ZONE	REV	DESCRIPTION	DATE	APPROVED

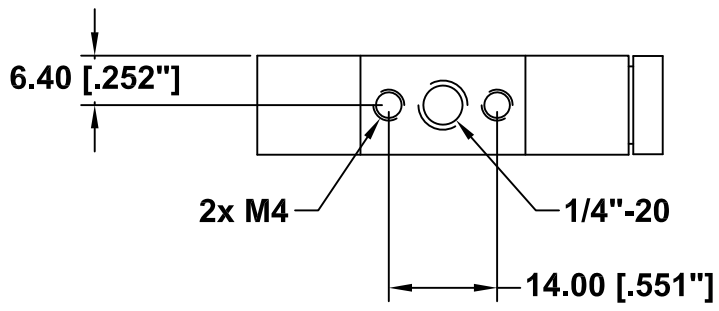
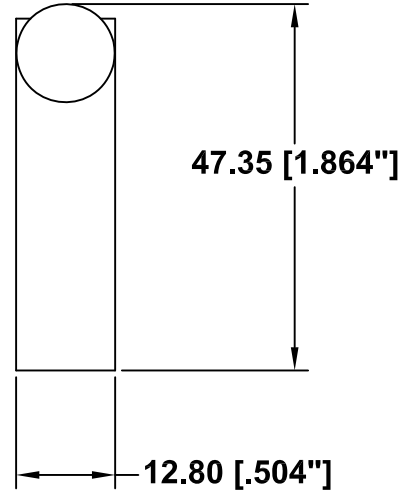
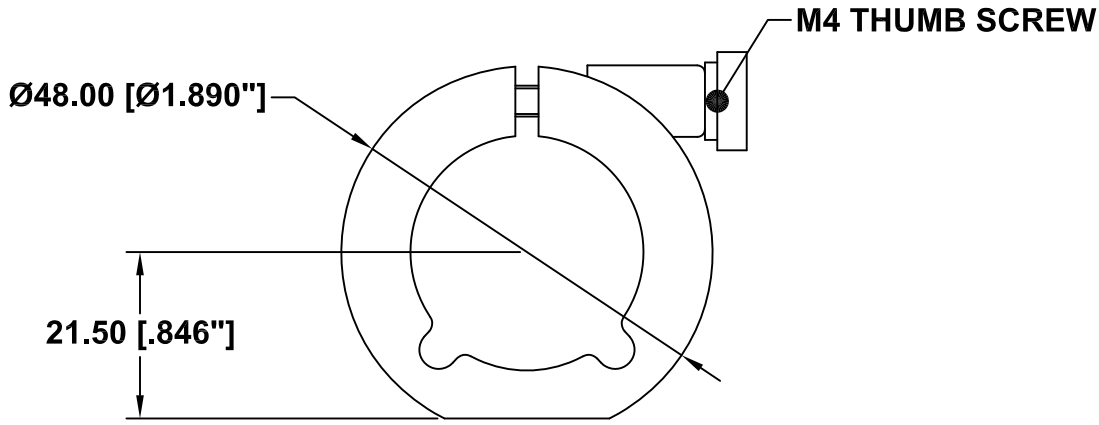

This drawing is for informational purposes only. No other rights or privileges are granted or implied.

ALL DIM ARE mm [inches] AND ARE FOR REFERENCE ONLY AND ARE SUBJECT TO CHANGE.

 **INFINITY** Photo-Optical Company
www.infinity-usa.com

SMALL MOUNTING CLAMP

Date: 03/19/01 MB		SIZE A	FSCM NO.	DWG NO. 990 171	REV A
Modified: 04/06/01 MB		SCALE NONE	SHEET 1 of 1		



INFINITY PHOTO-OPTICAL COMPANY LIMITED WARRANTY

INFINITY PHOTO-OPTICAL COMPANY hereby warrants its products to be free from defects in workmanship or materials for the warranty period set forth below. INFINITY PHOTO-OPTICAL COMPANY, at its option, shall repair or replace the defective product without cost to the purchaser, and such repair or replacement shall be the full extent of this express limited warranty. INFINITY PHOTO-OPTICAL COMPANY shall not be liable for any other damages either direct or consequential.

This warranty is made to the original purchaser, and is effective only on new equipment purchased from INFINITY PHOTO-OPTICAL COMPANY, or a dealer authorized by INFINITY PHOTO-OPTICAL COMPANY to sell the product.

This warranty is valid only when the product is returned to the authorized dealer from whom it was purchased, or returned directly to INFINITY PHOTO-OPTICAL COMPANY, freight prepaid, with proof of date of purchase.

This warranty does not extend to any defect, malfunction or failure caused by misuse, abuse or the use of the product with equipment for which it may not have been intended. Any unauthorized repair voids this warranty.

The warranty period for all products manufactured by INFINITY PHOTO-OPTICAL COMPANY is five (5) years from date of original purchase. Parts or components made or sourced from other manufacturers shall be solely covered by that manufacturer's warranty.

The warranty contained herein is the only warranty made by INFINITY PHOTO-OPTICAL COMPANY. Any implied warranty of merchantability and/or fitness for a particular purpose is expressly excluded from this warranty. INFINITY PHOTO-OPTICAL COMPANY shall not be liable for any expense, loss, incidental or consequential damages which may arise in connection with the use of this equipment. Recovery under this warranty is limited to repair or replacement of the equipment as provided above.

INFINITY PHOTO-OPTICAL COMPANY reserves the right to modify designs, equipment and accessories without notice.

RETURNING INFINITY PRODUCTS FOR SERVICE

Warranty Repairs:

If you have reason to think something is wrong or functioning improperly with your Infinity Photo-Optical product under the terms of the Warranty, please contact us to explain the problem. We can not accept items sent to us without first discussing the problem and providing you with a return merchandise authorization (RMA). Customer is responsible for delivery charges to us. We will examine the product and inform you whether or not the Warranty applies. If so, we will repair/replace the item to factory specifications free of charge. Return delivery charges will be paid by us. If the item(s) is/are deemed out of Warranty, we will advise if repairs can be made at a quoted charge. If customer refuses to authorize a charged repair, item will be returned at the customer's expense.

Repairs of Out of Warranty Products:

Often, we get requests to fix or repair products which are clearly older models out of Warranty. Before attempting to send such to us, please contact Infinity to go over what is desired. It is helpful to send us photos of the product so that we can see if there is a reasonable basis for a repair. Often, older instruments are "inherited" in a department and may have been tampered with by previous users. Infinity products obtained second-hand may have missing parts. After obtaining an RMA as detailed above for Warranty repairs, we will examine the item(s) and provide you with an estimate of charges for repair and return delivery to a level of performance agreed upon. Sometimes it is not possible to cost-effectively repair a product that has been abused or disassembled. A slight cosmetic defect may not affect performance and if so, we will not repair or replace it unless instructed to do so at additional charges. Upon your authorization for us to perform the repair, you will be charged at the price previously quoted for the service and delivery charges involved.