

20D

Electro-mechanical allfluid pressure switches



- > -1 ... 100 bar
Port size: G1/2
- > Microswitch with gold plated contacts
- > Intrinsically safe operation
- > Electrical connection:
connector acc. to DIN EN 175301-803 (form A) or cable gland



Technical features

Medium:

For neutral, aggressive, non-flammable gases and fluids

Operating pressure:

-1 ... 100 bar (-14 ... ??? psi)

Repeatability:

±1% of final value
(depending on regulating pressure)

Port size:

G1/2

Media viscosity:

Up to 1000 mm²/s

Sealing:

≤10⁻⁷ mbar · l · s⁻¹

Pulsations:

Not permitted

Switching pressure difference/hysteresis:

Fixed or adjustable

Switching cycles:

20/min maximum

Life cycle of mechanical parts:

10⁷ switching cycles

Switching element:

Microswitch with gold plated contacts

Shock-/vibrations (to avoid if possible):

4 g max. (sinusoidal) / 5 Hz max.

Mounting position:

Optional

Degree of protection:

IP65 for DIN EN 175301-803 (DIN 43650) form A connection

IP66 with cable gland

Electrical connection:

DIN EN 175301-803 (DIN 43650) form A or cable gland

Weight:

See table below

Ambient/Media temperature:

Ambient:

-25 ... +80°C (-13 ... +176°F) Media:

-10 ... +100°C (14 ... +212°F)

Air supply must be dry enough

to avoid ice formation at

temperatures below +2°C

(+35°F)

Materials:

Housing: aluminium diecast

Sensor: stainless steel

Sealing: stainless steel-bellows

Technical data

Standard models — 181xxxx (fixed switching pressure difference)

Electrical connection acc. to DIN EN 175301-803, form A

Symbol	Pressure range *1)		Over pressure *2)		Switching pressure difference		Upper range maximum		Weight		Model
	(bar)	(psi)	(bar)	(psi)	Lower range minimum (bar)	(psi)	(bar)	(psi)	(kg)	(lbs)	
	-1 ... 0	-14 ... 0	10	145	0,06	0.87	0,07	1.01	0,8	1.7	1810115
	-1 ... 1	-14 ... 14.5	10	145	0,08	1.16	0,9	13.0	0,8	1.7	1810215
	-1 ... 2,5	-14 ... 36.2	10	145	0,9	13.0	0,12	1.74	1,1	2.4	1810415
	0,05 ... 1	0.72 ... 14.5	10	145	0,07	1.01	0,08	1.16	0,8	1.7	1811115
	0,5 ... 4	7.2 ... 58	20	290	0,3	4.35	0,33	4.78	0,8	1.7	1811415
	0,5 ... 6	7.2 ... 87	20	290	0,3	4.35	0,35	5.07	0,8	1.7	1811515
	0,5 ... 10	7.2 ... 145	20	290	0,3	4.35	0,4	5.80	0,8	1.7	1811615
	1 ... 16	14.5 ... 232	50	725	0,7	10.1	0,8	11.6	0,8	1.7	1811715
	1 ... 25	14.5 ... 362	50	725	0,9	13.0	0,9	13.0	0,8	1.7	1811815
	5 ... 63	72 ... 913	85	1232	1,0	14,5	2,0	29.0	1,1	2.4	1811915

Connector is not in scope of delivery; special pressure ranges on request

*1) Setpoints should be ideally in the middle of the switching pressure range. Reference pressure = atmospheric pressure. Switching pressure must not exceed the indicated values.

*2) Short-term pressure peaks are not allowed to exceed this limit value during operations. Operative utilization of the limit value is not permitted. The limit value corresponds to maximum testing pressure.

Standard models – 180xxxx (adjustable switching pressure difference)

Electrical connection acc. to DIN EN 175301-803, form A

Symbol	Pressure range *1)		Over pressure *2)		Switching pressure difference						Weight		Model
					Lower range		Upper range		maximum				
	(bar)	(psi)	(bar)	(psi)	(bar)	(psi)	minimum (bar)	(psi)	(bar)	(psi)	(kg)	(lbs)	
	-1 ... 0	-14 ... 0	10	145	0,12	1.74	0,13	1.88	0,7	10.1	1,1	2.4	1800115
	-1 ... 1	-14 ... 14.5	10	145	0,13	1.88	0,14	2.03	1,0	14.5	1,1	2.4	1800215
	-1 ... 2,5	-14 ... 36.2	10	145	0,17	2.46	0,2	2.9	2,5	36.2	1,1	2.4	1800415
	0,05 ... 1	0.72 ... 14.5	10	145	0,08	1.16	0,11	1.59	0,7	10.1	1,1	2.4	1801115
	0,1 ... 2,5	1.45 ... 36.2	10	145	0,11	1.59	0,15	2.17	2,0	29.0	1,1	2.4	1801315
	0,5 ... 4	7.2 ... 58	20	290	0,3	4.35	0,4	5.8	2,5	36.2	1,1	2.4	1801415
	0,5 ... 6	7.2 ... 87	20	290	0,35	5.07	0,5	7.25	5,0	72.5	1,1	2.4	1801515
	0,5 ... 10	7.2 ... 145	20	290	0,4	5.8	0,8	11.6	8,0	116	0,8	1.7	1801615
	1 ... 16	14.5 ... 232	50	725	0,8	11.6	1,1	15.9	12,0	174	0,8	1.7	1801715
	1 ... 25	14.5 ... 362	50	725	1,0	14.5	1,5	21.7	20,0	290	1,1	2.4	1801815
	5 ... 63	72.5 ... 913	85	1232	3,5	50.7	4,5	65.2	20,0	290	1,1	2.4	1801915
	5 ... 100	72.5 ... 1450	150	2175	4,0	58.0	9,0	130.5	55,0	797	1,1	2.4	1801015

Connector is not in scope of delivery; special pressure ranges on request

*1) Setpoints should be ideally in the middle of the switching pressure range. Reference pressure = atmospheric pressure. Switching pressure must not exceed the indicated values.

*2) Short-term pressure peaks are not allowed to exceed this limit value during operations. Operative utilization of the limit value is not permitted. The limit value corresponds to maximum testing pressure.

Option selector

Switching pressure difference	Substitute
Adjustable	0
Fixed	1
Pressure range (bar)	Substitute
-1 ... 0	01
-1 ... 1	02
-1 ... 2,5	04
0,05 ... 1	11
0,1 ... 2,5	13
0,5 ... 4	14
0,5 ... 6	15
0,5 ... 10	16
1 ... 16	17
1 ... 25	18
5 ... 63	19
5 ... 100	10*



18★★★★

Electrical connection	Substitute
Interface for DIN EN 175301-803 form A connector *1)	10
Cable gland	15

*1) Connector is not in scope of delivery

*only for adjustable switching pressure difference

Accessories

Surge damper	Pressure port – reducing nipple	Brackets
		
Page 4	Page 4	Page 4
0553258 (stainless steel G1/4)	0550083 (G1/4 » G1/2)	0574772 (steel)
0574773 (brass/steel G1/4)	0574765 (G1/4 » 1/4 NPT)	0553908 (stainless steel)

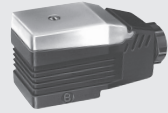
Connector DIN EN 175301-803	Connector with LED
	
Page 4	Page 4
0570110 (Form A)	0585418

Switching function

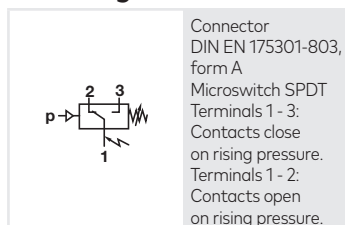

Switching capacity Commutator with gold plated contacts

Load level	Current type	Load type *2)	U min [V]	Max. permissible persistent current I _{max} [A] at U *1)				Electrical life-time
				M20 x 1,5 30 V	DIN EN 175301-803, form A 48 V	60 V	125 V	
Standard *3) (contractors, solenoids)	a.c.	Ohmic	12	0,1	0,1	0,1	0,1	≥ 2 x 10 ⁵ Switching cycles
	a.c.	Inductive, cos φ = 0,7	12	3	3	3	3	
	d.c.	Ohmic	12	5	1,2	0,8	0,4	
	d.c.	Inductive, L/R = 10 ms	12	3	0,5	0,35	0,05	
Minor *4) (electronic circuits)	a.c.	Ohmic	5 *5)	0,1				
	d.c.	Inductive, L/R = 10 ms	5 *5)	0,1	0,01			

Reference number: 20/min, Reference temperature: +20°C.

Spark quenching with diode with DC and inductive load:

I_{min} = 1 mA; I_{max} = 1,5 x I_{max} of table

Creepage and air paths correspond to insulation group B according to VDE Reg. 0110 (except contact clearance of microswitch).

*1) Higher currents (5 A max) will cause a reduction of the durability of the micro-switch contacts. Furthermore additional measures has to be taken to fulfil the EMV regulation 2004/108/EG by the manufacturer

*2) Spark quenching/overload protection will be necessary using inductive loads.

*3) Gold-plating not required as it would decay.

Max. perm. in-rush current (appr. 30 ms) I_{AC} = max. 15 A

*4) Gold-plating required (will not decay).

*5) Lower value of critical voltage guarantees sufficient contact safety. Lower voltages permissible under favourable conditions.

Recommended circuit Spark quenching and EMV intrinsically safe

1. Diode D in parallel to inductive load.

Observance of correct polarity (positive pole to cathode).

Dimensioning specifications for quenching diode:

Rated voltage at diode: $U_D \geq 1,4 \times U_s$

Rated current at diode: $I_N \geq I_{Load}$

Selection of a quick switching diode (recovery time $t_{rr} \leq 200$ ms)

2. RC link in parallel to load in parallel to switching contact.

Dimensioning principles:

R_L in $\Omega \approx 0,2 \times R_{Load}$ in Ω

C in $[\mu F] \approx I_{Load}$ in [A]

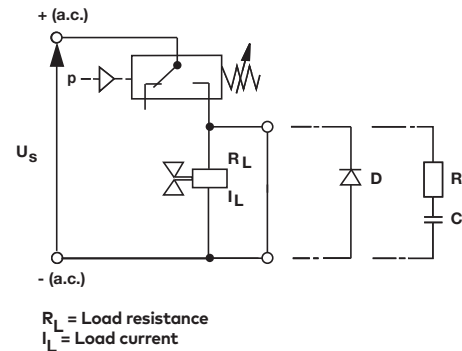

Drawings

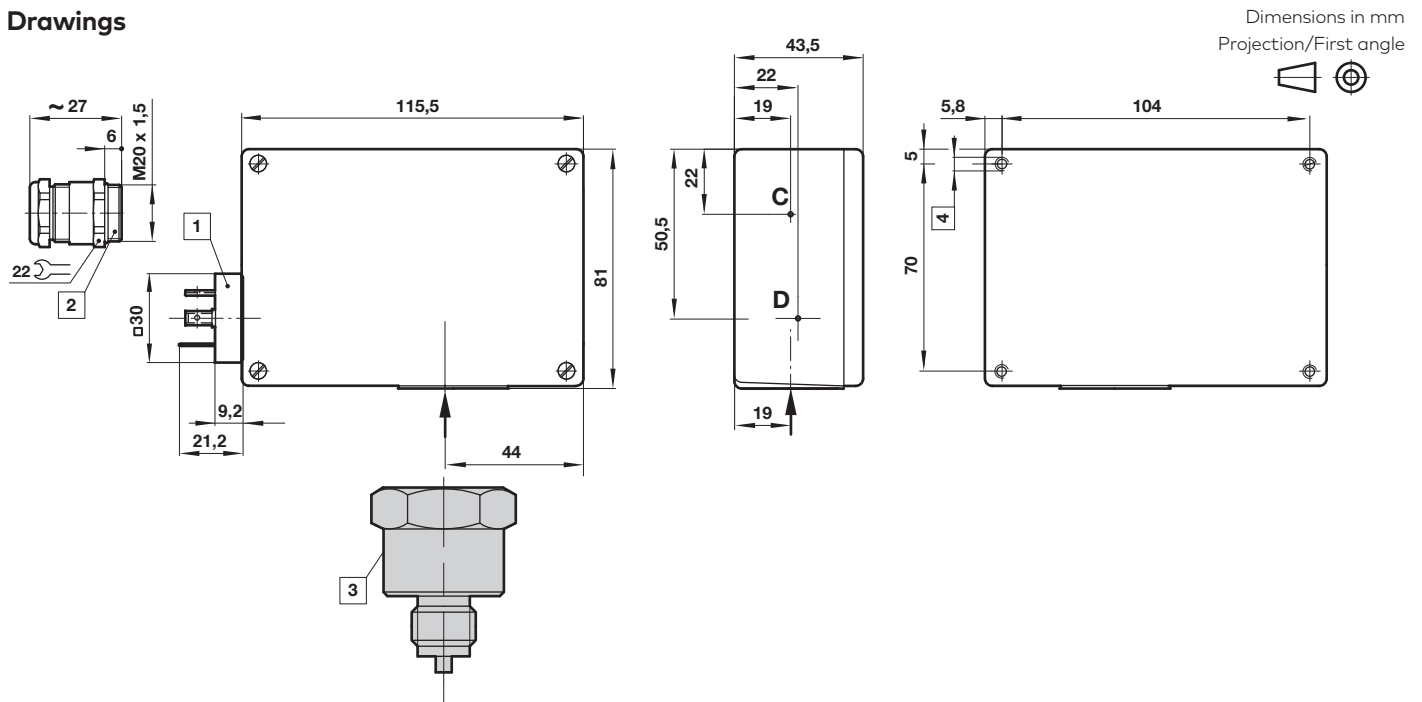

1 Electric standard interface, DIN EN 175301-803

Connector is not in scope of delivery

2 Alternative pressure switch range with cable gland

3 Fluid port

4 M4 x 10 deep

Fluid port

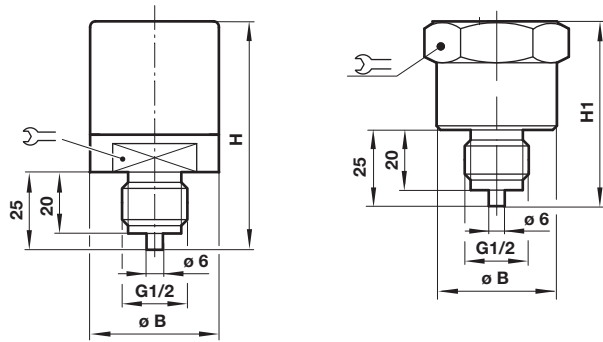

Dimensions in mm
Projection/First angle



Operating pressure (bar)	øB	H	H1	⌀
-1 ... 0/-1 ... 1/-1 ... 2,5/0,05 ... 1/0,1 ... 2,5	75	42	–	32
0,5 ... 4/0,5 ... 6/0,5 ... 10	75	42	–	32
1 ... 16/1 ... 25	43	–	37	32
5 ... 63	53	–	37	32
5 ... 100	62	–	37	32

Surge damper

Model: 0574773 (brass)
0553258 (stainless steel)
1.4301 AISI 304)

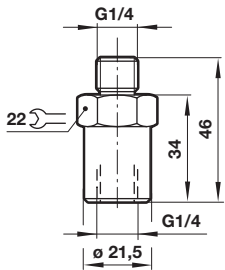

Pressure port/reducing nipple

Model: 0550083
(stainless steel 1.4305
AISI 303/304 S)

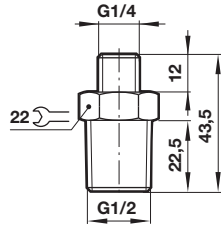

Model: 0574765
(brass)

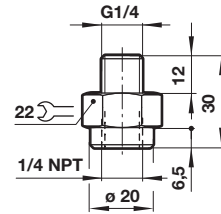

Connectors (black) with light indicator 3-pin + protective conductor

Connection acc. to
DIN EN 175301-803 (form A)
Voltage: 12 ... 28 V d.c./a.c.

Model: 0585418

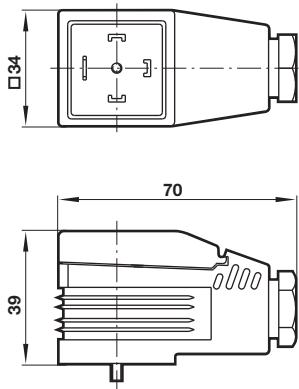

Brackets (2 brackets and 4 screws)

Model: 0574772 (steel)
0553908 (stainless steel 1.4301 AISI 304)

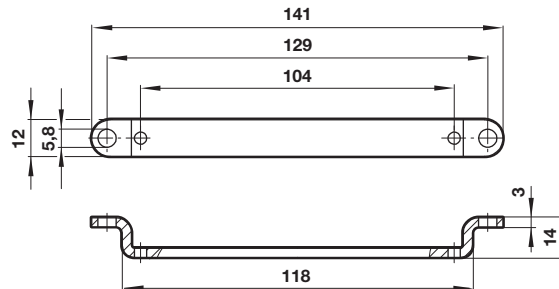

Warning

These products are intended for use in industrial compressed air and fluid systems only. Do not use these products where pressures and temperatures can exceed those listed under »Technical features/data«. Before using these products with fluids other than those specified, for non-industrial applications, life-support systems, or other applications not within published specifications, consult Norgren GmbH.

Through misuse, age, or malfunction, components used in fluid power systems can fail in various modes.

The system designer is warned to consider the failure modes of all component parts used in fluid power systems and to provide adequate safeguards to prevent personal injury or damage to equipment in the event of such failure. System designers must provide a warning to end users in the system instructional manual if protection against a failure mode cannot be adequately provided.

System designers and end users are cautioned to review specific warnings found in instruction sheets packed and shipped with these products.