

**GASTRON**

Headquarters / Engineering research laboratory :  
23 Gunpo Advanced Industry 1-ro(Bugok-dong), Gunpo-si, Gyeonggi-do  
Tel +82-31-490-0800 Fax +82-31-490-0801

Yeongnam business office / Plant :  
55 Gonghangap-gil, 85beon-gil, Gangseogu, Busan Metropolitan City  
Tel +51-973-8518 Fax +51-973-8519

E-mail : info@gastron.com

www.gastron.com

# GTD-5100F

## Instruction Manual



**GASTRON**

**GASTRON**

Read in detail for correct use.

# Gas & Flame Detection System

**GASTRON**



When abnormalities occur after purchasing the product,  
please contact the following address.

- Address : 23 Gunpo Advanced Industry 1-ro,  
Gunpo-si, Gyeonggi-do
- Tel : 031-490-0800
- Fax : 031-490-0801
- URL : www.gastron.com
- e-mail : info@gastron.com

## We sincerely thank you for purchasing the product of Gastron Co. Ltd.

Our Gastron Co.Ltd. is a company specialized in Gas detector and Gas Monitoring System, being recognized by many consumers due to the best quality and use convenience. We always enable you consumers to find desired products nearby and are ceaselessly studying and striving for development of Gas detectors satisfying customers. From now on, solve all anguishes concerning Gas detector with the products of Gastron Co. Ltd, We Gastron Co. will take a responsibility and give you satisfaction.

In the present instruction manual, operation method for Gas detector as well as simple methods for maintenance and repair, etc. are recorded. If you read it in detail and keep it well, for reference when you have questions, then it will give you much help.

- For accurate operation of Gas detector, check up and calibrate for more than once in every 6 months.  
(\* See No. 13 of KOSHA GUIDE : P-135-2013 / 8.3 paragraph on qualification and calibration)
- For accurate operation of Gas detector, checkup and calibration with calibration gas before measurement is recommended.
- When not calibrated, it may cause malfunction of the equipment due to problems resulting from Sensor aging.
- When the present instrument should be dismantled, those with professional skills for Gas detector should conduct the operation.
- For power supply cable, wire specifications should be determined by referring to the item of "Length of installed cable".
- For the contents on checkup and calibration of Gas detector, please use our company's engineering department, e-mail, or web site.

The present product and the product manual can be changed without advance notice for performance improvement and use convenience of the product.

\* KOSHA GUIDE : P-135/6-2018

Calibration should be executed at the periods required by the manufacturer, and should be executed every quarter unless there are separate calibration periods.

<b>1. Overview</b> .....	6	<b>7. System Mode</b> .....	18
<b>2. Configuration</b> .....	6	7.1. Mode Configuration .....	18
<b>3. Specification</b> .....	7	7.2. Detailed Menu Configuration .....	18
3.1. Basic Specifications .....	7	7.3. Configuration Mode .....	20
3.2. Mechanical Specifications .....	7	7.4. Program setting .....	22
3.3. Electrical Specifications (Standard Type) .....	8	7.5. Zero Calibration .....	23
3.4. Environmental Specifications .....	8	7.6. Span Calibration .....	24
<b>4. Name and Description of Each Part</b> .....	9	7.7. Alarm mode .....	25
4.1. Components .....	9	<b>8. Troubleshooting</b> .....	28
4.2. Front Display Configuration .....	11	8.1. Fault List .....	28
<b>5. Installation</b> .....	12	8.2. Warning List .....	28
5.1. Terminal Configuration .....	12	8.3. Recovery List .....	29
5.1.1. CN16 Terminal .....	12	<b>9. Interface Configuration</b> .....	30
5.1.2. CN17 Terminal .....	12	9.1. MODBUS RS485 .....	30
5.2. Power and 4-20mA Signal Configuration .....	13	9.1.1. Interface setting .....	30
5.2.1. Power and 4~ 20mA Source Configuration .....	13	9.1.2. MODBUS RS485 Register map .....	30
5.2.2. Power and 4~ 20mA Sink Configuration .....	13	9.2. MODBUS/TCP Interface .....	31
5.2.3. Power and 4~20mA 3Wire Sink Configuration .....	14	9.2.1. Interface setting .....	31
5.3. Alarm Terminal Configuration .....	14	9.2.2. MODBUS TCP/IP Register map .....	31
5.3.1. Trouble Relay Output Configuration .....	14	<b>10. Drawings and Dimensions</b> .....	34
5.3.2. Alarm1 Relay Output Configuration .....	14	10.1. GTD-5100F Cartridge Type .....	34
5.3.3. Alarm2 Relay Output Configuration .....	14	<b>11. Precautions before Installation</b> .....	35
5.4. RS-485 Terminal Configuration .....	15	11.1. Selecting a Place for Installation (Occupation Safety and Health Act Data) .....	35
<b>6. Operation</b> .....	16	11.2. Selecting a Site for Installation (High-Pressure Gas Safety Control Act Data) .....	35
6.1. Power On .....	16	11.3. Precautions during Installation .....	35
6.2. Measuring Mode .....	17	<b>12. Revision History</b> .....	37
6.3. Internal Mode Configuration .....	17		

GTD-5100F gas detector has been developed to detect gas leaked from industrial sites and various gases generated from factories, gas storages, and manufacturing processes that produce or use toxic gases by suction method and to prevent accidents in advance. GTD-5100F gas detector is installed in areas with gas leak hazards, continuously monitors gas leak at all times, and measures gas by sucking in the external air using a built-in pump. It displays measurements on 7-segment LED and supports various industrial interfaces including Analog 4-20 mA standard output, RS-485 and PoE. It provides relay contact signal in an event of gas leak alarm. Also, Analog 4-20 mA standard output is possible for connection up to max. 2500m of output signal transmission distance between the gas detector and receiver (When CVVS or CVVSB 1.5sq $\uparrow$  shield cable is used). RS-485 network signal can be transmitted up to 1000m (When a cable designated for RS-485 is used).

## 2. Configuration

This product can be installed in areas with gas leak hazards of all toxic and flammable gases. It is a gas detector with explosion-proof suction construction and built-in diaphragm pump and flow sensor. Gas measurement at installed site is displayed by built-in 4-digit FND. Internal construction consists of display part that shows measurements, main control part that measures and controls gas concentration and flow rate, and terminal part that output current output (Analog 4-20 mA), RS-485 network signal or Alarm signal.

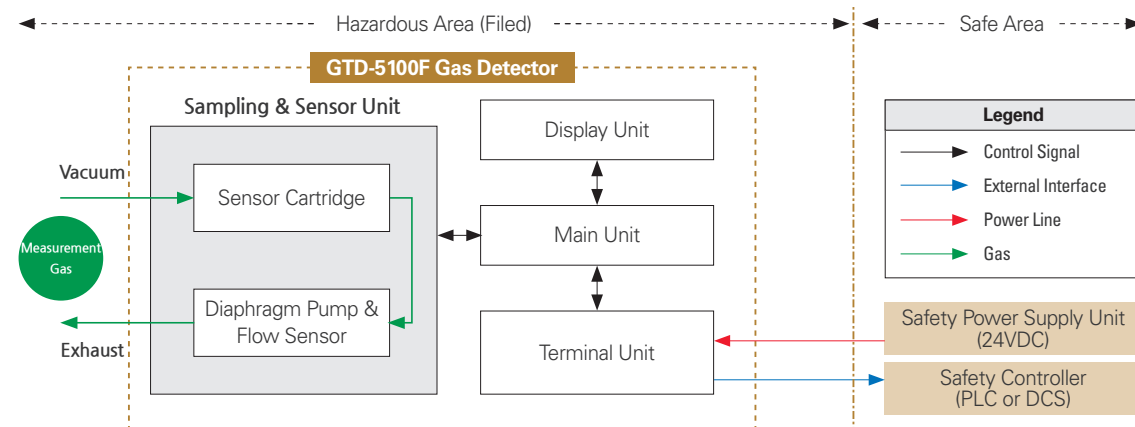

[Figure 1. GTD-5100F Overview]

## 3.1. Basic Specifications

ITEMS	SPECIFICATION	
Measuring Type	Auto Sampling type	
Measuring Type	Flexible Numeric Display LED	
Measuring Method	- Electrochemical / Cartridge - Catalytic / Cartridge - Semiconductor / Cartridge - Photoionization detector(PID) / Cartridge	
Detectible Gas	Flammable gas, Toxic gas, Oxygen (Note 1)	
Measuring Range	Capable to display 000.0 ~ 9999 (Note 1)	
Accuracy	≤ ±3% / Full Range	
Zero Drift	≤ 2% / Full Range	
Response Time	Depends on Sensor Module. Refer to Sensor Specification or Contact in case for Special Gas.	
Pump Type	Diaphragm Pump	
Flow Rate	100 ~ 1,000 ml (Normal 300~500ml / min)	
Approvals Classification	KCs: Ex d IIC T6 IP65	
Basic Interface	Analog 4-20mA current interface	
Cartridge Type Option	RS485, POE Interface, Pyrolyzer option	
Warranty	Transmitter	2Year
	Sensor	1Year

※ Note1. Refer to the measured gas list for measured gases and their ranges. Contact us for special gas.

## 3.2. Mechanical Specifications

ITEMS	SPECIFICATION
Explosion Proof type	Explosion-proof enclosure
Dimension	195 (W) × 139(H) × 154(D) mm
Weight including Sensor	App. 4.0kg
Mounting type	Wall mount
Mounting Holes	∅ 11 ±0.1
Cable inlet	3/4" PF ( 1/2" or 3/4" NPT )
Vacuum Tube (Sample gas vent/inlet)	1/4" Teflon Tube
Body material	Aluminum alloy

#### 3.3. Electrical Specifications (Standard Type)

ITEMS	SPECIFICATION	
Input Voltage(Standard) ※ Customer supplied PSU must meet requirements IEC1010-1 and CE Marking requirements.	Absolute min:	18V
	Nominal:	24V
	Absolute max:	31V
	Ripple maximum allowed:	1V pk-pk
Wattage	Max. wattage:	7.2W @+24 VDC
	Max. current:	300mA @+24 VDC
Analog output Current	0-20mA(500 ohms max load) All readings ± 0.2mA Measured-value signal: 4mA(Zero) to 20mA(Full Scale)	
	Fault:	0mA
	0-100% LEL:	4mA - 20mA
	100-109%LEL:	20mA - 21.4mA
	Over 110% LEL:	22mA
	Maintenance:	3mA
Analog output current ripple & noise max	±20uA	
Relay contact	Alarm1, Alarm2, Fault Relay Rated 1.0 A @ 30VDC or 0.5 A @ 125 VAC	
Wiring requirement	Power	CVVS or CVVSB with shield
	Analog	CVVS or CVVSB with shield
	RS485	STP(Shielded Twisted Pair)
Cable Connection Length	Analog	2500m
	RS485	1000m
EMC Protection:	Complies with EN50270	

#### 3.4. Environmental Specifications

ITEMS	SPECIFICATION	
Operation Temperature	Transmitter	-20 to 60 °C
	Sensor	Refer to Sensor Specification
Storage Temperature	Transmitter	-20 to 60 °C
	Sensor	Refer to Sensor Specification
Operation Humidity	Transmitter	5 to 99% RH (Non-condensing)
	Sensor	Refer to Sensor Specification
Pressure Range	90 to 110KPa	
Max. air velocity	6m/s	

#### 4.1. Components

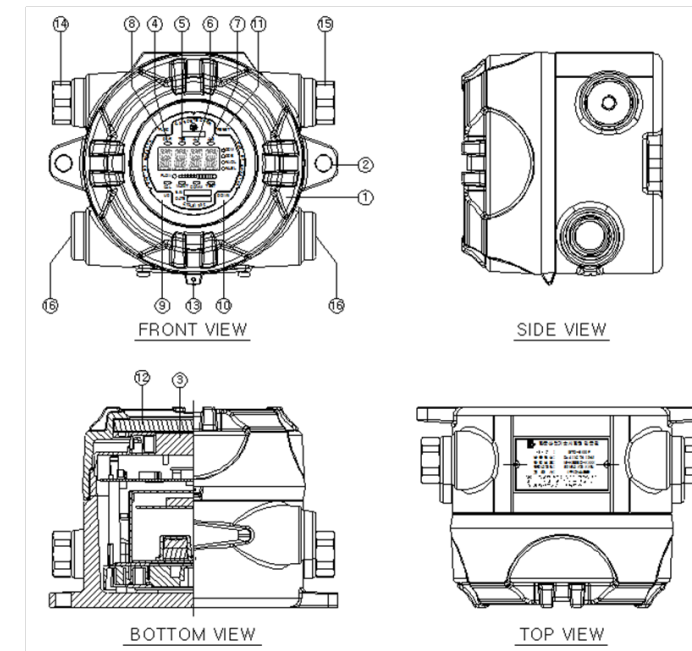

[Figure 2. GTD-5100F Components]

NO	NAME	DESCRIPTIONS
1	Case cover	Protects PCB Board and Sensor, etc built in Sensor and Housing from external environmental change and shock.
2	Mount Holes	It is mounting hole used for fixing the product.
3	LCD display	It displays gas concentration measurements from the sensor and setting modes during parameter settings in numbers and LED. (Refer to "Front Display Configuration" for detailed description.)
4	Power LED	When the power (DC 24V) is supplied normally, green LED lights on.
5	Trouble LED	Yellow LED lights on when it detects the sensor and flow rate to be fault. It outputs trouble relay contact signal externally.
6	Alarm1 LED (Red)	When measured gas concentration exceeds set Alarm1 threshold, the LED lights on and relay contact signal is outputted externally (if it is set). (Alarm1 level can be set arbitrarily in Alarm setting mode.)
7	Alarm2 LED (Red)	When measured gas concentration exceeds set Alarm2 threshold, the LED lights on and relay contact signal is outputted externally (if it is set). (Alarm2 level can be set arbitrarily in Alarm setting mode.)

## 4. Name and Description of Each Part

NO	NAME	DESCRIPTIONS
8	Function key	It is a key to convert or set a mode in function setting mode. When FUNC key is pressed for 2 sec or longer in measuring mode, it enters function setting menu mode. (Configuration, Program, Calibration, Alarm, Time, etc.)
9	Up key	It is a key to increase a set value in function setting mode.
10	Down key	It is a key to decrease a set value in function setting mode. When down key is pressed for 2 sec longer in measuring mode, it enters test mode (EMS: Emergency Maintenance System). The icon lights on then it flashes. In stand-by mode, pressing down key for 2 sec or longer releases it.
11	Reset key	To change into menu mode or measuring mode from function setting mode, use reset key to return.
12	Window Glass	It is a tempered glass that enables display of product status inside the housing.
13	Cover fixed screw	It is a screw that fixes the main body case and the front cover case.
14	Gas inlet	It is sample gas inlet port. (1/4" Tube)
15	Gas outlet	It is sample gas output port. (1/4" Tube)
16	Cable gland	It is power and signal cable inlet.

[Table 1. GTD-5100F Component Description]

## 4. Name and Description of Each Part

### 4.2. Front Display Configuration

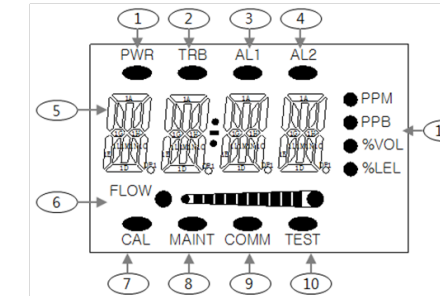

[Figure 3. Front Configuration]

NO	NAME	DESCRIPTIONS
1	Power LED(Green)	When the power (AC 24V 24V) is supplied normally, LED lights on.
2	Trouble LED	Displayed when fault is detected during gas detector self-test.
3	Alarm1 LED	Displayed during alarm1 setting or when an alarm1 is detected.
4	Alarm2 LED	Displayed during alarm2 setting or when an alarm2 is detected.
5	FND DISPLAY	It displays gas concentration measurements from the sensor and setting modes during parameter settings in numbers and icons.
6	FLOW LED	Displays the current flow rate in graph bar.
7	CAL LED	Displayed during calibration
8	MAINT LED	Displayed during engineering mode
9	COMM LED	Displayed for RS485 network connection
10	TEST LED	Displayed when running Maintenance mode
11	Display Unit	Displays Gas Measurement Unit

[Table 2. Front Configuration Description]

### 5.1. Terminal Configuration

- <Warning - Do not open when electrical current is flowing>
- Loosen the case cover fixing screw on the side of the detector and rotate the case cover in the opposite direction to remove it. This will bring up the Terminal PCB terminal.

#### 5.1.1. CN16 Terminal

- CN16 terminal consists of terminals for sensor power and 4-20 mA output.

NO	Terminal Name	Description
1	GND	Detector Power -
2	+24V	Detector Power +
3	GND	Detector Power -
4	mA	4~20mA Output Signal
5	VISO	Isolation power (used for 4-20 mA Sink mode configuration)

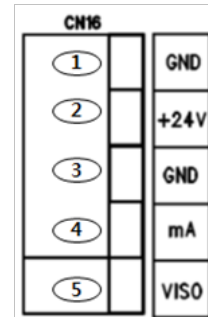

#### 5.1.2. CN17 Terminal

- CN17 terminal is constructed for RS485 and Alarm relay output.

NO	Terminal Name	Description
6	AL2 OUT	ALARM2 RELAY OUTPUT Terminal. Output mode is decided by J3 Jumper setting.
7	AL2 COM	ALARM2 RELAY COMMON Terminal
8	AL1 OUT	ALARM1 RELAY OUTPUT Terminal. Output mode is decided by J6 Jumper setting.
9	AL1 COM	ALARM1 RELAY COMMON Terminal
10	TRB OUT	Trouble RELAY OUTPUT Terminal. Output mode is decided by J7 Jumper setting.
11	TRB COM	TROUBLE RELAY COMMON Terminal
12	RS485 B	RS485 B Terminal
13	RS485 A	RS485 A Terminal
14	PY-	Pyrolyzer Power - Terminal
15	PY+	Pyrolyzer Power+ Terminal

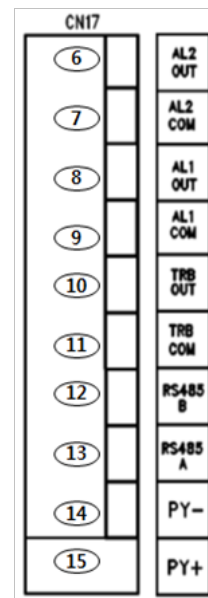

### 5.2. Power and 4-20mA Signal Configuration

- <Warning - Turn off power before connecting power terminal>
- When using DC24V power, connect power to CN16(+24V, GND).
- Shield cables of 1.5 sq and higher must be used.

#### 5.2.1. Power and 4~ 20mA Source Configuration

- Connect 4-20 mA signal terminal at PLC side to 'mA' of GTD-2000Tx. GND terminal is used in common with power. Then connect the Jumper-Pin at J1 of the Main Board.

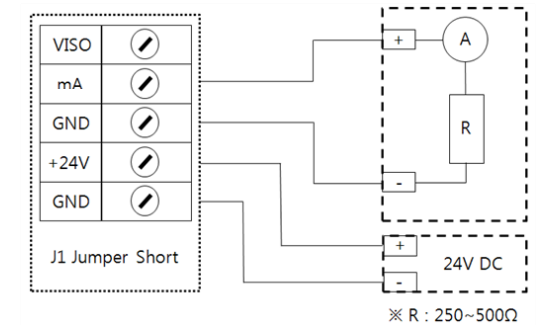

[Figure 4. 4-20mA Source Driver Configuration]

#### 5.2.2. Power and 4~ 20mA Sink Configuration

- Connect (+) and (-) terminals for 4-20 mA sink output at PLC side to E.+V terminal and 'mA' terminal, respectively. Then, connect J1 Jumper to Sink side.

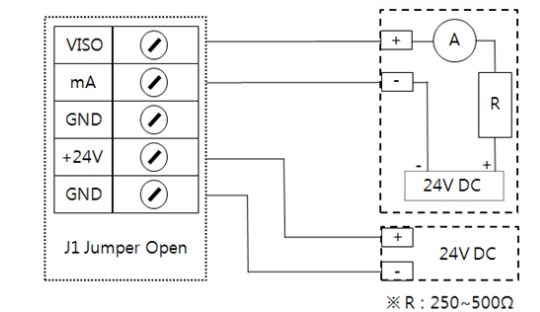

[Figure 5. 4~20mA Sink Driver Outline]

5.2.3. Power and 4~20mA 3 Sink Configuration

- Connect (+) and (-) terminals for 4-20 mA sink output at PLC side to VISO terminal and power (24V DC) (-) terminal, respectively. Then, connect 'mA' terminal to 'GND' terminal.
- OPEN J1 Jumper-Pin

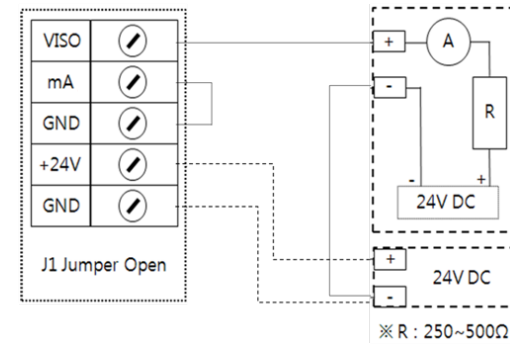

[Figure 6. 4~20mA 3 Wire Sink Driver Outline]

5.3. Alarm Terminal Configuration

- Connect Trouble and Alarm Relay connected to CN17 terminal as configuration shown below.

5.3.1. Trouble Relay Output Configuration

Terminal Name	FAULT RELAY CONTACT	JUMPER Setting
TRB-OUT	Normal Close Mode	J7 Jumper NC on
	Normal Open Mode	J7 Jumper NO on
TRB-COM	Common	-

5.3.2. Alarm1 Relay Output Configuration

Terminal Name	FAULT RELAY CONTACT	JUMPER Setting
AL1-OUT	Normal Close Mode	J6 Jumper NC on
	Normal Open Mode	J6 Jumper NO on
AL1-COM	Common	-

5.3.3. Alarm2 Relay Output Configuration

Terminal Name	FAULT RELAY CONTACT	JUMPER Setting
AL2-OUT	Normal Close Mode	J3 Jumper NC on
	Normal Open Mode	J3 Jumper NO on
AL2-COM	Common	-

5.4. RS-485 Terminal Configuration

- Connect RS-485A and RS-485B of CN17 with MODBUS Master terminal as shown below.

Device Terminal Name	Master Terminal Name	Notes
RS485A	'TRXD+' or 'A' or 'P'	
RS485B	'TRXD-' or 'B' or 'N'	

Note1) Use cable designated for RS-485

Note 2) When there is no RS485 option available for GTD-5000F, the following function does not run.



### 6.1. Power On

- After checking wiring and power voltage, turn on the power switch located at the front part.
- Power LED (Green) light on and "SELF" message, indicating that version information, equipped sensor type (CT-S: Cartridge type Sensor), and sensor data are being loaded, is displayed. After displaying "R180~R001", it enters measuring mode.
- It takes approx. 180 sec (1800 sec for O2 detector). When RST (reset key) is pressed when "R180~R001" is flashing, "R04~R01" is displayed and it returns to measuring mode.

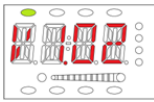
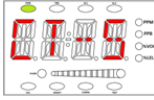
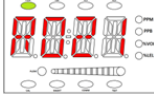
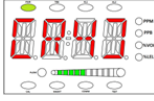
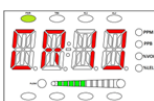
	- When the power switch turns ON, PWR LED lights on and "UX.XX" Firmware Version information is displayed for 1 sec on FND (concentration display part).
	- Sensor type that is equipped in the model is displayed. - CT-S: Cartridge type Sensor
	- During the initial exchange of information between sensor and main unit, "R180~R001" message is displayed for 180 sec. When RST KEY is pressed at this time, it immediately enters measuring mode. - For O2 detector, "1800~0001" is displayed and it immediately enters measuring mode when gas value is 20.9 +/- 3%.
 ~ 	- Upon completion of sensor warm-up, it counts from R4~R1 then enters measuring mode. - Count display is always displayed when it enters measuring mode from another mode.

### 6.2. Measuring Mode

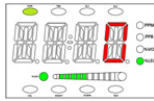
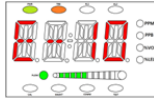
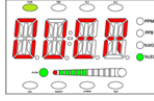
	- It displays gas concentration received from sensor on FND digital display in numbers and the current flow rate in bar graph.
	- When there is an error in sensor, messages from "E-10" to "E-34", etc. flashes and trouble LED (Orange) lights on. (8. (Refer to Section Error & Warning Message (Troubleshooting))
	- When input gas concentration from sensor is 10% higher than the set high scale value, "OUER" displays by flashing in 0.5 sec interval. - When gas concentration is detected to be above the alarm threshold and the alarm dwell time has passed, alarm function runs. - Alarm LED Lamp operation flashes in 0.5 sec interval while counting the alarm dwell time and lights on when it has passed the dwell time. - Alarm relay turns on when it has passed the alarm dwell time. - When Alarm Latch Type is in "ON" mode and alarm function runs, the alarm status and gas concentration value stays (displayed) at the maximum value. When gas concentration decreases below the alarm value, alarm does not get released and "RESET" key must be ran to release it. - When Alarm Latch Type is in "OFF", Alarm is released automatically in accordance to gas concentration.

### 6.3. Mode Configuration

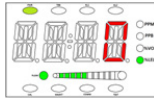
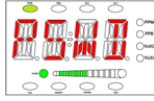
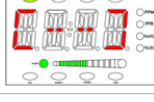
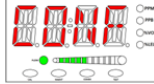
	- When "FUNC" key is pressed for 2 sec or longer in measuring mode, it enters password required step.
 	- In a password required step, "PSWD" (Passwword mode) and password input display ([ - ]) flashes in turns with 0.5 s interval. - Initial factory setting is ([ - ]) = [00] and the password can be changed from ([00]~[99]). Entering password followed by pressing FUNC (Function) key enters each mode. Using UP or DOWN key, each mode can be selected.
	- Using UP or DOWN key, it can enter internal mode. - Internal mode can be set for CONF, PRGM, CALB, ALARM, etc.

7.1. Mode Configuration

■ This device consists of the following menu configuration.

TYPE	Menu Display	Description	Notes
CONFIGURATION MODE	CONF	Internal Mode Configuration Setting	
PROGRAM MODE	PRGM	Gas Measurement Related Setting	
CALIBRATION MODE	CALB	Gas Calibration	
ALARM MODE	ALAM	Alarm Setting	
TIME MODE	TIME	Time Change	Factory Mode
SENSOR DATA MODE	S-DT	Sensor Data Output	Factory Mode
TEST MODE	TEST	Test Mode	Factory Mode
FLOW MODE	FLOW	Flow Operation Setting Mode	Factory Mode
MAINTENANCE MODE	M-T	Internal Mode Configuration Setting	Factory Mode
NETWORK MODE	nEt	PoE related Ethernet Setting	Factory Mode
ADJUST MODE	ADJ	4-20 mA output and flow correction	Factory Mode

[Table 3. Mode Configuration]

7.2. Detailed Menu Configuration



■ Entire menu configuration for the device is as follows.



LEVEL1	LEVEL2	LEVEL3	DEFAULT
CONF	485	It automatically displays YES/NO depending on equipment of the option board. (When equipped, YES)	-
	HART		-
	ADD(Address)	OFF, 1~64 (Address for 485 Modbus Network)	1
	PSWD(Password)	0~99 (Password Setting)	00
	C-TM(Calibration Time)	OFF, 1~12 (Gas detector Calibration Frequency Setting)	OFF
	SKIP(Skip)	OFF, 1~20 (Restriction ratio for measured gas value. Runs at 20% of full range)	03%
	PYRO(Pyrolyzer)	ON, OFF (Pyrolyzer Consumption Current Use Setting)	OFF
	V1.25(Version)	Firmware Version Display	-
PRGM	END	-	-
	UNIT	PPM, PPB, %VOL, %LEL	%LEL
	DP-S(Decimal Point)	1000, 100.0, 10.00, 1.000 (Measurement Digit Setting)	100
	H-SL(High Scale)	1~9999 (Measurement Full Range(High Scale) Setting)	100
	END	-	-

LEVEL1	LEVEL2	LEVEL3	DEFAULT
CALB	ZERO	NO, YES	NO
	0	Current Zero Measurement	-
	WAIT(Wait)	-	-
	GOOD(Good)	Good, Fail	-
	0	Measurement after zero calibration	-
	SPAN	NO, YES	NO
	50	Standard gas value setting for span calibration	50%/F.R.
	45	Current Measurement	
	WAIT(Wait)		
	GOOD(Good)	For successful calibration, Good. For failed calibration, Fail.	-
	50	Measurement after span calibration	-
	END	-	-
	ALAM	LACH(Latching)	ON, OFF
EN-Z(Energizer)		ON, OFF	OFF
AL-1(Alarm 1)		Set to 90% of 1~ Full Range	20%/F.R.
1H/1L (Alarm Operation Direction)		H: Rising Alarm / L: Lowering Alarm	1H
1H00/1L00(Dead band)		0~10%/Full Range	1H00
AL1T(Alarm1 time)		0~30sec(Alarm Dwell Time)	1
A1RL(Alarm1 Relay)		ON, OFF (Relay Use Setting)	ON
AL-2(Alarm 2)		Set to 100% of 1~ Full Range	40%/F.S.
2H/2L (Alarm Operation Direction)		H: Rising Alarm / L: Lowering Alarm	2H
2H00/2L00(Dead band)		0~10%/Full Range	2H00
AL2T(Alarm2 time)		0~30sec(Alarm Dwell Time)	1
A2RL(Alarm2 Relay)		ON, OFF (Relay Use Setting)	ON
END		-	-

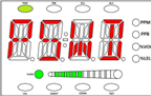
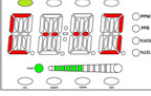
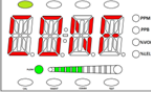
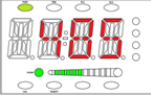

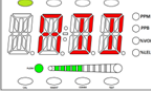
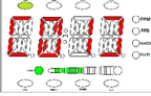
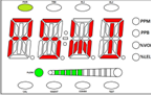
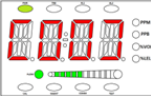

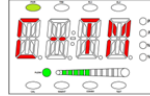
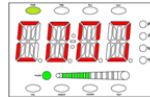
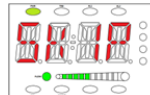
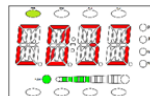
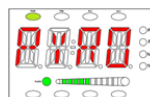
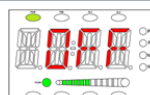
[Table 4. Mode Table]

### 7.3. Configuration Mode

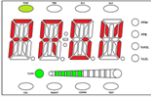
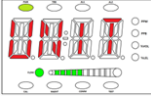
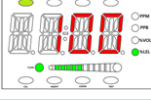
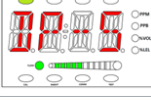
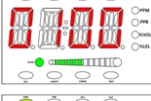

	- When "FUNC" key is pressed for 2 sec or longer in measuring mode, it enters password required step.
	- In a password required step, "PSWD" (Password mode) and password input display ([ - ]) flashes in turns with 0.5 sec interval. MAINT LED turns on.
	- Initial factory setting is ([ - ]) = [00] and the password can be changed from ([00]~[99]). Entering password followed by pressing FUNC (Function) key enters each mode. Using UP or DOWN key, each mode can be selected.
	- Using UP key or DOWN key to select "CONF" (Configuration mode) then press "FUNC" key to enter main unit configuration mode.
	- RS485 Modbus board equipment status can be confirmed.
	- When RS485 board is equipped, 485 and YES flashes alternately. - When RS485 board is not equipped, 485 and NO flashes alternately.
	- A designated address for gas detector is required for data network (RS-485, etc.) It is a mode that sets address. - Pressing "FUNC" KEY enters address setting function.
	- For address input, pressing UP key or DOWN key increases or decreases number. It can be set in a range between 1~64 and default is 1. - When a desired address (no.) is displayed, press "FUNC" key to set it and enter the next item.
	- It is PSWD (Password) Mode. - It is a password mode that gives authorization to change gas detector data. Pressing UP key or DOWN key increases or decreases password number, respectively.
	- Password can be set in a range between 00~99 and default is [00]. - When a desired password is displayed, press "FUNC" KEY to set it and enter the next item.

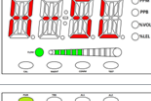
	- It is a mode that sets sensor calibration frequency in a unit of month. Pressing ▲"key or ▼"key increases or decrease number, respectively.
	- Calibration frequency can be set in a range of 01~12 month and default setting is OFF (not used). - When a desired month is displayed, press "FUNC" KEY to set it and enter the next item.
	- SKIP mode sets suppression % that displays '0' for gas concentration when displaying gas concentration. Pressing UP key or DOWN key increases or decreases % number, respectively. (Default: 3)
	- It can be set in between 1%~20% of the full range and default is set at 3%. - When a desired % is displayed, press "FUNC" KEY to set the restriction and enter the next item.
	- It sets pyrolyzer usage and UP key or DOWN key is used to set whether to use it or not. - It does not apply to IR type.
	- Set to ON when using pyrolyzer and to OFF when it is not used. Press "FUNC" key to set selected mode and enter the next item.
	- It is a mode that displays program version. - Pressing "FUNC" key displays "End", which is the next item. When "FUNC" key is pressed again, it enters menu mode.
	- It means that it has completed setting and changing of the configuration mode. Pressing "FUNC" key changes to menu mode.

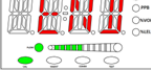

### 7.4. Program Setting

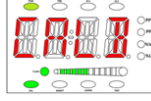
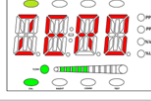
	<ul style="list-style-type: none"> <li>- When "FUNC" key is pressed for 2 sec or longer in gas concentration display mode, it enters menu selection mode.</li> <li>- UP key or DOWN key to select "PRGM" (Program mode) then press "FUNC" key to enter program configuration mode.</li> </ul>
	<ul style="list-style-type: none"> <li>- It is a mode that sets gas concentration measurement unit.</li> </ul>
	<ul style="list-style-type: none"> <li>- Pressing UP key or DOWN key changes the unit LED on the right. There are 4 types of measurement unit: PPM, PPB, %VOL, and %LEL. Default setting is %LEL.</li> <li>- When a desired unit icon is flashing, press "FUNC" KEY to set it and enter the next item.</li> </ul>
	<ul style="list-style-type: none"> <li>- "DP-S" (decimal point) message is displayed for setting decimal place for gas concentration number.</li> <li>- When "FUNC" KEY is pressed, it enters decimal setting mode.</li> </ul>
	<ul style="list-style-type: none"> <li>- Decimal point is used when it is necessary to change decimal point for measured range. Decimal point position is set by pressing UP KEY or DOWN KEY to change in 4 different options. (0.000, 00.00, 000.0, 0000)</li> </ul>
	<ul style="list-style-type: none"> <li>- When a desired decimal place is displayed, press "FUNC" KEY to set the decimal place and enter the next item.</li> </ul>
	<ul style="list-style-type: none"> <li>- "H-SL" (High scale) message is displayed for high scale setting function that sets the max. value of measuring range.</li> <li>- When "FUNC" KEY is pressed, it enters high scale setting mode.</li> <li>- High scale value is set to a range defined by domestic regulations as default.</li> </ul>
	<ul style="list-style-type: none"> <li>- High scale changes a set value according to measuring range. Scale value increases or decreases upon pressing UP KEY or DOWN KEY, respectively.</li> <li>- When a desired high scale is displayed, press "FUNC" KEY to set it and enter the next item.</li> </ul>
	<ul style="list-style-type: none"> <li>- It means that it has completed setting and changing of the program mode. Pressing "FUNC" key changes to menu mode.</li> </ul>

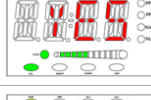
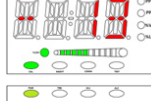
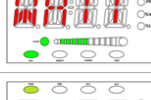
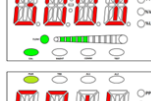
### 7.5. Zero Calibration

	<ul style="list-style-type: none"> <li>- When "FUNC" key is pressed for 2 sec or longer in measuring mode, it enters menu selection mode.</li> <li>- Use UP key or DOWN key to select "CALB" (Calibration mode) then press "FUNC" key to turn on CAL LED on bottom left and enter calibration mode.</li> </ul>
	<ul style="list-style-type: none"> <li>- It displays selection for Zero Calibration. When "FUNC" KEY is pressed, it enters zero setting mode.</li> </ul>
	<ul style="list-style-type: none"> <li>- Using UP key or DOWN key, select "YES" then press "FUNC" key to display gas concentration that is being measured currently.</li> </ul>
	<ul style="list-style-type: none"> <li>- Using a calibration tool, inject the standard gas into the sensor at a flow rate of 300 mL/min for 1 sec.</li> <li>- When the measurement is stable after gas injection, press "FUNC" key to automatically run Zero calibration and display "WAlT" message.</li> </ul>
	<ul style="list-style-type: none"> <li>- When the calibration is successful "GOOd" is displayed for 2 sec then it changes to calibration concentration display mode.</li> </ul>
	<ul style="list-style-type: none"> <li>- When the calibration is unsuccessful "FAIL" is displayed for 2 sec then it changes to calibration concentration display mode.</li> </ul>
	<ul style="list-style-type: none"> <li>- Pressing "FUNC" key in calibration concentration display mode immediately enters Span Calibration Mode. Pressing "RST" key returns to "CALB" (Calibration mode).</li> </ul>

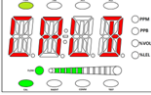
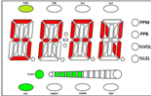
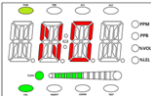
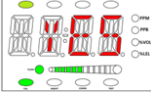
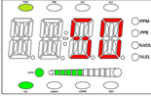
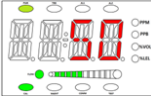
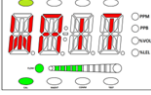
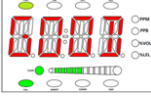
7.6. Span Calibration

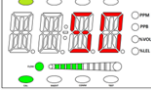
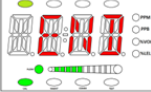
	- When "FUNC" key is pressed for 2 sec or longer in measuring mode, it enters menu selection mode. UP key or DOWN key to select "CALB" (Configuration mode) then press "FUNC" key to turn on CAL LED on bottom left and enter calibration mode.
	- UP key or DOWN key to select "SPAN" (Span Calibration mode) then press "FUNC" key to enter Span configuration mode.
 	- Select whether to proceed to Span Calibration or not. Using "UP key or DOWN key, select "YES" then press "FUNC" key.
	- It is a mode that sets standard gas value when concentration number is flashing. Use UP key or DOWN key to set a value then press "FUNC" key.
 	- Using a calibration tool, inject the standard gas into the sensor at a flow rate of 300 mL/mi for 90 sec. When the measurement is stable after gas injection, press "FUNC" key to automatically run Span calibration and display "WAIT" message.
 	- When the calibration is successful "GOOD" is displayed for 2 sec then it changes to calibration concentration display mode. - When the calibration is unsuccessful "FAIL" is displayed for 2 sec then it changes to calibration concentration display mode.
	- Pressing "FUNC" key in calibration concentration display mode displays "End". Pressing "FUNC" key again returns to "CALB" mode.
	- It means that it has completed setting and changing of the program mode. Pressing "FUNC" key changes to menu mode.

7.7. Alarm Data Setting (Alarm Mode)

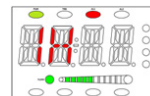
	- When "FUNC" key is pressed for 2 sec or longer in gas concentration display mode at the same time, it enters menu selection mode. - UP key or DOWN key to select "ALAM" (Alarm mode) then press "FUNC" key to alarm setting mode.
	- It is a mode that sets Alarm latch type (Latch). Pressing "FUNC" KEY enters LATCH setting function.
 	- Pressing UP key or DOWN key changes "ON" and "OFF" mode. - When a desired alarm latch type is displayed, press "FUNC" key to set it and enter the next item. - Alarm Latch Type has two modes; "ON" and "OFF". "OFF" mode automatically resets alarm. When "ON", the user must press "RESET" key to release and reset the alarm.
	- It is a mode that sets energizer function of the Trouble/ alarm relay. Pressing "FUNC" key enters alarm relay energizer setting mode.
 	- Pressing UP key or DOWN key changes "ON" and "OFF" mode. - When a desired energizer mode is displayed, press "FUNC" KEY to set it and enter the next item. - Energizer mode has two modes; "ON" and "OFF". When it is in "OFF" mode, relay contact is automatically connected upon an event of trouble/alarm with the relay contact connection turned off. In "ON" mode, the contact connection turns off upon an event of alarm with the relay contact connection on.
	- Alarm1 setting mode message displays "AL-1".
	- It is a mode that sets Alarm1 Level threshold. It can be set in a range of 1~90% of set high scale value. - Pressing UP key or DOWN key increases or decreases Alarm1 threshold, respectively. - When a Alarm1 1 threshold is displayed, press "FUNC" KEY to set it and enter the next item. - Alarm level is set to the concentration outlined in domestic regulations as factory setting.
	- It is a mode to set a direction of Alarm 1 operation. Pressing "UP key or DOWN key displays "1H" or "1L", respectively. - "1H" sets the alarm to run at Alarm1 threshold or higher. "1L" mode runs at Alarm 1 threshold or lower. - When a desired mode is displayed, press "FUNC" KEY to set and enter the next item.

	<ul style="list-style-type: none"> <li>- It is a mode that sets Dead band value for Alarm1 operation. Use "UP key or DOWN key to set a value.</li> <li>- When Alarm 1 is in "1H" mode, Alarm 1 operates at values above the sum of Alarm threshold and dead band values and releases below dead band value subtracted from Alarm threshold.</li> <li>- When Alarm 1 is in "1L" mode, Alarm 1 operation below dead band value subtracted from Alarm threshold and releases above the sum of Alarm1 threshold and dead band value.</li> <li>- When a desired Alarm1 dead band value is displayed, press "FUNC" KEY to set and enter the next item.</li> <li>- This mode is to set a hysteresis value to remove a phenomenon where alarm1 warning runs on/off repeatedly when the gas concentration reaches close to the set alarm1 threshold. Factory default is set to 0.</li> <li>- Ex.) When threshold is 20% LEL/Dead band: 2% LEL, the alarm runs at 22% LEL and is released at 18% LEL with 20% LEL as the reference.</li> </ul>
	<ul style="list-style-type: none"> <li>- Alarm1 setting mode message displays "AL1T".</li> </ul>
	<ul style="list-style-type: none"> <li>- It is a function to prevent instantaneous malfunction of gas detector due to external shock and noise other than from normal operation and time can be set in a range between 0~30 sec.</li> <li>- For Alarm1 dwell time setting, press UP key or DOWN key to increase or decrease in unit of sec, respectively.</li> <li>- When a desired Alarm 1 dwell time is displayed, press "FUNC" KEY to set it and enter the next item.</li> <li>- Ex.) Alarm threshold value: 20% LEL / Delay time: When it is at 5 sec, Alarm triggers when the measured value is above the set value based on 20%LEL for 5 sec or longer. When it goes down below the set value within 5 sec, alarm is not triggered.</li> </ul>
	<ul style="list-style-type: none"> <li>- Alarm1 (Relay) contact output setting mode message displays "A1RL".</li> </ul>
	<ul style="list-style-type: none"> <li>- It is a mode that sets alarm1 contact output. Pressing UP key or DOWN key changes "ON" and "OFF" mode.</li> <li>- When a desired Alarm 1 contact output mode is displayed, press "FUNC" KEY to set it and enter the next item.</li> <li>- Alarm1 contact output mode has two modes: "On" and "Off". In "Of" mode alarm1 contact is not outputted and in "On" mode, it is outputted.</li> </ul>
	<ul style="list-style-type: none"> <li>- Alarm2 setting mode message displays "AL-2".</li> </ul>
	<ul style="list-style-type: none"> <li>- It is a mode that sets Alarm2 Level threshold. It can be set in a range of 1~100% of set high scale value.</li> <li>- Pressing UP key or DOWN key increases or decreases Alarm2 threshold, respectively.</li> <li>- When a desired alarm 2 threshold is displayed, press "FUNC" KEY to set it and enter the next item.</li> <li>- Alarm level is set to the concentration outlined in domestic regulations as factory setting.</li> </ul>
	<ul style="list-style-type: none"> <li>- It is a mode to set a direction of Alarm 2 operation. Pressing "UP key or DOWN key displays "2H" or "2L", respectively.</li> <li>- "2H" sets the alarm to run at Alarm1 threshold or higher. "2L" mode runs at Alarm 2 threshold or lower.</li> <li>- When a desired mode is displayed, press "FUNC" KEY to set and enter the next item.</li> </ul>

	<ul style="list-style-type: none"> <li>- It is a mode that sets Dead band value for Alarm1 operation. Use UP key or DOWN key to set a value.</li> <li>- When Alarm 2 is in "2H" mode, Alarm 2 operates at values above the sum of Alarm and dead band values and releases below the sum.</li> <li>- When Alarm 2 is in "2L" mode, Alarm 2 operation below dead band value subtracted from Alarm threshold and releases above the sum of Alarm threshold and dead band value.</li> <li>- When a desired Alarm2 dead band value is displayed, press "FUNC" KEY to set and enter the next item.</li> <li>- This mode is to set a hysteresis value to remove a phenomenon where alarm2 warning runs ON/off repeatedly when the gas concentration reaches close to the set alarm1 threshold. Factory default is set to 0.</li> <li>- Ex.) When threshold is 20% LEL/Dead band: 2% LEL, the alarm runs at 22% LEL and is released at 18% LEL with 20% LEL as the reference.</li> </ul>
	<ul style="list-style-type: none"> <li>- Alarm2 setting mode message displays "AL2T".</li> </ul>
	<ul style="list-style-type: none"> <li>- It is a function to prevent instantaneous malfunction of gas detector due to external shock and noise other than from normal operation and time can be set in a range between 0~30 sec.</li> <li>- For Alarm2 dwell time setting, press UP key or DOWN key to increase or decrease in unit of 1 sec, respectively.</li> <li>- When a desired Alarm2 dwell time is displayed, press "FUNC" KEY to set it and enter the next item.</li> <li>- Ex.) Alarm threshold value: 20% LEL / Delay time: When it is at 5 sec, Alarm triggers when the measured value is above the set value based on 20%LEL for 5 sec or longer. When it goes down below the set value within 5 sec, alarm is not triggered.</li> </ul>
	<ul style="list-style-type: none"> <li>- Alarm2 (Relay) contact output setting mode message displays "A2RL".</li> </ul>
	<ul style="list-style-type: none"> <li>- It is a mode that sets alarm1 contact output. Pressing UP key or DOWN key changes "ON" and "OFF" mode.</li> <li>- When a desired Alarm2 contact output mode is displayed, press "FUNC" KEY to set it and enter the next item.</li> <li>- Alarm2 contact output mode has two modes: "On" and "Off". In "Off" mode alarm1 contact is not outputted and in "On" mode, it is outputted.</li> </ul>
	<ul style="list-style-type: none"> <li>- It means that it has completed setting and changing of the program mode. Pressing "FUNC" key changes to menu mode.</li> </ul>

### 8.1. Fault List

FAULT	DESCRIPTION & CONDITION	CAUSE
E-10	When a sensor cartridge is not equipped in the main body or it is defective.	1) Sensor cartridge connection fault 2) Sensor Cartridge Unit Fault
E-11	When there is no communication between the main body and sensor cartridge.	1) Sensor Cartridge Unit Fault 2) Main Body Fault
E-12	When there is no gas sensor in Sensor Cartridge.	Sensor cartridge unit fault
E-13	When EEPROM of Sensor PCB is defective.	Sensor Cartridge EEPROM Fault
E-14	When sensor status is defective during self-test.	Fault in gas sensor function built in the sensor cartridge.
E-20	When flow sensor does not run.	Flow sensor fault in Main Unit.
E-21	When flow rate of flow sensor is low.	When flow rate is measured to be below 0%.
E-22	When flow rate of flow sensor is high.	When flow rate is measured to be above 120%.
E-23	When flow rate at flow rate sensor is below the low level (250 ml)	When flow rate is measured to be below the low level (during L-FL on).
E-30	When pyrolyzer current is measured to be below 50mA.	1) Pyrolyzer connection fault 2) Pyrolyzer internal hot-wire fault
E-31	When EEPROM in the main unit is not detected.	EEPROM fault in Main Board.
E-32	When pyrolyzer current is measured to be above 900mA.	Pyrolyzer fault
E-34	When gas measurement is hunting continuously.	1) Check gas sensor measurement status. 2) Check noise input from input power. 3) Sensor cartridge unit fault 4) Main Body Fault

[Table 5. Fault List]

### 8.2. Warning List

WARNING	DESCRIPTION & CONDITION	CAUSE
W-01	When calibration validation has passed.	Exceeded calibration validation period.
W-02	When manufacture data of sensor is not entered.	Sensor Manufacturing Date Error

[Table 6. Warning Code]

### 8.3. Recovery List

NO	CAUSE	SOLUTION
1	Sensor cartridge connection fault	1) Check status of sensor cartridge connector 2) Change sensor cartridge
2	Sensor cartridge unit fault	Change sensor cartridge
3	Gas sensor function failure	Change gas sensor
4	Sensor Cartridge EEPROM Fault	1) Perform Factory Initialization then correct parameter and re-calibrate 2) Change sensor cartridge when the same problem occurs again
5	Flow rate sensor fault	Change main unit
6	When flow rate is measured to be below 0%.	1) Check flow rate at inlet and outlet. 2) Change the main unit if it is not from internal clogging.
7	When flow rate is measured to be above 120%.	Change main unit
8	Pyrolyzer connection fault	1) Check status of pyrolyzer connector 2) Change pyrolyzer if the connector is normal.
9	Pyrolyzer internal hot-wire fault	Change Pyrolyzer
10	EEPROM fault in Main Board.	1) Perform Factory Initialization then correct parameter and re-calibrate 2) Change the main body when the same problem occurs again
11	Pyrolyzer fault	Change Pyrolyzer
12	Main Body Fault	Change main unit
13	Main unit time setting error	1) Reset time 2) Change Backup Battery 3) Change main unit
14	Exceeded calibration validation period.	Re-calibrate sensor or change sensor.
15	Sensor Manufacturing Date Error	Re-calibrate sensor or contact the manufacturer.

[Table 7. Recovery List]

### 9.1. MODBUS RS485

#### 9.1.1. Interface setting

- Data Format: RTU
- Baud rate: 9600 bps
- Data bits: 8bits
- Stop bit: 1bits
- Parity: Even
- For details, please go to [www.modbus.org](http://www.modbus.org)

#### 9.1.2. MODBUS RS485 Address Map

TYPE	ADDRESS	BITS	DESCRIPTION
Integer Gas Measured Value	30001	BIT15~0	Gas measurement value (integer type / decimal point not considered)
Integer High Scale	30002	BIT15~0	High Scale setting value (integer type / decimal point is not considered)
Integer Primary Alarm Setting Value	30003	BIT15~0	Primary alarm setting value (integer type / decimal point is not considered)
Integer Secondary Alarm Setting Value	30004	BIT15~0	Secondary alarm set value (integer type / decimal point is not considered)
Gas detector status value 2	10001	BIT0	Alarm 1
	10002	BIT1	Alarm 2
	10003	BIT2	Fault Bit
	10004	BIT3	MENU Mode (enter Menu)
	10005	BIT4	Test
	10006	BIT5	CAL
	10007	BIT6	Reserved
	10008	BIT7	Toggle Bit (Invert bits in 2 sec intervals)
Test Pattern On	3	BIT0~7	Gas Detector Test Pattern On (GAS Highscale value), Write 0xFF
Normal Restart	2	BIT0~7	Gas Detector Normal Operation restart, Write 0x00

[Table 8. RS485 MODBUS Address Configuration]

### 9.2. MODBUS/TCP Interface

#### 9.2.1. Interface setting

- MODBUS Port Number 502
- For details, please go to [www.modbus.org](http://www.modbus.org)

#### 9.2.2. MODBUS TCP/IP Address Map

TYPE	ADDRESS	BITS	DESCRIPTION
Gas detector State value1	40001	BIT0~3	Monitoring state
			0: Warm up
			1: Measurement Mode
			2: Measurement mode where alarm output is prohibited (check mode)
			3: Reserved
			4: Reserved
			5: Reserved
			6: 4 ~ 20mA Calibration Mode
		7: Flow Calibration Mode	
		8~15: Reserved	
		BIT4	Fault Active State
		BIT5	Reserved
		BIT6	Alarm 1 Active State
		BIT7	Alarm 2 Active State
		BIT8	Alarm1 Relay Active State
		BIT9	Alarm2 Relay Active State
BIT10	Fault Relay Active State		
BIT11	Toggle Bit (Invert bits in 2 sec intervals)		
BIT12	GAS Over State		
BIT13~15	Reserved		
Heart Bit	40002	BIT0~15	1 increments from 0 to 65535 in 1 second increments
Real type gas measurement	40003	BIT0~15	Gas Concentration in floating point format word 1 of 2
	40004	BIT0~15	Gas Concentration in floating point format word 2 of 2
Integer type gas measurement	40005	BIT0~15	Gas Concentration in integer Format (Integer / Decimal Point not considered)
Error Code	40006	BIT0~15	Error Code



TYPE	ADDRESS	BITS	DESCRIPTION
Decimal point and units	40007	BIT0~2	Decimal point indicator
			0: 0 Point
			1: 1 Point
			2: 2 Point
			3: 3 Point
		4~7: Reserved	
		BIT3~7	Reserved
		BIT8~11	Concentration units
			0: Reserved
			1: PPM
			2: PPB
			3: Reserved
			4: % Volume
			5~7: Reserved
			8: % LEL
BIT12~15	Reserved		
Gas detector Temperature measurement	40008	BIT0~15	Temp(Signed 16bit Integer)
Reserved	40009	BIT0~15	Reserved
Reserved	40010	BIT0~15	Reserved
Flow Measures	40011	BIT0~15	Flow Measures
Reserved	40012	BIT0~15	Reserved
Real type primary alarm setting value	40013	BIT0~15	Alarm1 Value in floating point format word 1 of 2
	40014	BIT0~15	Alarm1 Value in floating point format word 2 of 2
Real type 2nd alarm set value	40015	BIT0~15	Alarm2 Value in floating point format word 1 of 2
	40016	BIT0~15	Alarm2 Value in floating point format word 2 of 2
Reserved	40017	BIT0~15	Reserved
Reserved	40018	BIT0~15	Reserved
Gas detector State value 2	40019	BIT0	Alarm1
		BIT1	Alarm2
		BIT2	Fault Bit
		BIT3	MAINTENANCE (Inspection mode)
		BIT4	TEST
		BIT5	CAL
		BIT6	Reserved
		BIT7	Sensor Cartridge Error Bit

TYPE	ADDRESS	BITS	DESCRIPTION
Gas detector State value 2	40019	BIT8	Flow Error Bit
		BIT9	Internal Communication Error
		BIT10	Pyrolyzer Error Bit
		BIT11~15	Reserved
Real High Scale Setting	40020	BIT0~15	High Scale Value in floating point format word 1 of 2
	40021	BIT0~15	High Scale Value in floating point format word 2 of 2
Gas detector status value 2	10001	BIT0	Alarm1
	10002	BIT1	Alarm2
	10003	BIT2	Fault Bit
	10004	BIT3	MENU Mode (Enter Menu)
	10005	BIT4	TEST
	10006	BIT5	CAL
	10007	BIT6	Reserved
	10008	BIT7	Toggle Bit (Invert bits in 2 sec intervals)

[Table 6. MODBUS/ TCP Address Configuration]

### 10.1. GTD-5100F Drawing and Dimensions

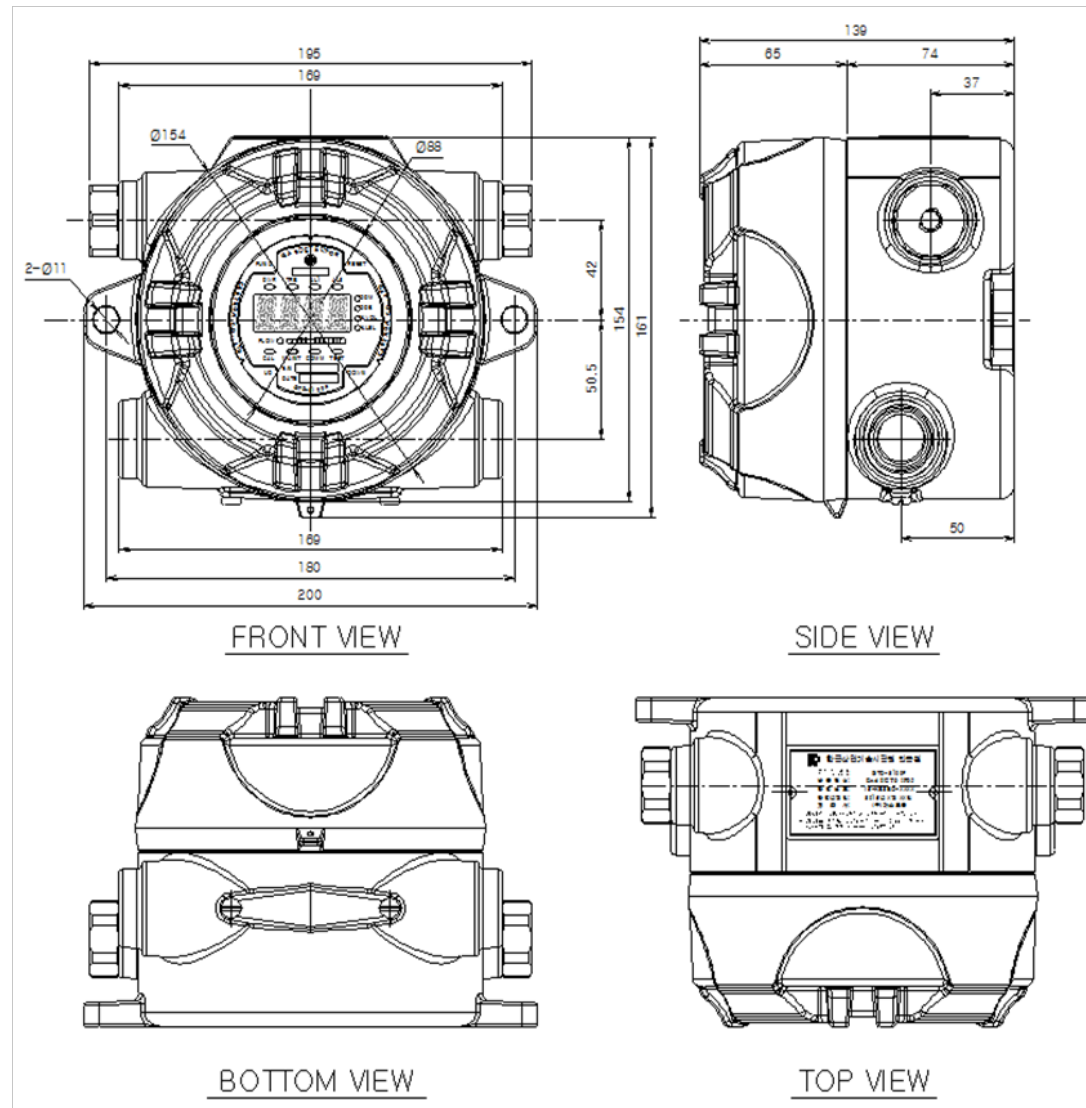

[Figure 7. GTD-5100F Drawing and Dimensions]

### 11.1. Selecting a Place for Installation (Occupational Health & Safety Act Data)

A gas leak detector alarm shall be installed in the following places.

- Around chemical equipment and accessories that have concerns of gas leak. This includes compressors, valves, reactors, pipe joints, etc. installed inside and outside of a building that handle combustible and toxic materials.
- Places that are easier for gases to stay such as areas around manufacturing facilities with ignition sources like heating furnace, etc,
- Areas around equipment for filling combustible and toxic materials.
- Substations, panel rooms, control rooms, and etc. located within explosive area.
- Other areas that are easier for gases to stay.

### 11.2. Selecting a Site for Installation (High-Pressure Gas Safety Control Act Data)

Gas detector of gas leak detector alarm must be installed as close to the areas with concerns of gas leakage as possible. However, for areas where direct gas leakage is not expected but are easier for leaked gas to stay, the detector must be installed at the point 1 of the following.

- Gas leak detector alarm installed outside a building shall be installed at points where gas is likely to stay in consideration to wind direction, wind speed, specific gravity of gas, etc.
- Gas leak detector alarm installed inside a building shall be installed near the floor when the specific gravity of gas is heavier than air and near ventilation of ceiling when it is lighter than air.
- Alarm for gas leak detector alarm must be installed at sites where the gas detector is installed and workers are present.

### 11.3. Precautions during Installation

Avoid areas with electrical barriers such as rain water, etc. It is recommended to be installed in areas that are easier to work in since regular maintenance is needed. Avoid areas with vibration or shock since they can affect output values. Sensor part must be installed towards the direction of gravity.

- This equipment has explosion-proof construction for internal pressure and belongs to GROUP II for gas and vapor in general work sites and chemical plants. It can be used in ZONE 1 (ONE) and ZONE 2 (TWO) hazardous sites.
- Allowable temperature is 85 C or below, which corresponds to T6.
- Use with surrounding temperature in a range of -20 C ~ 60 °C.

- Installation Height: 1,000 M below sea level
- Relative Humidity: 5% ~ 99% (Non-condensing)
- Installation Site: Indoor and Outdoor
- Explosion Ignition Group for Target Gas or Vapor: Ex d IIC T6
- During wiring work, use explosion-proof cable gland at cable inlet or tightly seal cable conduit during metal cable wiring construction to prevent spread of flames in case of explosion or movement of gas, etc. through the cable conduit within 50 mm. All materials including materials used for sealing of unused inlets must have safety certificates!
- When connecting the equipment with cable, screw thread must be tightened 5 threads or more.
- Work in conditions satisfying other [Standards for Selection, Installation, and Maintenance, etc. of Explosion-proof Electric Machine and Equipment Wiring, etc. at Work Site]

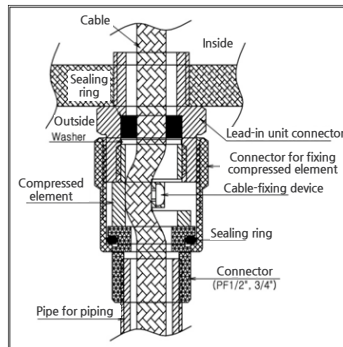

[Figure 8. High-Pressure Packing Type]

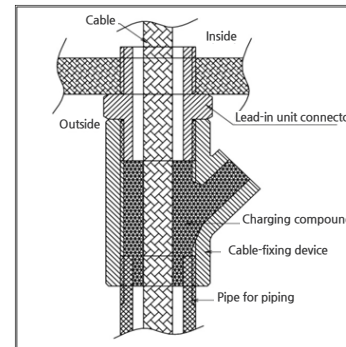

[Figure 9. Y Sealing Compound]

VERSION	CONTENTS	DATE
Rev. 1.0	Initial Revision of Manual	2016.09.29
Rev. 2.0	Changed contents in precautions during Installation	2017.02.02
Rev. 2.1	<ol style="list-style-type: none"> <li>1. Added Address for RS-485</li> <li>2. Corrected Alarm1 setting jumper marking (J5-&gt;J6)</li> <li>3. Corrected Pyrolyzer voltage standard in the Fault List</li> <li>4. Corrected Typo</li> <li>5. Corrected Analog Output Marking Error</li> </ol>	2013.12.11
Rev. 2.2	<ul style="list-style-type: none"> <li>- Corrected Typo</li> <li>- Changed Analog Output Current Value</li> <li>- Inserted Warning Message</li> <li>- Added 3-wire Sink Type</li> </ul>	2017.11.28
Rev. 2.3	<ol style="list-style-type: none"> <li>1. Correct typos and mistyped content</li> <li>2. Modify Modbus Address Map</li> </ol>	