

# DATI 1300

Kennzeichnungsstempel mit Schnellwechselsystem Ø 2,6 – 16 mm  
mit Höhenverstellung, kurzer Typ, zum Einpressen  
*Identification stamp with fast-change system Ø 2,6 – 16 mm with  
height adjustment, short version, for pressing in the mould*

# Kennzeichnungsstempel mit Schnellwechselsystem Ø 2,6 – 16 mm mit Höhenverstellung, kurzer Typ, zum Einpressen

Identification stamp with fast-change system Ø 2,6 – 16 mm with  
height adjustment, short version, for pressing in the mould

## DATI®-BESCHREIBUNG DATI®-DESCRIPTION



- Hülse mit Kennzeichnung
  - Stelleinsatz mit Anzeigepfeil. Der vertiefte Anzeigepfeil dient als Schraub-schlitz zur Einstellung und zum Einsatzwechsel
  - Druckfeder zum stufenlosen Arretieren des Stelleinsatzes
  - Werkstoff für Hülse und Stelleinsatz:  
1.4034 - rostfrei, gehärtet HRC 56 ± 2
  - Beschriftung spiegelbildlich
  - Montage verschraubungsfrei
- Sleeve with identifier
  - Adjustable insert with an indicator arrow. The recessed in-dicator arrow is used as a screw slot for the adjustment and to change the insert
  - Compression spring for the infinite locking of the adjustable insert
  - Material for sleeve and adjustable insert:  
1.4034 - stainless, hardened HRC 56 ± 2
  - Inscription laterally reversed
  - No-screw fitting

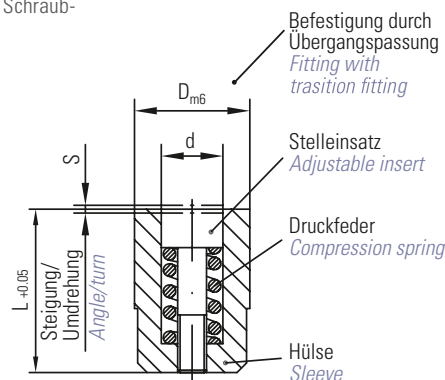

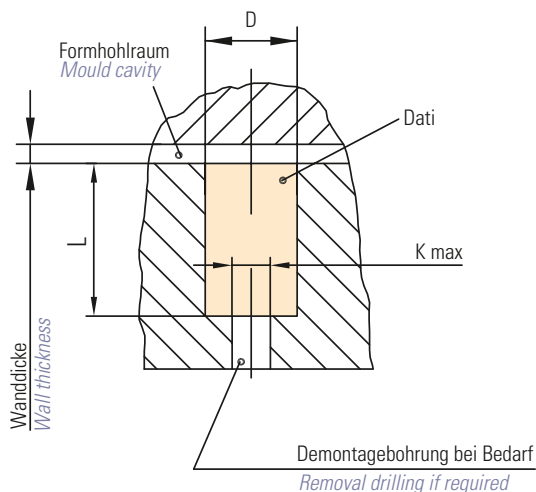
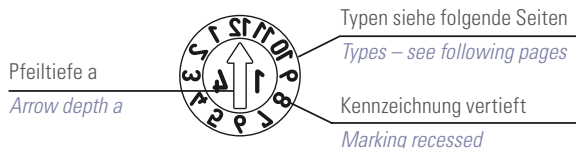

## Montage Installation



Maßtabelle in mm Dimension table in mm					
D	d	L	a	S	K
2,6	1,4	4	0,20	0,20	2,1
2,8	1,4	4	0,20	0,20	2,1
3	1,5	4	0,20	0,20	2,1
3,5	1,8	5	0,20	0,25	2,6
4	2,1	5	0,30	0,25	2,6
5	3,1	8	0,40	0,20	3,2
6	3,1	8	0,40	0,20	3,2
8	4,4	10	0,40	0,25	5,2
10	5,2	12	0,40	0,35	6,2
12	6,2	14	0,60	0,35	7,2
16	8,2	14	0,60	0,35	8,2

## SNELLWECHSELSYSTEM FAST CHANGING SYSTEM

			Der Stelleinsatz mit Jahreszahl wird zum Jahreswechsel durch Aus- und Eindrehen in Sekunden-schnelle gewechselt. - Fertigung unterbrechen, Form öffnen - Stelleinsatz wechseln, Zeitraum einstellen - Fertigung fortsetzen - Kontrolle der Einstellung am Spritzteil  <i>At the end of each year, the adjustable insert with year is changed in a matter of seconds by removing and screwing it in.</i> - Stop production, open mould - Change adjustable insert, set date - Continue production - Check setting on moulded part
<b>Stelleinsatz eindrehen:</b> <ul style="list-style-type: none"> <li>• Rechts drehen</li> <li>• Nach Augenmaß auf Höhe einstellen</li> </ul> <p><i>To screw in adjustable insert:</i></p> <ul style="list-style-type: none"> <li>• Turn clockwise</li> <li>• Adjust height according to visual estimate</li> </ul>	<b>Stelleinsatz verdrehen:</b> <ul style="list-style-type: none"> <li>• Rechts oder links einstellen</li> <li>• Auf Höhenverstellung achten</li> </ul> <p><i>To turn adjustable insert:</i></p> <ul style="list-style-type: none"> <li>• Turn clockwise or counter-clockwise</li> <li>• Check height adjustment</li> </ul>	<b>Stelleinsatz wechseln:</b> <ul style="list-style-type: none"> <li>• Kontinuierlich nach links drehen</li> <li>• Stelleinsatz hebt sich</li> <li>• Stelleinsatz entnehmen</li> </ul> <p><i>To change adjustable insert:</i></p> <ul style="list-style-type: none"> <li>• Turn continuously counter-clockwise</li> <li>• The adjustable insert will raise</li> <li>• Remove adjustable insert</li> </ul>	

# DATI 1300

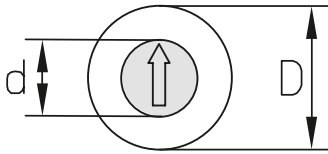

Maßtabelle in mm Dimension table in mm

D	2,6	2,8	3	3,5	4	5	6	8	10	12	16	mm
d	1,4	1,4	1,5	1,8	2,1	3,1	3,1	4,4	5,2	6,2	8,2	mm
L	4	4	4	5	5	8	8	10	12	14	14	mm
M	ohne Gewinde <i>without tread</i>											

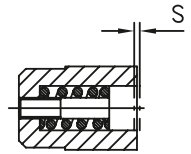





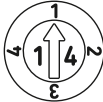

Typ Type	A		B		C		CC	
Anzeige Indicator	Monate + Jahr (z. B. Dez. 14) <i>Months + year</i> (e.g. dec. 14)		Monate (z. B. Dez.) kombinierbar mit Typ C (zeigt z. B. Dez. 14) <i>Months (e.g. dec.) connected with</i> <i>type C (displays e.g. dec. 14)</i>		Jahr + 5 Jahre kombinierbar mit Typ B (zeigt z. B. Dez. 14) <i>Year + 5 years connected with type B</i> (displays e.g. dec. 14)		Jahr + 11 Jahre kombinierbar mit Typ B (zeigt z. B. Dez. 14) <i>Year + 11 years connected with</i> <i>type B (displays e.g. dec. 14)</i>	
D	Bestell-Nr. <i>Order no.</i>	Euro	Bestell-Nr. <i>Order no.</i>	Euro	Bestell-Nr. <i>Order no.</i>	Euro	Bestell-Nr. <i>Order no.</i>	Euro
2,6	A/1302,6/Jahr(Year)		B/1302,6/00		C/1302,6/Jahr(Year)+5		CC/1302,6/Jahr(Year)+11	
2,8	A/1302,8/Jahr(Year)		B/1302,8/00		C/1302,8/Jahr(Year)+5		CC/1302,8/Jahr(Year)+11	
3	A/1303/Jahr(Year)		B/1303/00		C/1303/Jahr(Year)+5		CC/1303/Jahr(Year)+11	
3,5	A/1303,5/Jahr(Year)		B/1303,5/00		C/1303,5/Jahr(Year)+5		CC/1303,5/Jahr(Year)+11	
4	A/1304/Jahr(Year)		B/1304/00		C/1304/Jahr(Year)+5		CC/1304/Jahr(Year)+11	
5	A/1305/Jahr(Year)		B/1305/00		C/1305/Jahr(Year)+5		CC/1305/Jahr(Year)+11	
6	A/1306/Jahr(Year)		B/1306/00		C/1306/Jahr(Year)+5		CC/1306/Jahr(Year)+11	
8	A/1308/Jahr(Year)		B/1308/00		C/1308/Jahr(Year)+5		CC/1308/Jahr(Year)+11	
10	A/1310/Jahr(Year)		B/1310/00		C/1310/Jahr(Year)+5		CC/1310/Jahr(Year)+11	
12	A/1312/Jahr(Year)		B/1312/00		C/1312/Jahr(Year)+5		CC/1312/Jahr(Year)+11	
16	A/1316/Jahr(Year)		B/1316/00		C/1316/Jahr(Year)+5		CC/1316/Jahr(Year)+11	

Typ Type	D + E		H + I		L + E		J	
Anzeige Indicator	Woche + Jahr (z. B. ergeben die Kombizahlen 30 + 5: Kw 35/14) <i>Week + year</i> (e.g. add up to combination numbers 30 + 5: calendar week 35/14)		Tage (z. B. 20 + 9 = 29) kombinierbar mit Typ A (zeigt z. B. 29. Dez. 14) <i>Days</i> (e.g. 20 + 9 = 29) connected with type A (displays e.g. 29. dec. 14)		Tage + Monate + Jahr (z. B. 25. Mai 14) <i>Days + month + year</i> (e.g. 25. may 14)		Schichtzahlen (z. B. 2. Schicht) <i>Shift numbers</i> (e.g. 2nd shift)	
D	Bestell-Nr. <i>Order no.</i>	Euro	Bestell-Nr. <i>Order no.</i>	Euro	Bestell-Nr. <i>Order no.</i>	Euro	Bestell-Nr. <i>Order no.</i>	Euro
2,6	D+E/1302,6/Jahr(Year)		H+I/1302,6/00		L+E/1302,6/Jahr(Year)		J/1302,6/00	
2,8	D+E/1302,8/Jahr(Year)		H+I/1302,8/00		L+E/1302,8/Jahr(Year)		J/1302,8/00	
3	D+E/1303/Jahr(Year)		H+I/1303/00		L+E/1303/Jahr(Year)		J/1303/00	
3,5	D+E/1303,5/Jahr(Year)		H+I/1303,5/00		L+E/1303,5/Jahr(Year)		J/1303,5/00	
4	D+E/1304/Jahr(Year)		H+I/1304/00		L+E/1304/Jahr(Year)		J/1304/00	
5	D+E/1305/Jahr(Year)		H+I/1305/00		L+E/1305/Jahr(Year)		J/1305/00	
6	D+E/1306/Jahr(Year)		H+I/1306/00		L+E/1306/Jahr(Year)		J/1306/00	
8	D+E/1308/Jahr(Year)		H+I/1308/00		L+E/1308/Jahr(Year)		J/1308/00	
10	D+E/1310/Jahr(Year)		H+I/1310/00		L+E/1310/Jahr(Year)		J/1310/00	
12	D+E/1312/Jahr(Year)		H+I/1312/00		L+E/1312/Jahr(Year)		J/1312/00	
16	D+E/1316/Jahr(Year)		H+I/1316/00		L+E/1316/Jahr(Year)		J/1316/00	

# Kennzeichnungsstempel mit Schnellwechselsystem Ø 2,6 – 16 mm mit Höhenverstellung, kurzer Typ, zum Einpressen

Identification stamp with fast-change system Ø 2,6 – 16 mm with  
height adjustment, short version, for pressing in the mould

Typ Type	K		M		N		R	
								
Anzeige Indicator	Quartal + Jahr (z. B. 1. Quartal 14)  <i>Quarter + year (e.g. 1. quarter 14)</i>		Kennbuchstaben A – M (Typ M)  <i>Identifier letters A – M (type M)</i>		Kennbuchstaben N – Z (Typ N)  <i>Identifier letters N – Z (type N)</i>		Kennzeichnung nach Wunsch z. B. Materialkennzeichnung  <i>Identification according to customers preference e.g. material identification</i>	
D	Bestell-Nr. Order no.	Euro	Bestell-Nr. Order no.	Euro	Bestell-Nr. Order no.	Euro	Bestell-Nr. Order no.	Euro
2,6	K/1302,6/Jahr(Year)		M/1302,6/00		N/1302,6/00		R/1302,6/Zeichen(Symbol)	
2,8	K/1302,8/Jahr(Year)		M/1302,8/00		N/1302,8/00		R/1302,8/Zeichen(Symbol)	
3	K/1303/Jahr(Year)		M/1303/00		N/1303/00		R/1303/Zeichen(Symbol)	
3,5	K/1303,5/Jahr(Year)		M/1303,5/00		N/1303,5/00		R/1303,5/Zeichen(Symbol)	
4	K/1304/Jahr(Year)		M/1304/00		N/1304/00		R/1304/Zeichen(Symbol)	
5	K/1305/Jahr(Year)		M/1305/00		N/1305/00		R/1305/Zeichen(Symbol)	
6	K/1306/Jahr(Year)		M/1306/00		N/1306/00		R/1306/Zeichen(Symbol)	
8	K/1308/Jahr(Year)		M/1308/00		N/1308/00		R/1308/Zeichen(Symbol)	
10	K/1310/Jahr(Year)		M/1310/00		N/1310/00		R/1310/Zeichen(Symbol)	
12	K/1312/Jahr(Year)		M/1312/00		N/1312/00		R/1312/Zeichen(Symbol)	
16	K/1316/Jahr(Year)		M/1316/00		N/1316/00		R/1316/Zeichen(Symbol)	

Typ Type	T		WT		Z	
						
Anzeige Indicator	Tage 1 – 31 <i>Days 1 – 31</i>		Wochentage 1 – 7 <i>Weekdays 1 – 7</i>		ohne Kennzeichnung <i>without markings</i>	
D	Bestell-Nr. Order no.	Euro	Bestell-Nr. Order no.	Euro	Bestell-Nr. Order no.	Euro
2,6	—		WT/1302,6/00		Z/1302,6/00	
2,8	—		WT/1302,8/00		Z/1302,8/00	
3	—		WT/1303/00		Z/1303/00	
3,5	T/1303,5/00		WT/1303,5/00		Z/1303,5/00	
4	T/1304/00		WT/1304/00		Z/1304/00	
5	T/1305/00		WT/1305/00		Z/1305/00	
6	T/1306/00		WT/1306/00		Z/1306/00	
8	T/1308/00		WT/1308/00		Z/1308/00	
10	T/1310/00		WT/1310/00		Z/1310/00	
12	T/1312/00		WT/1312/00		Z/1312/00	
16	T/1316/00		WT/1316/00		Z/1316/00	

Stelleinsätze passend zu  
 DATI 1300 / 1400 / 1800  
 Adjustable inserts for DATI 1300 / 1400 / 1800

# DATI 1300

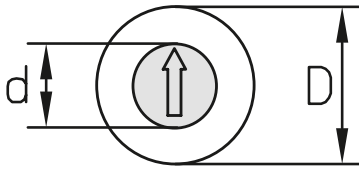

Stelleinsätze werden auf Wunsch mit Druckfeder geliefert!  
 Adjustable insert will be delivered with compression spring on request!

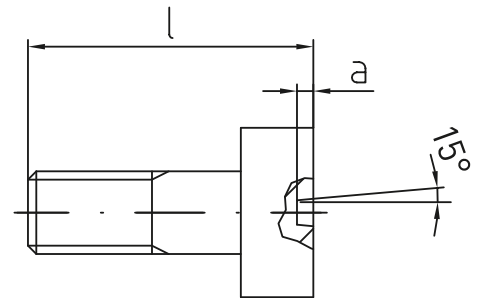

Maßstabelle in mm Dimension table in mm												
D	2,6	2,8	3	3,5	4	5	6	8	10	12	16	mm
d	1,4	1,4	1,5	1,8	2,1	3,1	3,1	4,4	5,2	6,2	8,2	mm
L	3,8	3,8	3,8	4,8	4,8	7,8	7,8	9,8	11,8	13,8	13,8	mm
a	0,2	0,2	0,2	0,2	0,3	0,4	0,4	0,4	0,4	0,6	0,6	mm

Werkstoff:  
 1.4034, gehärtet HRC 56 ± 2 rostfrei

Material:  
 1.4034, hardened HRC 56 ± 2 stainless

## Stelleinsätze für DATI 1300 Adjustable inserts for DATI 1300

Typ Type	F		G		O	
Anzeige Indicator	Stelleinsatz mit Pfeil + Jahr <i>Adjustable inserts with arrow + year</i>		Stelleinsatz mit Pfeil ohne Jahr <i>Adjustable inserts with an arrow without year</i>		Stelleinsatz nach Kundenwunsch mit Zahlen und /oder Buchstaben <i>Adjustable inserts according to customer preference with numbers and /or letters</i>	
D	Bestell-Nr. Order no.	Euro	Bestell-Nr. Order no.	Euro	Bestell-Nr. Order no.	Euro
2,6	F/1302,6/Jahr(Year)		G/1302,6/00		O/1302,6/Zeichen(Symbol)	
2,8	F/1302,8/Jahr(Year)		G/1302,8/00		O/1302,8/Zeichen(Symbol)	
3	F/1303/Jahr(Year)		G/1303/00		O/1303/Zeichen(Symbol)	
3,5	F/1303,5/Jahr(Year)		G/1303,5/00		O/1303,5/Zeichen(Symbol)	
4	F/1304/Jahr(Year)		G/1304/00		O/1304/Zeichen(Symbol)	
5	F/1305/Jahr(Year)		G/1305/00		O/1305/Zeichen(Symbol)	
6	F/1306/Jahr(Year)		G/1306/00		O/1306/Zeichen(Symbol)	
8	F/1308/Jahr(Year)		G/1308/00		O/1308/Zeichen(Symbol)	
10	F/1310/Jahr(Year)		G/1310/00		O/1310/Zeichen(Symbol)	
12	F/1312/Jahr(Year)		G/1312/00		O/1312/Zeichen(Symbol)	
16	F/1316/Jahr(Year)		G/1316/00		O/1316/Zeichen(Symbol)	

