

3171MR & 3171S

Weatherproof Vibration Switches



The type 3171 vibration switch is a low-cost, vibration-sensitive switch for the protection of rotating and reciprocating machinery. It is adjustable to operate above the machine's normal running levels of vibration, activating machine shut-down circuits and/or alarms. Once operated the internal micro switch remains latched until reset.

The type 3171 vibration switch, with its low frequency response is ideal for detection of mass imbalance on most machines. It is inherently insensitive to high frequency components and those caused by external knocks, etc. The 3171 vibration switch is responsive to vibrations in all directions.

The type 3171 vibration switch is reset by depressing a button on the bottom face (see diagram below) and for the 3171S model, also by temporarily energising an internal solenoid.

Adjustment of the vibration trip level is made externally at the top of the unit by rotating a sealed control.

A single pole vibration switch uses one internal micro switch for switching off machinery when an increase in peak acceleration is detected. A double pole vibration switch has an additional internal micro switch which operates simultaneously with the first one. Two micro switches give the use of redundancy for increased safety and can also be used for monitoring the state of the vibration switch.

Compliance and Standards



Compliance:

Machinery Directive 2006/42/EC, EMC Directive 2004/108/EC, RoHS Directive 2002/95/EC, REACH Directive 1907/2006/EC

Standards:

Safety - BS EN 60204-1:2006+A1:2009
Switching and Durability to Low-voltage switchgear and controlgear - BS EN 60947-1:2007 and BS EN 60947-5-1:2004+A1:2009
EMC - BS EN55011 and BS EN61000-4
Salt mist - BS EN 60068-2-52:1996 test Kb severity 2

Ingress protection rating:

IP66/IP67 to BS EN 60529

Features

- Ease of installation on new or existing plant and machinery
- Robust for industrial environments
- Manual or remote electrical reset
- SPCO or DPCO (manual reset) or DPST (with remote reset)
- Must be vertically mounted as in diagram below - sensitive in horizontal, lateral and vertical planes
- Electrical connections via M20x1.5mm cable entry (Models can be adapted for two cable entries)
- Maintenance free operation
- Models for operation in hazardous areas, see appropriate data sheet
- Captive lid and fasteners
- Two year warranty (from date of Invoice)
- Accessories available - visit www.ffeuk.com for further details
- Blanking plug accessory for corrosion protection when mounted into the field un-wired

Applications

The 3171 is ideal for use on rotating and reciprocating machinery (below 3000rpm) such as fans, centrifuges, compressors, pumps, turbines, motors and generators, vibrating conveyors, vertical and horizontal crushers and shakers.



Dimensions (mm)

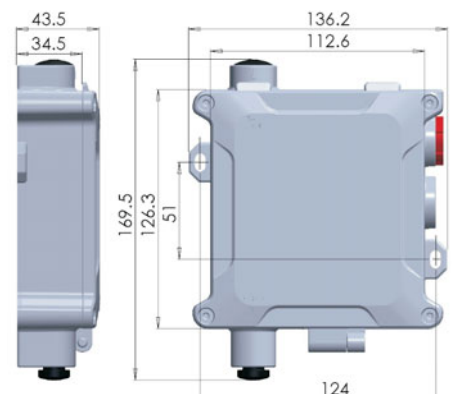

3171MR & 3171S

Specification

3171MR Electro-mechanical vibration switch with manual reset

Drop and free fall:	BS EN60079-0 section 26.4
Performance:	Set level range 0.5 to 9g peak acceleration
Rated operating voltage:	AC 250 V 50/60 Hz
Utilisation category:	AC-15 3A 250Vac, DC-13 0.15A 250Vdc, DC-13 3A 30Vdc
Switch rating:	Resistive load - AC 5A 250V, DC 5A, 30V
Enclosure material:	Die-cast zinc alloy Mazak III
Enclosure finish:	Iron passivation with goose grey polyester powder coat
Temperature range:	-45 to +85°C
Weight:	1.5kg typical
Connections:	Internal terminal block via M20x1.5mm threaded cable entry
Mounting:	Mount vertically with reset button at bottom using fixings size M5 and anti-vibration washers or similar.
Contact Arrangements:	SPCO or DPCO

3171S Electro-mechanical vibration switch with remote reset (as above unless stated)





Contact Arrangement:	DP ST NC+NO
Remote reset	Mains solenoids continuously rated for 115V a.c. or 240V a.c.
solenoid options:	24-28V DC solenoid rated for intermittent use with 25% duty e.g. 30s on and 90s off

Options

Alternative switch contacts:	Gold-plated contacts for low energy switching and/or monitoring. Rating 0.1A 125V AC
Second cable entry:	3171 can be supplied with a second M20x1.5mm threaded cable entry
Pre-sets:	Where the rotating machine has a dominant frequency at 25Hz, Fire Fighting Enterprises can provide a pre-set switch between 1g & 9g

Order Code

(For example: 8001-030)

8			- 0			
Type:		Contacts		Poles:	Reset:	Pre-Set:
0 - Weatherproof		Material:		0 - Single Pole	0 - Manual Reset	0 - Factory Set
1 - ATEX		0 - Silver		1 - Double	1 - DC Solenoid Reset (24-28V)	1 - Preset*
		1 - Gold			2 - 115VAC Solenoid Reset	2 - Second Cable Entry (Factory Set)*
					3 - 240VAC Solenoid Reset	3 - Second Cable Entry (Preset)*
						* See Options above



Electrical Arrangements

Double-Throw (Change-Over):
(for manual reset)

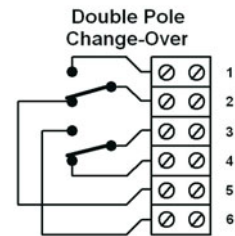
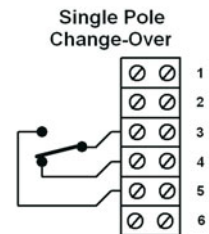

Single-Throw (On-Off):
(for remote reset)

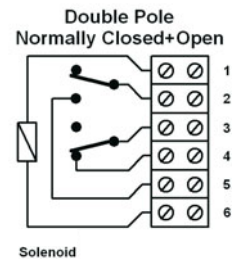

Switches are shown in their normal system operating position after a manual or remote reset has been performed