

Positive displacement flowmeter/ threshold detector



- Indication, monitoring, transmitting and On/Off control in one device
- Selectable outputs (transistor or relay)
- Automatic calibration: Teach-In
- Process value output: 4...20 mA

Type SE32 + S077 can be combined with...



Type 8802-YG-I

(2300 + 8692)
ELEMENT Control valve



Type 8619

multiCELL
transmitter/controller



Type 8792

Positioner
SideControl

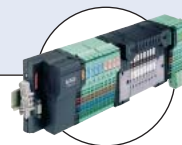

Type 8644-P AirLINE

Valve island with
electronic I/O

This positive displacement flowmeter/threshold detector with display is designed for use in highly viscous fluid like glue, honey or oil and specially to switch a valve and to establish a monitoring system or an On/Off control loop. The switching points can be configured with the 3-keys below the display.

The flowmeter is available with On/Off output, or with process value outputs.

General data	
Compatibility	With sensor fittings S077 (see corresponding data sheet)
Materials	Housing, cover / Front panel folio PC, glass fibre reinforced / Polyester Screws / Cable plug, connector M12 Stainless steel / PA Wetted parts materials Sensor fitting body Aluminium or stainless steel (316L) Rotor PPS, aluminium or stainless steel (316L) Shaft / Seal Stainless steel (316L) / FKM or FEP/PTFE encapsulated
Display	8-digit LCD with backlighting
Electrical connections	Cable plug acc. to EN 175301-803 Free positionable male M12 connector, 5 pins or male M12 connector, 8 pins
Voltage supply cable	0.5 mm ² max. cross section; max. 100 m length, shielded
Complete device data (sensor fitting S077 + electronic module SE32)	
Pipe diameter	DN15...DN100
Thread connection	1/2"; 1"; 1 1/2"; 2"; 3" (G or NPT)
Flange connection	25; 40; 50; 80 or 100 mm DIN PN16 flange 1"; 1 1/2"; 2"; 3" or 4" ANSI 150LB flange
Measuring range	
Viscosity > 5 mPa.s	2...1200 l/min (0.53...320 gpm)
Viscosity < 5 mPa.s	3...616 l/min (0.78...320 gpm)
Medium temperature with body in aluminium / in stainless steel	-20...+80°C (-4...+176°F) / -20...+120°C (-4...+248°F)
Fluid pressure max.	
DN15	55 bar (798.05 PSI) (threaded process connection)
DN25 / DN40 or DN50	55 bar (798.05 PSI) ¹⁾ / 18 bar (261.18 PSI)
DN80 / DN100	12 bar (174.12 PSI) / 10 bar (145.1 PSI)
Viscosity	1 Pa.s max. (higher on request)
Measurement deviation	±1% of Reading (if "standard" K-factor is used) ±0.5% of Reading (if "specific" K-factor is used, on label of the product)
Repeatability	±0.03% of Reading

¹⁾ or in accordance to the value of the used flanges

Electrical data	
Operating voltage	12...36 V DC ±10%, filtered and regulated
Reversed polarity of DC	Protected
Current consumption	≤ 90 mA (without load)
Outputs	
Transistor	NPN and/or PNP (selectable), open collector, max. 700 mA, 500 mA max. per transistor if both transistor outputs are wired, 0...300 Hz NPN-output: 0.2...36 V DC PNP-output: Power supply protected against short circuit.
Relay	3 A/250 V AC or 3 A/30 V DC; [3 A/48 V AC or 3 A/30 V DC] ² .
Process value	4...20 mA, galvanic insulation Loop resistance: 1300 Ω at 36 V DC, 1000 Ω at 30 V DC, 700 Ω at 24 V DC, 450 Ω at 18 V DC, 200 Ω at 12 V DC
Environment	
Ambient temperature	0...+60°C (+14°F...+140°F) (operating and storage)
Relative humidity	≤ 80%, without condensation
Standards, directives and approvals	
Protection class	IP65 with connector mounted and tightened correctly
Standard, directives	
EMC	EN 610006-2, 610006-3
Safety	EN 61010-1
Pressure (Sensor fitting S077, DN15... DN100, in aluminium or stainless steel)	Complying with article 3 of Chap. 3 from 97/23/CE directive.* (without CE mark)
Vibration / Shock	EN 60068-2-6 / EN 60068-2-27
Approvals	
UL-Recognized for US and Canada 	UL61010-1 + CAN/CSA-C22.2 No.61010-1

Specific technical data of UL-recognized products for US and Canada

Ambient temperature	0...+40°C (32°F...104°F)
Height above sea level	max. 2000 m
Intended for an inner pollution	Pollution degree 2
Installation category	Category I

²⁾ if 4...20 mA and relay

* For the 97/23/CE pressure directive, the device can only be used under following conditions (dependent on max. pressure, pipe diameter and fluid).

Type of fluid	Conditions
Fluid group 1, chap. 1.3.a	Forbidden
Fluid group 2, chap. 1.3.a	DN ≤ 32 or PN*DN ≤ 1000
Fluid group 1, chap. 1.3.b	PN*DN ≤ 2000
Fluid group 2, chap. 1.3.b	DN ≤ 200

Design and principle of operation

The flowmeter/threshold detector is built up with an electronic module SE32 associated to a sensor fitting S077 with integrated measurement oval rotor. This connection is made by means of a Quarter-Turn.

The output signal is provided via cable plug according to EN 175301-803 and/or a M12 multipin connector.

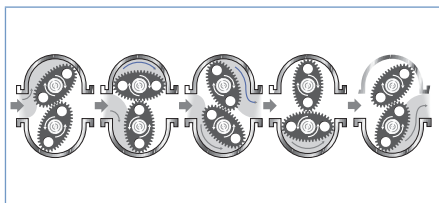
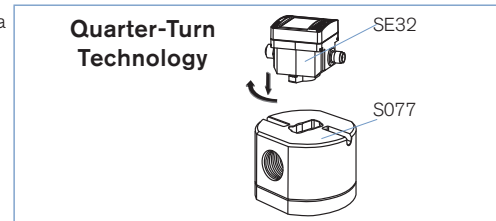

When liquid flows through the pipe, the rotors turn. This rotation produces a measuring signal in the associated hall sensor. The frequency and amplitude are proportional to the flow. The volume of the fluid being transferred in this way is exactly determined through the sensor geometry. A conversion coefficient, specific to each meter size, enables the conversion of this frequency into a flow rate. The standard K-factor depending on the meter size is available in the instruction manual of the sensor fitting S077, or to improve the measurement deviation, a specific K-factor is given with each device on its label.

Installation

The sensor fitting can be installed in any orientation as long as **the rotor shafts are always in a horizontal plane** (see figures to the right).

The pipe must be filled with liquid and free from air bubbles. Avoid air purge of the system which would cause damages and to prevent damage from dirt or foreign matter, we strongly recommend the installation of a 250 µm strainer as close as possible to the inlet side of the meter.

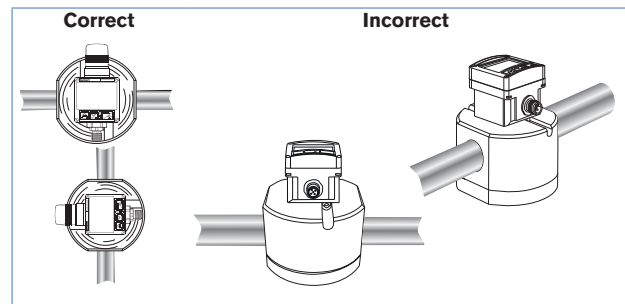

Operation and display

The device can be calibrated by means of the K-factor, or via the Teach-In function. User adjustments, such as engineering units, output, filter, bargraph are carried out on site.

▶ Indication in operating mode/Display

- measured flow
- high threshold value
- low threshold value

▶ Parameter definition

- engineering units (International measuring units)
- K-factor/Teach-In function
- selection of switching mode (window, hysteresis) (see main features)
- selection of threshold value (see main features)
- delay
- filter
- 10-segment bargraph (select min. and max. value)
- Password protects the access to the menu

▶ Test

- switching threshold test with flow simulation
- Calibration of the 4...20 mA current output

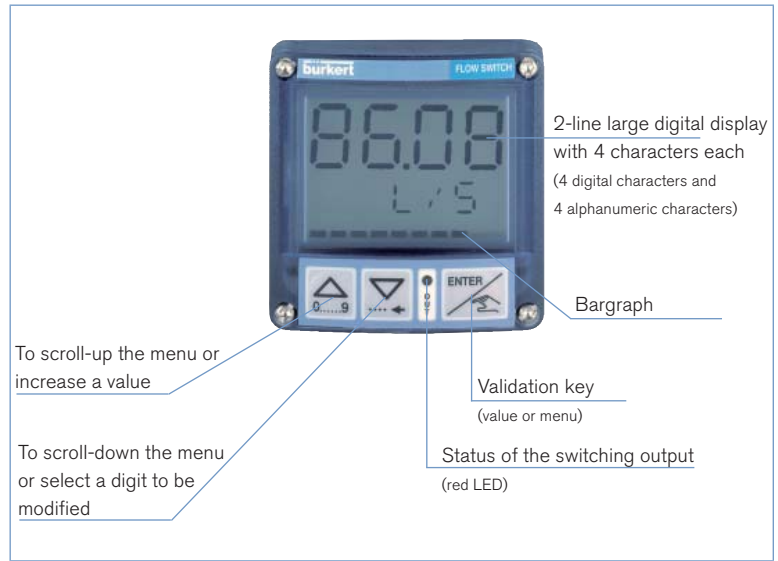

Main features

SE32 with standard On/Off output

- 2 switching modes for the output, either hysteresis or window, inverted or not

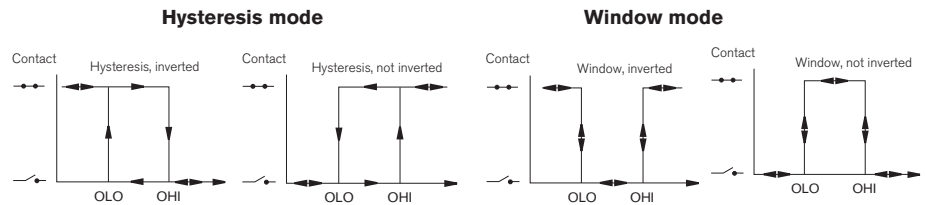

- Configurable delay before switching
- Possible outputs depending on the version: relay, transistor NPN, transistor PNP

SE32 with current output for the measurement value

- 4...20 mA output
- 4...20 mA output + relay output

Dimensions

Electronics SE32

Orifice	H
15	71
25	80
40	92
50	102
80	152
100	168

DN15 DN25 DN40 DN50 DN80
Threaded connection
DN25 DN40 DN50 DN80 DN100
Flanged connection

Ordering chart for complete flowmeter/threshold detector Type SE32 + S077

A complete flowmeter/threshold detector consists of:

- an electronic module Type SE32
- an INLINE sensor fitting Type S077 (DN15..DN100 - Refer to corresponding data sheet)

Electronic module Type SE32 - for sensor fitting Type S077 (to be ordered separately)

Operating voltage	Outputs	Agreements	Electrical connection	Item no.
12...36 V DC	NPN	-	Cable plug EN 175301-803*	436 474
	PNP	-	Cable plug EN 175301-803*	434 871
	NPN and PNP	-	Free positionable male M12 connector, 5 pins	436 473
		UL-Recognized for US and Canada 	Free positionable male M12 connector, 5 pins	553 431
	Relay	-	Free positionable male M12 connector, 5 pins and cable plug EN 175301-803*	436 475
	4...20 mA + relay	-	Male M12 connector, 8 pins and cable plug EN 175301-803*	560 547
	4...20 mA + relay	-	Free positionable male M12 connector, 5 pins and cable plug EN 175301-803	560 402
	4...20 mA	-	Free positionable male M12 connector, 5 pins	560 403

* Europe/Asia (G/Rc): M16 x 1.5 mm cable plug USA/CDN (NPT): NPT1/2" cable plug

Ordering chart for accessories (to be ordered separately)

Description	Item no.
Female M12 connector, 5 pins, with plastic threaded locking ring	917 116
Female M12 connector, 5 pins, moulded on cable (2 m, shielded)	438 680
Female M12 connector, 8 pins, with plastic threaded locking ring	444 799
Female M12 connector, 8 pins, moulded on cable (2 m, shielded)	444 800
Cable plug EN 175301-803 with cable gland (Type 2508)	438 811
Cable plug EN 175301-803 with NPT1/2" reduction without cable gland (Type 2509)	162 673

Interconnection possibilities with other Bürkert products



Type 8802-GD-J -
(2301 + 8693)
ELEMENT Control valve
4 ... 20 mA output

Type 6212 -
Solenoid valve
Transistor output

Relay output

Type SE32 + S077-
Flowmeter/threshold detector
More info.