

PNEUMATIC ROTARY ACTUATORS

AP SERIES

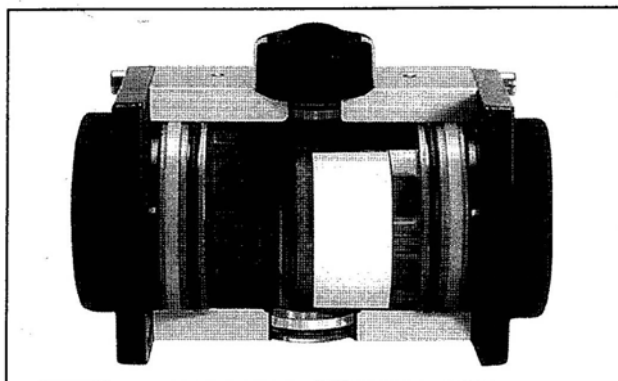

MOVIMENTO PISTONI IN APERTURA - COUNTER CLOCKWISE OUTPUT ROTATION

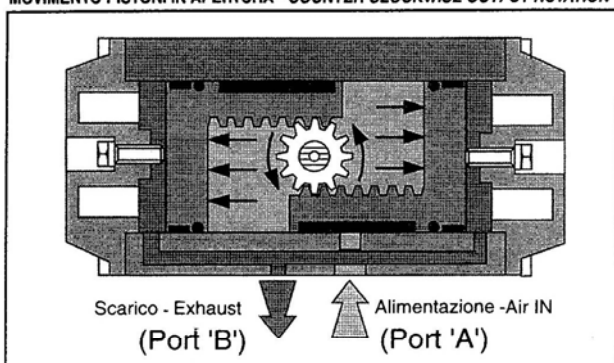

**ATTUATORI A DOPPIO EFFETTO (DA) ISO 5211
DOUBLE ACTING ACTUATOR (DA) ISO 5211**

PRINCIPIO DI FUNZIONAMENTO - PRINCIPLE OF OPERATION

Immettendo pressione nel Port 'A', si ottiene il riempimento della camera centrale del cilindro, e di conseguenza lo spostamento dei pistoni verso l'esterno, favorendo, tramite i due registri meccanici, montati sulle due testate, la regolazione della corsa. Nello stesso momento, l'aria all'interno delle due camere laterali viene scaricata attraverso il Port 'B'. Di seguito, immettendo pressione nel Port 'B', si ottiene il riempimento delle due camere laterali, tramite un piccolo condotto ricavato lungo il corpo del cilindro, e di conseguenza lo spostamento dei pistoni verso l'interno scaricando l'aria esistente all'interno della camera centrale, attraverso il Port 'A'.

Counter clockwise output operation is achieved by inserting pressure into Port 'A', to force the pistons apart thus rotating the actuator pinion counter clockwise. During the operation, air from the outer chambers is exhausted through Port 'B'. Clockwise output operation is achieved by reverse of the above and inserting pressure into Port 'B'.

MOVIMENTO PISTONI IN CHIUSURA - CLOCKWISE OUTPUT ROTATION

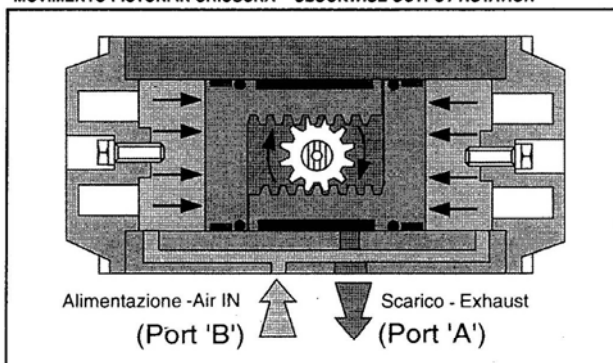

ELEMENTI NECESSARI PER IL DIMENSIONAMENTO DEGLI ATTUATORI - DATA REQUIRED FOR ACTUATOR SIZING

- 1) Conoscere l'effettiva coppia della valvola o di altra apparecchiatura da automatizzare, considerando un coefficiente di sicurezza (SIRCA raccomanda minimo 25%).
Valve torque (min. 25% safety recommended).
- 2) Decidere se il comando deve essere a doppio effetto o con molla di ritorno. - *Double acting or spring return operation.*
- 3) Conoscere l'effettiva pressione d'aria disponibile all'utilizzo. - *Minimum available operating pressure.*

COME DIMENSIONARE GLI ATTUATORI A DOPPIO EFFETTO (DA) - SELECTION OF DOUBLE ACTING ACTUATORS (DA)

Il dimensionamento degli attuatori a doppio effetto è molto semplice. E' necessario conoscere la "coppia richiesta" della valvola (maggiorata min. del 25% per coefficiente di sicurezza) e la pressione dell'aria disponibile, dopodiché, congiungere i due riferimenti e immediatamente si ricava il modello dell'attuatore corrispondente. **ESEMPIO:** dovendo automatizzare una valvola che richiede una coppia di 80Nm aumentata del 25% = 100Nm a 5 bar d'aria di alimentazione, la scelta cade sul modello AP4DA che sviluppa una coppia di 119 Nm. **ATTENZIONE:** il valore di coppia scelto, che determina il modello dell'attuatore, non deve essere mai inferiore al valore di "coppia richiesta" della valvola. *Determine the required valve torque, this should include 25% safety margin, and the minimum operating pressure available. Refer to the pressure/torque table and select the minimum pressure column applicable. Follow this column down until a value not less than that required is found. Next read across to the left hand column and read the model number to be ordered. EXAMPLE: Valve torque 80Nm plus 25% = 100 Nm Minimum operating pressure 5 bar. By reading down the 5 bar column a figure without below 119 Nm is 123 Nm The model number therefore shown in the left hand column is AP4DA. Remark: the chosen torque valve, which fixes the type of actuator, has never to be lower than the requested torque value of the valve.*

MOMENTO TORCENTE - ATTUATORI A DOPPIO EFFETTO (DA) Nm - TORQUE OUTPUT DOUBLE ACTING ACTUATORS (DA)

		PRESSIONE DI ALIMENTAZIONE - OPERATING PRESSURE							
MODELLO MODEL	bar	2	3	4	5	6	7	8	
		PSI	30	44	58	73	87	102	116
AP1 DA	Nm	5.9	8.9	11.8	14.8	17.7	21.7	24.8	
	lbf.in	52.6	79.3	105.2	132	157.8	193.5	221.1	
AP2 DA	Nm	9.4	14.1	18.8	23.5	28.2	32.9	37.6	
	lbf.in	83.8	125.7	167.7	209.6	251.5	293.5	335.4	
AP3 DA	Nm	20	30	40	50	60	70	80	
	lbf.in	178.4	267.6	356.8	446	535.2	624.4	713.6	
AP3.5 DA	Nm	34	51	68	85	102	119	136	
	lbf.in	303.3	454.9	606.5	758.2	909	1061.5	1213.2	
AP4 DA	Nm	48	71	95	119	142	168	192	
	lbf.in	428.2	633.3	847.4	1061	1266.6	1498.5	1712.6	
AP4.5 DA	Nm	87.2	130.8	174.4	218	261.6	305.2	348.8	
	lbf.in	777.8	1166.7	1555.6	1944.5	2333.4	2722.3	3111.2	
AP5 DA	Nm	111	167	222	278	333	388.5	444	
	lbf.in	990.1	1489.6	1980.2	2479.7	2970.4	3465.4	3960.5	
AP5.5 DA	Nm	157.6	236.4	315.3	394.1	473	551.8	630.6	
	lbf.in	1405.7	2108.6	2812.4	3515.3	4219.1	4922	5624.9	
AP6 DA	Nm	227	340	454	567	680	794.5	908	
	lbf.in	2024.8	3032.8	4049.6	5057.6	6065.6	7087	8099.4	
AP8 DA	Nm	426	638	851	1064	1276	1491	1704	
	lbf.in	3800	5691	7591	9491	11382	13299	15200	

Note: The output torque of selected actuator should never be less the required valve torque

PNEUMATIC ROTARY ACTUATORS

AP SERIES

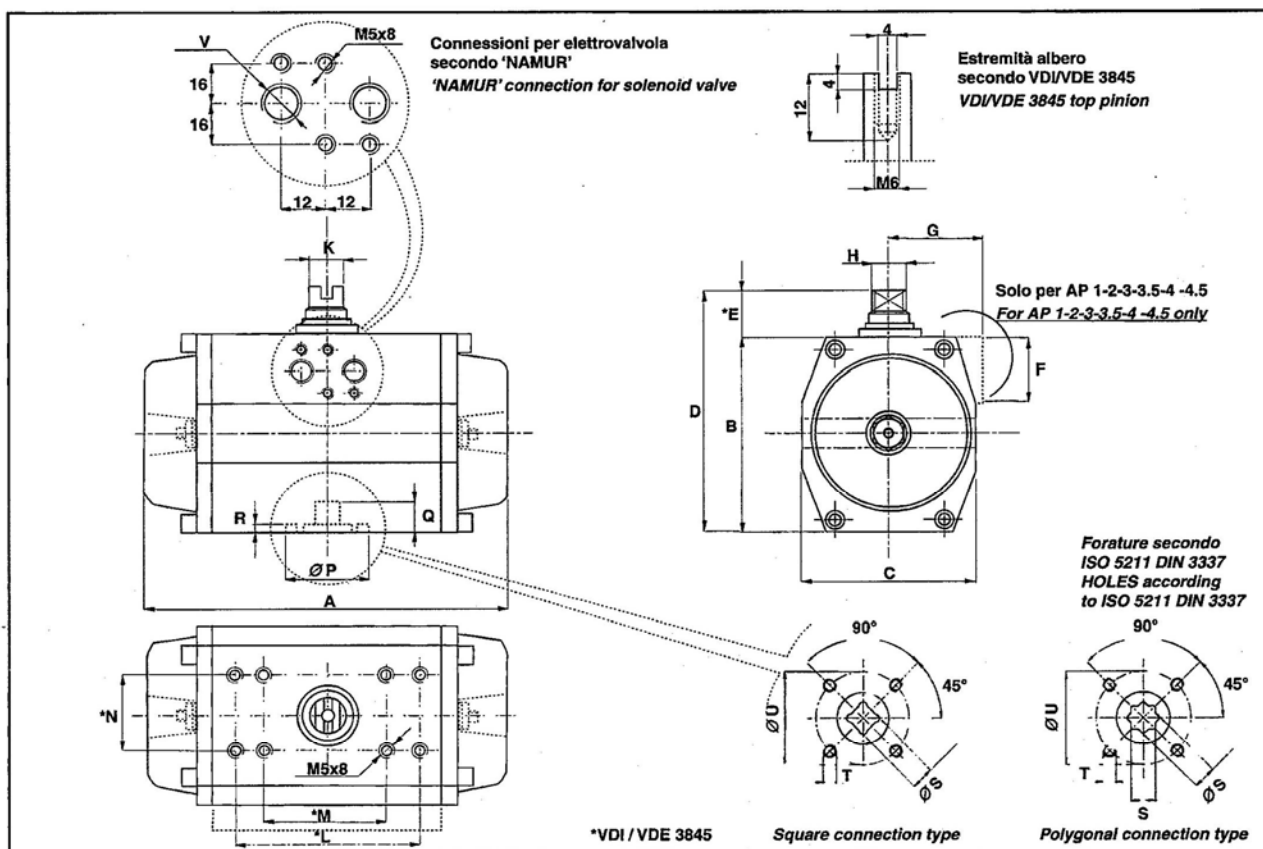

CONSUMO ARIA PER CORSA - AIR CONSUMPTION FOR STROKE (FREE AIR)

MODELLO - MODEL	AP1 DA/SR	AP2 DA/SR	AP3 DA/SR	AP3.5 DA/SR	AP4 DA/SR	AP4.5 DA/SR	AP5 DA/SR	AP5.5 DA/SR	AP6 DA/SR	AP8 DA/SR
In apertura <i>Counter clockwise</i>	Litri - Liters 0.08	0.12	0.24	0.48	0.68	1	1.4	1.6	3.2	5.3
	Cu.ft. 0.003	0.004	0.008	0.017	0.024	0.035	0.049	0.057	0.11	0.19
In chiusura (Solo DA) <i>Clockwise (DA only)</i>	Litri - Liters 0.10	0.16	0.44	0.56	0.96	1.6	2.16	2.56	4	8.6
	Cu.ft. 0.0035	0.006	0.016	0.020	0.034	0.057	0.076	0.09	0.14	0.30

PESI - WEIGHTS

MODELLO MODEL	AP1 DA	AP2 DA	AP3 DA	AP3.5 DA	AP4 DA	AP4.5 DA	AP5 DA	AP5.5 DA	AP6 DA	AP8 DA
Kg.	1.15	1.60	2.80	4.28	5.80	8.26	11.63	14.15	21.70	40.10
lbs.	2.53	3.53	6.17	9.44	12.79	18.21	25.64	31.20	47.85	88.42

DIMENSIONI - DIMENSIONS

MODELLO MODEL	A	B	C	D	E	F	G	H	K	L	M	N	P	Q	R	S	T	U	V	ISO 5211	
AP1 DA/SR	mm	137	67	60	87	20	42	41	12	8	-	80	30	25	10	2	9	M5/M6	36/50	1/8"	F03/F05
	ins.	5.39	2.64	2.36	3.43	0.79	1.65	1.61	0.47	0.31	-	3.15	1.18	0.98	0.39	0.08	0.35		1.42/1.97		
AP2 DA/SR	mm	150	83	73	103	20	42	44.5	12	8	-	80	30	30/35	12	2	11	M5/M6	42/50	1/4"	* F04/F05
	ins.	5.91	3.27	2.87	4.06	0.79	1.65	1.75	0.47	0.31	-	3.15	1.18	1.18/1.36	0.47	0.08	0.43		1.65/1.97		
AP3 DA/SR	mm	204	100	85	120	20	50	49.5	14	10	-	80	30	35	16	3	14	M6/M8	50/70	1/4"	F05/F07
	ins.	8.03	3.94	3.35	4.72	0.79	1.97	1.95	0.55	0.39	-	3.15	1.18	1.38	0.63	0.12	0.55		1.97/2.76		
AP3.5 DA/SR	mm	230	110	98	130	20	50	53	19	14	-	80	30	55	20	3.5	17	M8	70	1/4"	F07
	ins.	9.06	4.33	3.86	5.12	0.79	1.97	2.09	0.75	0.55	-	3.15	1.18	2.17	0.79	0.14	0.67		2.76		
AP4 DA/SR	mm	271	125	110	145	20	50	58	19	14	-	80	30	55	20	3.5	17	M8/M10	70/102	1/4"	F07/F10
	ins.	10.67	4.92	4.33	5.71	0.79	1.97	2.28	0.75	0.55	-	3.15	1.18	2.17	0.79	0.14	0.67		2.76/4.02		
AP4.5 DA/SR	mm	305	142	128	172	30	58	69	28	20	130	80	30	70	24	3.5	22	M10	102	1/4"	F10
	ins.	12.01	5.59	5.04	6.77	1.18	2.28	2.72	1.10	0.79	5.12	3.15	1.18	2.76	0.94	0.14	0.87		4.02		
AP5 DA/SR	mm	360	155	140	185	30	-	-	28	20	130	80	30	70	24	3.5	22	M10	102	1/4"	F10
	ins.	14.17	6.10	5.51	7.28	1.18	-	-	1.10	0.79	5.12	3.15	1.18	2.76	0.94	0.14	0.87		4.02		
AP5.5 DA/SR	mm	380	176	160	206	30	-	-	36	28	130	80	30	85	29	3.5	27	M12	125	1/4"	F12
	ins.	14.96	6.93	6.30	8.11	1.18	-	-	1.42	1.10	5.12	3.15	1.18	3.35	1.14	0.14	1.06		4.92		
AP6 DA/SR	mm	462	200	175	230	30	-	-	36	28	130	80	30	85	29	3.5	27	M12	125	1/4"	F12
	ins.	18.19	7.87	6.89	9.06	1.18	-	-	1.42	1.10	5.12	3.15	1.18	3.35	1.14	0.14	1.06		4.92		
AP8 DA/SR	mm	555	250	215	300	50	-	-	48	32	130	-	30	100	38	5	36	M16	140	1/4"	F14
	ins.	21.85	9.84	8.46	11.81	1.97	-	-	1.89	1.26	5.12	-	1.18	3.94	1.50	0.20	1.42		5.51		

★ Foratura da specificare in caso di ordine

★ To be chosen when ordering

PNEUMATIC ROTARY ACTUATORS

AP SERIES

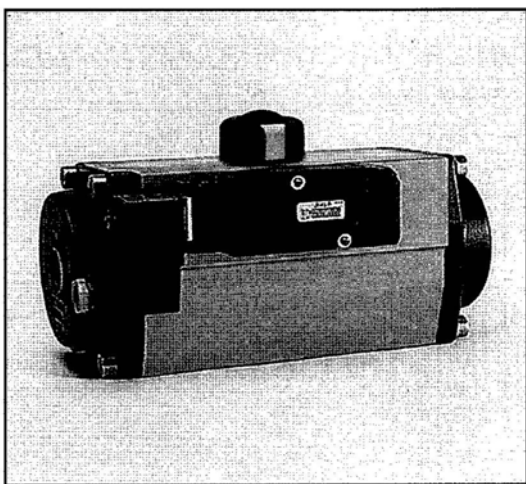

Attuatore pneumatico serie AP DA/SR con elettrovalvola NAMUR.
AP series DA/SR pneumatic actuator with NAMUR solenoid valve.

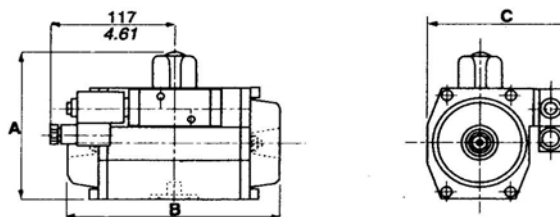

MODELLO MODEL	A		B		C	
	mm	ins.	mm	ins.	mm	ins.
AP1 DA/SR	97	3.82	137	5.39	109	4.29
AP2 DA/SR	113	4.45	150	5.91	119	4.69
AP3 DA/SR	130	5.12	204	8.03	130	5.19
AP3.5 DA/SR	140	5.51	230	9.06	140	5.51
AP4 DA/SR	155	6.10	271	10.67	151	5.94
AP4.5 DA/SR	182	7.17	305	12.01	171	6.73
AP5 DA/SR	197	7.76	360	14.17	178	7.01
AP5.5 DA/SR	218	8.58	380	14.96	198	7.80
AP6 DA/SR	242	9.53	462	18.19	213	8.39
AP8 DA/SR	312	12.28	530	20.87	253	9.96

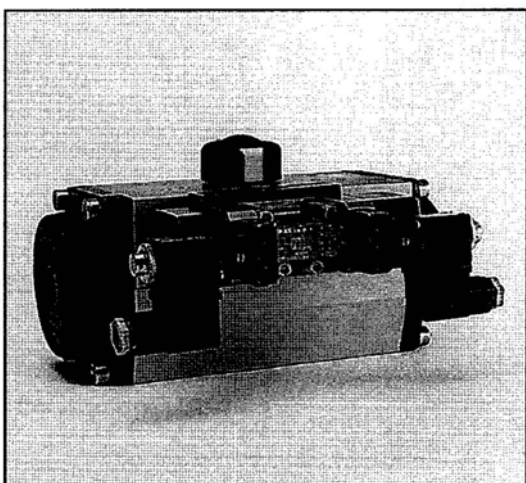

Attuatore pneumatico serie AP DA/SR con elettrovalvola ISO 5599/1 Tg.1.
AP series DA/SR pneumatic actuator with ISO 5599/1 solenoid valve Size 1.

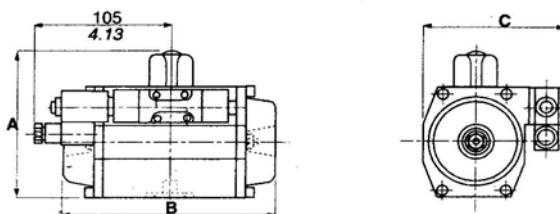

MODELLO MODEL	A		B		C	
	mm	ins.	mm	ins.	mm	ins.
AP1 DA/SR	97	3.82	137	5.39	151	5.94
AP2 DA/SR	113	4.45	150	5.91	161	6.34
AP3 DA/SR	130	5.12	204	8.03	172	6.77
AP3.5 DA/SR	140	5.51	230	9.06	182	7.17
AP4 DA/SR	155	6.10	271	10.67	193	7.60
AP4.5 DA/SR	182	7.17	305	12.01	213	8.39
AP5 DA/SR	197	7.76	360	14.17	220	8.66
AP5.5 DA/SR	218	8.58	380	14.96	240	9.45
AP6 DA/SR	242	9.53	462	18.19	255	10.04
AP8 DA/SR	312	12.28	530	20.87	295	11.61

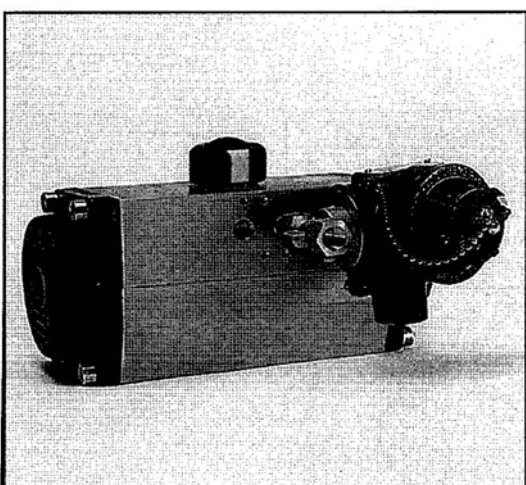

Attuatore pneumatico serie AP DA/SR con elettrovalvola in esecuzione ADPE (antideflagrante).
AP series DA/SR pneumatic actuator with solenoid valve EX-PROOF style.

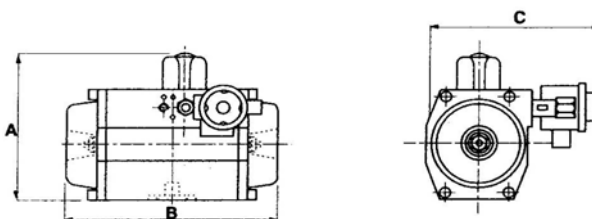

MODELLO MODEL	A		B		C	
	mm	ins.	mm	ins.	mm	ins.
AP1 DA/SR	97	3.82	137	5.39	171	6.73
AP2 DA/SR	113	4.45	150	5.91	181	7.13
AP3 DA/SR	130	5.12	204	8.03	192	7.56
AP3.5 DA/SR	140	5.51	230	9.06	202	7.95
AP4 DA/SR	155	6.10	271	10.67	213	8.39
AP4.5 DA/SR	182	7.17	305	12.01	233	9.17
AP5 DA/SR	197	7.76	360	14.17	240	9.45
AP5.5 DA/SR	218	8.58	380	14.96	260	10.24
AP6 DA/SR	242	9.53	462	18.19	275	10.83
AP8 DA/SR	312	12.28	530	20.87	315	12.40

PNEUMATIC ROTARY ACTUATORS

AP SERIES

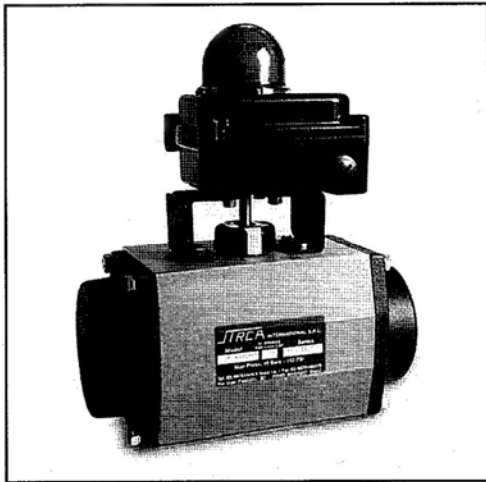

Attuatore pneumatico serie AP DA/SR con finecorsa meccanici, antideflagranti EExd, pneumatici, di prossimità amplificati PNP ed a sicurezza intrinseca EExia Namur racchiusi in box stagno IP 65.

AP series DA/SR pneumatic actuator with mechanical, explosion proof EExd, pneumatic amplified proximity PNP and intrinsically safety EExia Namur micro switches which are contained in IP 65 waterproof box.

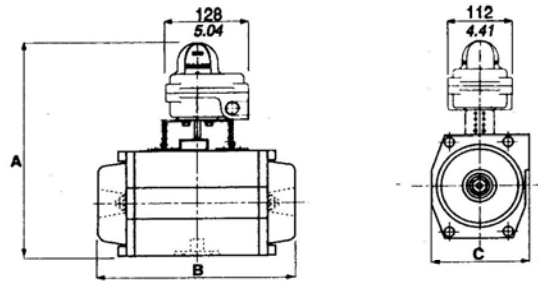

MODELLO MODEL	A		B		C	
	mm	ins.	mm	ins.	mm	ins.
AP1 DA/SR	237	9.33	137	5.39	71	2.80
AP2 DA/SR	253	9.96	150	5.91	81	3.19
AP3 DA/SR	270	10.63	204	8.03	92	3.62
AP3.5 DA/SR	280	11.02	230	9.06	102	4.02
AP4 DA/SR	295	11.61	271	10.67	113	4.45
AP4.5 DA/SR	322	12.68	305	12.01	133	5.24
AP5 DA/SR	335	13.19	360	14.17	140	5.51
AP5.5 DA/SR	356	14.02	380	14.96	160	6.30
AP6 DA/SR	380	14.96	462	18.19	175	6.89
AP6 DA/SR	450	17.72	555	21.85	215	8.46

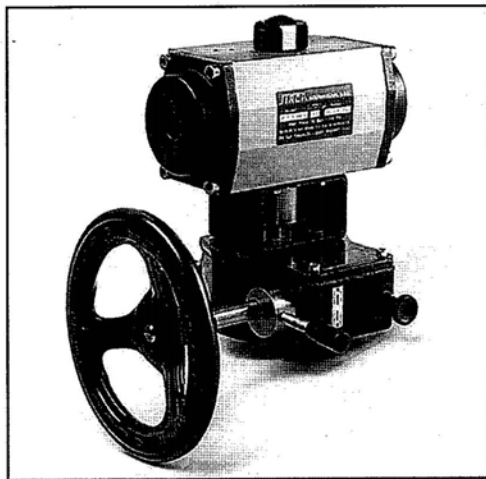

Attuatore pneumatico serie AP DA/SR con riduttore ad ingranaggi a volantino disinnestabile.

AP series DA/SR pneumatic actuator with disengageable manual override gear box.

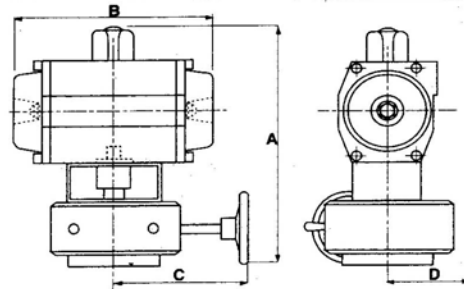

MODELLO MODEL	A		B		C		D	
	mm	ins.	mm	ins.	mm	ins.	mm	ins.
AP1 DA/SR	287	11.30	137	5.39	214	8.43	167	6.57
AP2 DA/SR	303	11.93	150	5.91	214	8.43	167	6.57
AP3 DA/SR	320	12.60	204	8.03	214	8.43	167	6.57
AP3.5 DA/SR	330	12.99	230	9.06	214	8.43	167	6.57
AP4 DA/SR	345	13.58	271	10.67	214	8.43	167	6.57
AP4.5 DA/SR	372	14.65	305	12.01	214	8.43	167	6.57
AP5 DA/SR	387	15.24	360	14.17	214	8.43	167	6.57
AP5.5 DA/SR	460	18.11	380	14.96	343	13.50	247	9.72
AP6 DA/SR	484	19.06	462	18.19	343	13.50	247	9.72
AP6 DA/SR	554	21.81	555	21.85	343	13.50	247	9.72

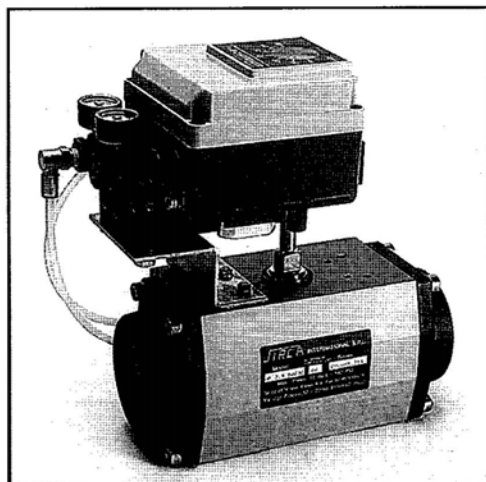

Attuatore pneumatico serie AP DA/SR con posizionatore pneumatico segnale 3-15/3-9/9-15 P.S.I. o elettropneumatico seg. tale 4+20mA

AP series DA/SR pneumatic actuator with pneumatic positioner 3 + 15/3 + 9/9 + 15 P.S.I. signal or elettropneumatic positioner 4+20mA signal.

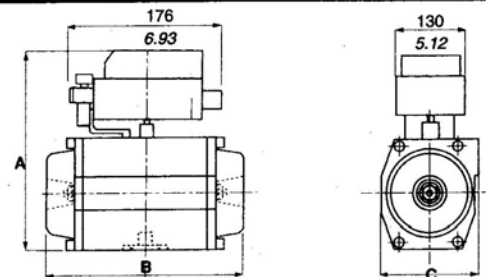

MODELLO MODEL	A		B		C	
	mm	ins.	mm	ins.	mm	ins.
AP1 DA/SR	167	6.57	137	5.39	71	2.80
AP2 DA/SR	183	7.20	150	5.91	81	3.19
AP3 DA/SR	200	7.87	204	8.03	92	3.62
AP3.5 DA/SR	210	8.27	230	9.06	102	4.02
AP4 DA/SR	225	8.86	271	10.67	113	4.45
AP4.5 DA/SR	252	9.92	305	12.01	133	5.24
AP5 DA/SR	255	10.04	360	14.17	140	5.51
AP5.5 DA/SR	286	11.26	380	14.96	160	6.30
AP6 DA/SR	300	11.81	462	18.19	175	6.89
AP6 DA/SR	350	13.73	530	20.87	215	8.46