

USER MANUAL



JUNIOR JR-P / JR20-P

**UNIVERSAL DIGITAL INDICATOR
FOR PROCESS, TEMPERATURE
AND RESISTANCE INPUT SIGNAL**

INDEX
GENERAL INFORMATION

Package contents	4
Recycling instructions	4
General safety considerations	4
Symbols identification	4
Maintenance	5
Warranty	5
Conformity declaration	6
Device description	7
Dimensions and mounting	7
Display and keyboard	8
Installing and connecting recommendations	8
Connections	9
Process input (V)	9
Process input (mA)	10
Potentiometer input	10
Pt100 and Pt1000 sensor input	11
Thermocouple (J, K, T and N) input	11
Resistance input	11
Relays output	11

INPUT CONFIGURATION

Configuration menu	12
Input configuration	12
Process	13
Temperature	13
Potentiometer	13
Resistance	14

DISPLAY CONFIGURATION

Display programming	15
Display scaling	15
Process input	16
Temperature input	16
Potentiometer input	17
Resistance input	17

SETPOINTS CONFIGURATION

Setpoints configuration	18
-------------------------------	----

AVAILABLE KEYBOARD FUNCTIONS

MAX/MIN and RESET functions	19
Direct access to setpoints value	19
Return to default configuration	19
Access to lock-out configuration menu	20

CONFIGURATION LOCK-OUT

Lock-out menu	21
---------------------	----

OUTPUT OPTION

Description	23
Function modes description	23
HI/LO mode activation	23
Time delay	23
Asymmetrical hysteresis	23
Installation	24

INDEX

SPECIFICATIONS

Technical specifications 25

GENERAL INFORMATION

This manual does not constitute a contract or a commitment on the part of Diseños y Tecnología, S.A. All information contained in this document is subject to change without prior notice.

MANUAL VALID FOR INSTRUMENTS WITH P2.02 SOFT VERSION OR HIGHER

Package contents

With the instrument it is also supplied:

- Quick installation guide.
- Mounting panel accessories (a sealing gasket and 2 fixing clips).
- Wiring accessories (plug-in terminal block connectors and 2 key tools for cable insertion).
- 4 adhesive labels set with engineering units.

Recycling instructions

This electronic instrument is covered by the **2002/96/CE** European Directive so, it is properly marked with the crossed-out wheeled bin symbol that makes reference to the selective collection for electrical and electronic equipment which indicates that at the end of its lifetime, the final user cannot dispose of it as unsorted municipal waste.



In order to protect the environment and in agreement with the European legislation regarding waste of electrical and electronic equipments from products put on the market after 13 August 2005, the user can give it back, without any cost, to the place where it was acquired to proceed to its controlled treatment and recycling.

General safety considerations

All instructions and guidelines for the installation and manipulation that are present in this manual must be considered to ensure personal safety and to prevent damage to either the instrument or any equipment connected to it.

Safety of any equipment incorporated to this instrument is responsibility of the system installer.

If this electronic indicator is used in a manner not specified by the manufacturer in this manual, the protection provided by the instrument may be impaired.

Symbols identification



WARNING: Potential risk of danger.

Read completely related instructions when this symbol appears in order to know the potential risk and to know how to avoid it.



WARNING: Risk of electric shock.



Instrument protected by double isolation or reinforced isolation.

Maintenance

To guarantee instrument accuracy, it is recommended to checking its compliance according to the technical specifications listed in this manual, performing calibrations regularly in accordance to operation criteria in each application.

Instrument calibration and/or adjustment should be performed only by an accredited laboratory or directly by the manufacturer.

Instrument repairs should only be carried out by the manufacturer or by its authorized partners.

For frontal device cleaning, just wipe it with a damp cloth and neutral soap product. **DO NOT USE SOLVENTS!**

Warranty

All products are warranted against defective material and workmanship for a period of three years from acquisition date.



If a product appears to have a defect or fails during the normal use within warranty period, please contact the distributor from whom you purchased the product to be given proper instructions.

This warranty does not apply to defects resulting from action of the customer such as mishandling or improper interfacing.

The liability under this warranty shall extend only to the repair of the instrument; no responsibility is assumed by the manufacturer for any damage which may result from its use.



All DITEL products benefit from an unlimited and unconditional warranty of three (3) years from the date of their purchase. Now you can extend this period up to five (5) years from the product commissioning, only by fulfilling the corresponding form.

Conformity declaration

EN 61326-1	Electrical equipment for measurement, control and laboratory use (EMC)	
EN 61000-4-2	Electrostatic discharge (ESD) Air discharge 8kV Contact discharge 4kV	Criterion B
EN 61000-4-3	Electromagnetic fields 10 V/m	Criterion A
EN 61000-4-4	Fast transients (burst) Power lines 2 kV Signal lines 1 kV	Criterion B
EN 61000-4-5	Surge 1 kV L to N 2 kV L,N to Earth 1 kV Signal lines to Earth	Criterion B
EN 61000-4-6	RF conducted interference 3 Vrms	Criterion A
EN 61000-4-11	Voltage dips: 0% V during 1 cycle 40% V during 10/12 cycles 70% V during 25/30 cycles Short interruptions: 0% V during 250/300 ciclos	Criterion B Criterion C Criterion C Criterion C
CISPR11	Emission limits Class B	
EN 61010-1	Safety requirements for electrical equipment for measurement, control and laboratory use.	
	General safety Overvoltage category II Pollution degree 2 Conductive pollution excluded Isulation type: Enclosure: Double Power/signal/relays: Basic	

Device description

All information contained in this manual, unless indicated, is valid for both **JR-P** and **JR20-P** models.

JR-P and **JR20-P** models from KOSMOS serie are universal digital indicators fully configurables that allow input type selection in order to be used as needed. Available signal inputs are the following:

PROCESS (V, mA)
THERMOCOUPLE (J, K, T y N)
Pt100 and **Pt1000 SENSOR**
POTENTIOMETER
RESISTANCE

The basic instrument consists of a soldered assembly composed of a main board, a display and an input signal circuits. It can also be incorporated, as an option, an extra plug-in 2 SPDT 8A relays circuit output which is isolated from signal input and power supply. This extra circuit has independent connectors that are located on the rear part of the instrument once it is installed.

Specially designed for the control of industrial processes and monitoring input variables, both models have 4 digits, configurable decimal point and 2 LED's for setpoints status indication, they are easy to scale into desired engineering units, directly by frontal keys or rear input signal value in teach mode. They also provide a 24V DC output for sensor excitation.

JR-P model is provided with **14mm-high** digits and maximum display range of **-9999** to **9999** whereas **JR20-P** has **20mm-high** digits and a maximum range of **-1999** to **9999**. **JR20-P** has a larger display to provide a better reading at longer distance, although minus LED sign is integrated in the most significative digit instead of being external, as in **JR-P** model.

Both devices have three frontal keys to interact with internal software and set configuration in order to adapt their function to particular applications. Device programming runs through some independent menus that show short messages to easily identify input type and/or display configuration steps.

If relays output option card is installed, once it is recognised by the instrument, activates its own configuration menu which is only visible under this conditions.

Dimensions and mounting

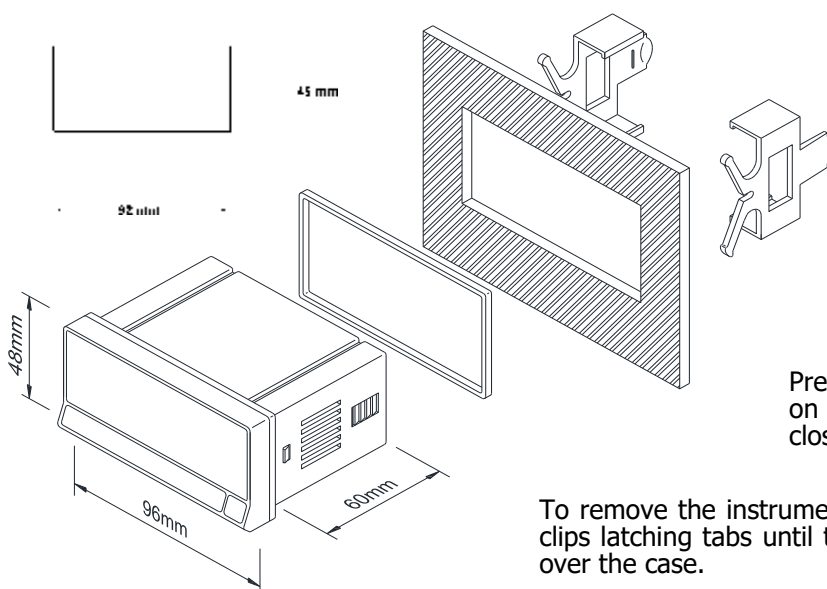

To install the instrument, prepare a 92x45mm panel cut-out and slide the unit inwards making sure of placing the sealing gasket between the front side panel and the frontal bezel.

While holding the unit in place, put the fixing clips on both sides of the case and slide them through the guide tracks until they reach the panel at the rear side.

Press slightly to fasten the clips to the latching slots on the case and get the unit fully assembled and close fitted to achieve a good sealing.

To remove the instrument from the panel, pull outwards the rear fixing clips latching tabs until they are disengaged, then slide fixing clips back over the case.

Display and keyboard

There are two main function modes: **RUN** and **PRO**. **PRO** mode is when configuration menu is entered to programm the indicator, whereas **RUN** is the normal mode in which display shows the reading according to configuration and input signal value.

The table below summarizes display parts description and LEDs and keyboard function.

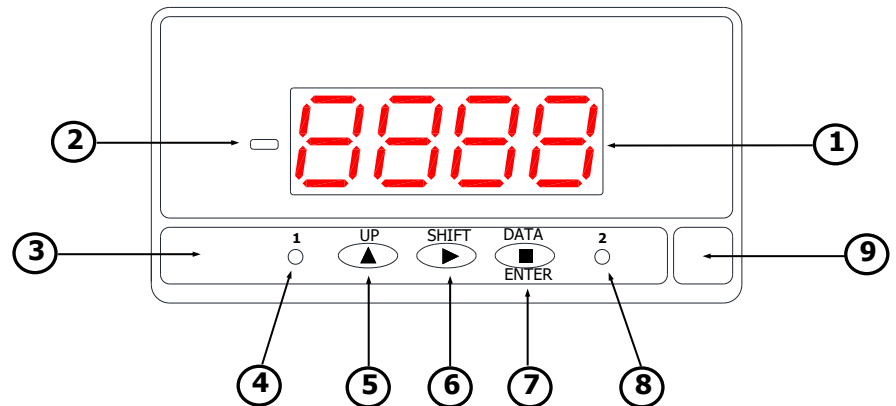

		RUN MODE	PRO MODE
1	4 red digit Display	Shows value according configuration.	Shows steps and data during configuration.
2	Minus sign LED (only for JR-P)	It iluminates for negative readings.	It iluminates for negative values.
3	Keyboard	—	—
4	Setpoint 1 LED	It iluminates when Setpoint 1 turns active.	It iluminates when Setpoint 1 turns active.
5	UP key	No application.	Shows Setpoints value. Increases value of active digit.
6	SHIFT key	Displays maximum and minimum stored values. After 3s of pressing, sets maximum and/or minimum memorized value to current display value.	Shifts active digit to the next right digit. Shows sequentially menu options.
7	DATA/ENTER key	Changes to PRO mode.	Validates selected data and parameters. Moves one step forward in configuration menu. Changes to RUN mode.
8	Setpoint 2 LED	It iluminates when Setpoint 2 turns active.	It iluminates when Setpoint 2 turns active.
9	Free space for units label	—	—

Installing and connecting recommendations

This instrument coforms with the following community directives: EMC 2004/108/CE and LVD 2006/95/CE. Refer to the instructions in this manual to preserve safety protections.



WARNING: If this instrument is not installed and used in accordance with this instructions, the protection provided by it against hazards may be impaired.

To meet the requirements of EN 61010-1 standard, where the unit is permanently connected to main supply, its is obligatory to install a circuit breaking device easy reachable to the operator and clearly marked as the disconnecting device.

To guarantee electromagnetic compatibility, the following guidelines should be kept in mind:

- Power supply wires should be separatedly routed from signal wires and **never runned** in the same conduit.
- Use shielded cable for signal wiring.
- Cables section should be $\geq 0.25 \text{ mm}^2$.

Before connecting signal wires, signal type and input range should be verified to be within the right limits. **Do not connect simultaneously more than one input signal to the meter.**

Connections

Basic instrument has two rear connectors **CN1** and **CN2**. If 2RE output option card is installed, two more connectors **CN3** and **CN4** appear. See all four connectors location and their pin out in the right figure. All female provided terminal connectors are of CAGE CLAMP® technology.

Terminals for **CN2** connector admit cables with section from 0.2mm² up to 1.5mm² (AWG 24÷14).

Terminals for **CN1**, **CN3** and **CN4** connectors admit cables with section from 0.08mm² up to 2.5mm² (AWG 28÷12).

To perform wiring connections, strip the cable leaving from 7 to 10mm exposed to air, insert it in the proper terminal while pushing down the key insertion tool to open the clip inside the connector. Release the key tool to fix wire to the terminal.

Proceed in the same way for the rest of terminals. Once all connections are done, plug connectors to the instrument.

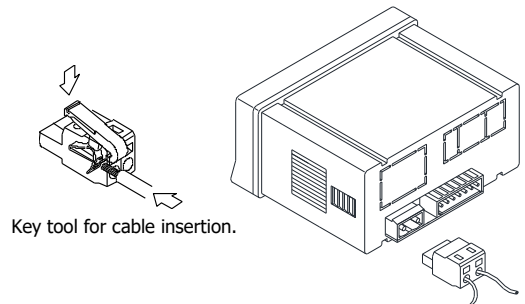
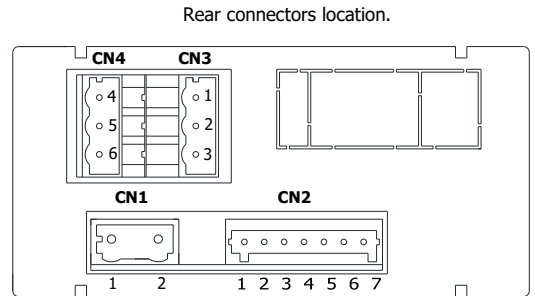

CN4 (relay 2)	
4	NO
5	CM
6	NC

CN3 (relay 1)	
1	NO
2	CM
3	NC

CN1*	
1	Phase (AC)
2	Neutral (AC)

CN2	
1	COMMON / Pt100 / Pt1000 / -TC / Pot. Term. 1
2	Pt100 / Pt1000 / +TC / IN 1kΩ-10kΩ / Pot. Cursor
3	IN 50kΩ / Pot. Term. 2
4	Common Pt100
5	+mA
6	+EXC. 24V / 10V (*)
7	+V

Notes:

NO: Normally open contact.

CM: Common contact.

NC: Normally closed contact.

* Polarity in CN1 is indistinct for DC power.

(*) SELECTION OF SENSOR EXCITATION
Set jumper to desired position 10V or 24V.
(Default 24V)



WARNING

Isolation:

1500Vrms for 1 minute to signal terminals (CN2) and power terminals (CN1).
2500Vrms for 1 minute to signal terminals (CN2) and relays terminals (CN3 y CN4).
2500Vrms for 1 minute to power terminals (CN1) and relays terminals (CN3 y CN4).

Process input signal wiring diagrams (V)

4 WIRES CONNECTION WITH EXTERNAL EXCITATION

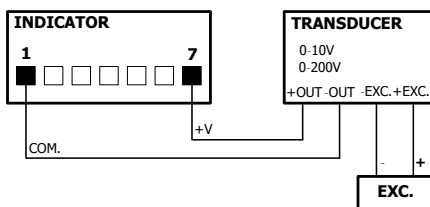

4 WIRES CONNECTION WITH EXCITATION SUPPLIED BY THE INDICATOR

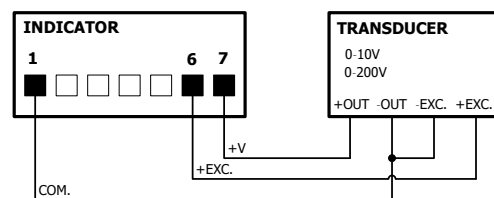

3 WIRES CONNECTION WITH EXTERNAL EXCITATION

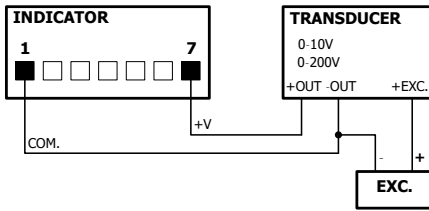

3 WIRES CONNECTION WITH EXCITATION SUPPLIED BY THE INDICATOR

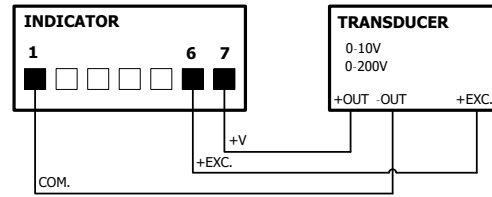

Process input signal wiring diagrams (mA)

4 WIRES CONNECTION WITH EXTERNAL EXCITATION

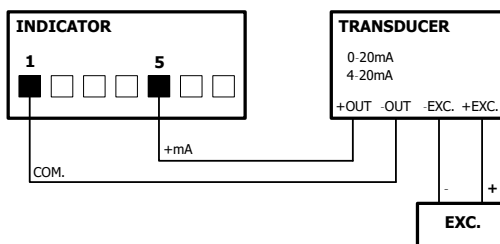

4 WIRES CONNECTION WITH EXCITATION SUPPLIED BY THE INDICATOR

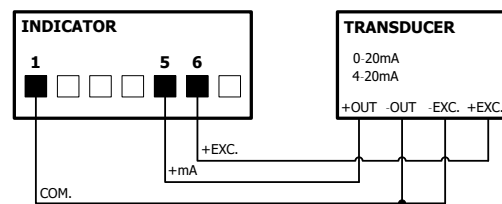

3 WIRES CONNECTION WITH EXTERNAL EXCITATION

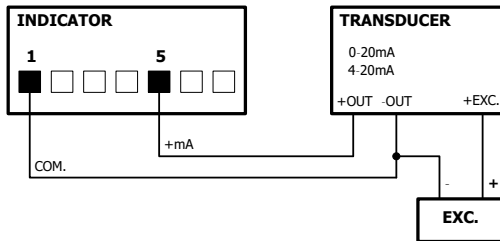

3 WIRES CONNECTION WITH EXCITATION SUPPLIED BY THE INDICATOR

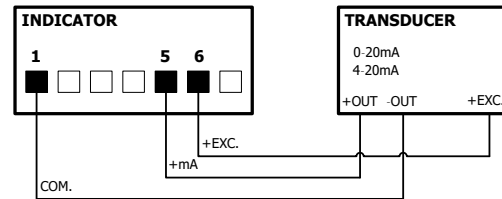

2 WIRES CONNECTION WITH EXTERNAL EXCITATION

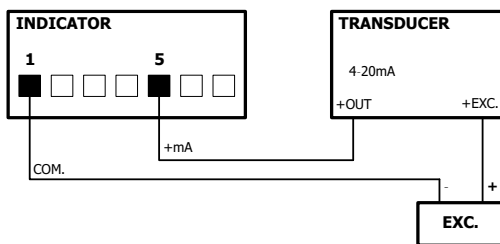

2 WIRES CONNECTION WITH EXCITATION SUPPLIED BY THE INDICATOR

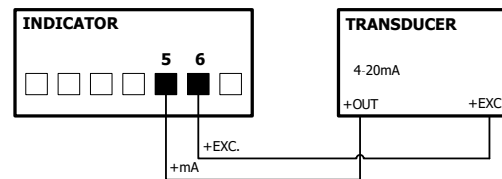

Potentiometer input wiring diagram (Ω)

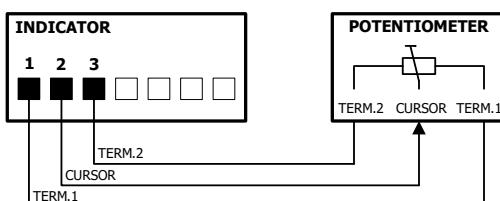

NOTE:

Do not perform measurements with potentiometer subjected to external voltage, since it may interfere in the measure, altering the reading and even cause serious damages on this unit.

Pt100 and Pt1000 sensor input wiring diagram (°C)

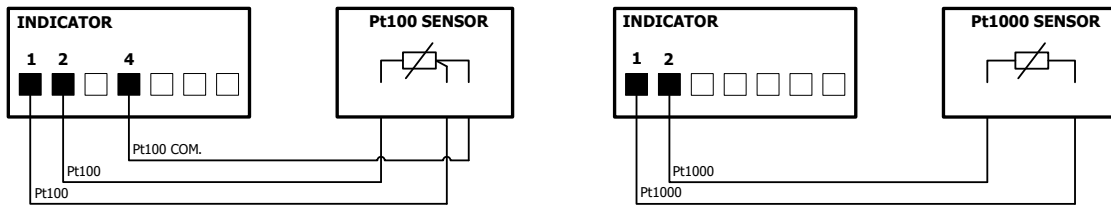

Thermocouple J, K, T and N input wiring diagram (°C or °F)

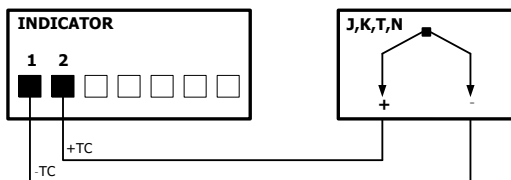

Resistance input wiring diagram (Ω)

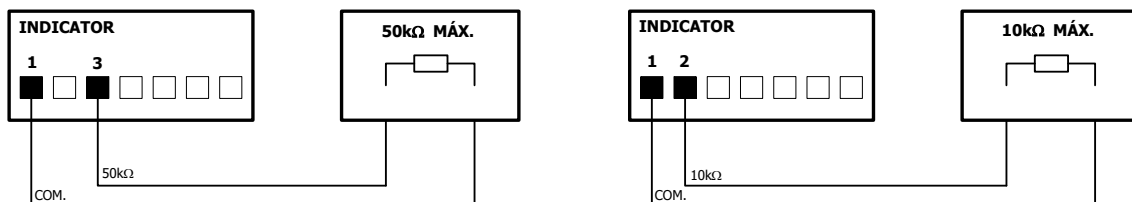

NOTE:

Do not perform measurements with resistance subjected to external voltage, since it may interfere in the measure, altering the reading and even cause serious damages on this unit.

Relays output wiring

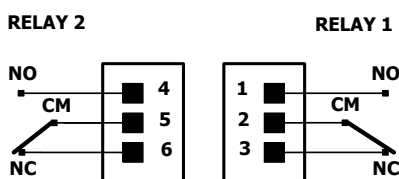

8A/250V MAX.



WARNING:

Read recommendations and related data on pages 8 and 9.

IMPORTANT:

To guarantee electrical safety according to EN 61010-1 a protective **8A/250V** external fuse must be installed.

INPUT CONFIGURATION

Configuration menu



When connecting instrument to Power supply, display test begins automatically to check the good function of LED's and digits, once this test is finished, display shows internal software version and then the unit goes to **RUN** mode.

Configuration software has a hierarchical structure composed of a number of menus and submenus. By pressing **ENTER** key, display shows "**Pro**", a new pressing brings access to main menu where appear configuration menus, that is, input configuration (**InP**), display configuration (**dSP**) and setpoints configuration (**SEtP**). This last menu only appears if 2RE output option card is installed.

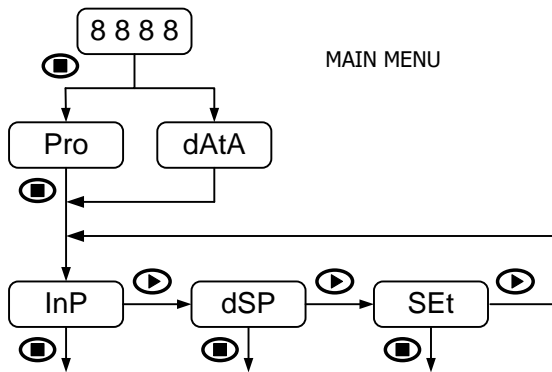
If configuration is totally locked-out, when pressing **ENTER** key to get into main menu, display shows "**dAtA**" instead of "**Pro**". This indicates that it is only possible to see programmed information and that it is not allowed to modify any parameter from the entire configuration. In this visualization mode, the instrument automatically switches back to **RUN** mode after 15 seconds since last key press.



The instrument provides 3 keys for progressing through the menus and submenus and for data introducing/modifying:

-  **ENTER**: Vertical displacement / Validates data.
-  **UP**: Increases active digit value.
-  **SHIFT**: Horizontal displacement / Changes active digit.

Once inside each menu, all configuration parameters are sequentially shown and they can then be introduced or edited by pressing **ENTER** key. Numeric values must be entered digit by digit, first selecting digit and then changing its value. When the display reach desired value, a new **ENTER** key pressing validates data and routine goes forward to next configuration step.

Data entered or changes made during configuration are stored in device memory only when programming routine belonging to the respective submenu is completed, not before. On last routine step and after having pressed **ENTER** key, display indicates "**StorE**" and the unit goes back again to **RUN** mode.

Input configuration

The first menu corresponds to input configuration. This, in turn, consists of four submenus, one for each input type: process (**ProC**), temperature (**tEMP**), potentiometer (**Pot**) and resistance (**rES**).

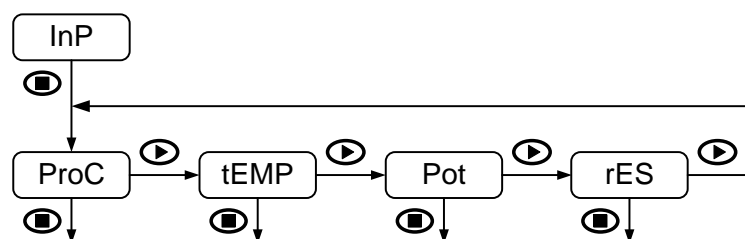

Process

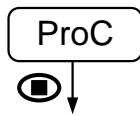

The parameters to be configured in input process submenu are:

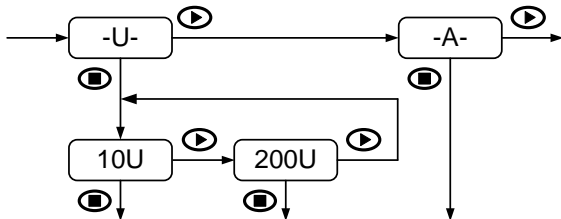

INPUT TYPE:

V DC: $\pm 10V$ or $\pm 200V$ (-tachometric dynamo-)
A DC: $\pm 20mA$ (single range, direct validation)

Temperature

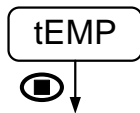

The parameters to be configured in input temperature submenu are:

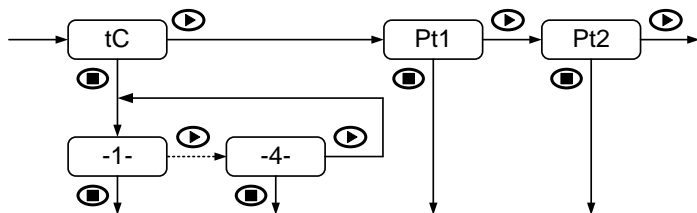

SENSOR TYPE:

tC: Termocouple **J**(1), **K**(2), **T**(3) or **N**(4)
Pt1: Pt100 sensor (direct validation)
Pt2: Pt1000 sensor (direct validation)

RESOLUTION TYPE:

1°C: Celsius degrees
0.1°C: Tenths of degree Celsius
1°F: Fahrenheit degrees
0.1°F: Tenths of degree Fahrenheit

DISPLAY OFFSET :

Configurable value:
-9.9 to +9.9 display counts if a tenths of degree resolution is selected
-99 to +99 display counts if a degree resolution is selected

Usually it will not be necessary to introduce any offset value, except in cases where a known difference between temperature captured by the sensor and real temperature should be compensated.

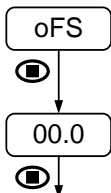

Potentiometer

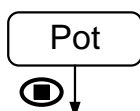

No additional configuration is needed for this input type (direct validation).

Resistance

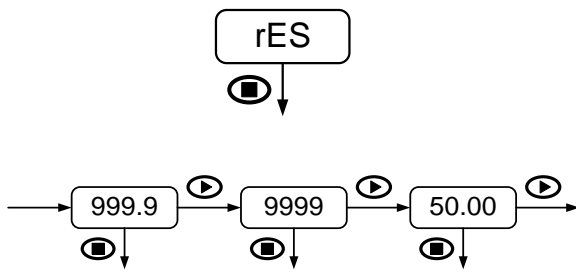

The only parameter to be configured in input temperature submenu is:

RESISTANCE RANGE:

999.9: **999.9Ω** (1kΩ) Range

9999: **9999Ω** (10kΩ) Range

50.00: **50.00kΩ** (50kΩ) Range

DISPLAY CONFIGURATION

Display Programming

The second menu corresponds to display configuration. This, in turn, consists of some submenus according to previously programmed input type: through frontal keys configuration (**SCAL** or **uSEr**), through real input signal (**TEACH**) (**tEAC**), calibrated range (**CAL**) and reading stabilization filter (**FiLt**).

TRHOUGH FRONTAL KEYS CONFIGURATION "SCAL"

Input and display values are configured **manually through the three keys** of the instrument. This method is suitable when signal values supplied by the transducer at each extreme point of the process are known.

REAL INPUT SIGNAL CONFIGURATION "tEAC"

Input values are **directly introduced from CN2 input connector just at the moment of signal capturing at each point of the process**. Display values are configured manually through the three keys, as in the previous case. This method is suitable when signal values at each point are unknown but, it is possible to lead process to the conditions defined by these extreme points.

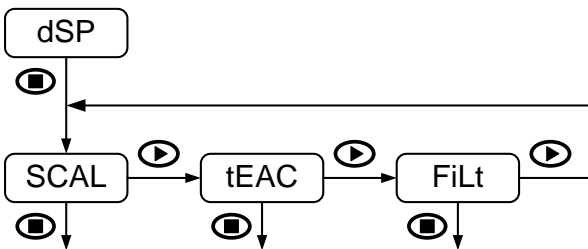

WEIGHTED AVERAGE FILTER "FiLt"

Sets low-pass filter cutoff frequency (Fc) which allows the instrument to smooth out undesirable display reading fluctuations.

Display scaling

Display scaling is necessary when adapting display reading to a particular engineering unit. Display range can be configured between **-9999** and **9999** for **JR-P** (14mm-high digits) or between **-1999** and **9999** for **JR20-P** (20mm-high digits).

Display scaling is a linear process that consists in introducing two input values, referred as **Input 1** and **Input 2**, and their respective display values, referred as **Display 1** and **Display 2**. On the basis of this proportional relationship internal software calculates display value that would correspond to a given input value. Decimal point position would complete required engineering units indication.

It is possible to scale display in an increasing or decreasing proportional mode depending on whether if second display value (**DISP.2**) is greater or less than the first (**DISP.1**). In an increasing mode, display value increases proportionally to the input value whereas in a decreasing mode, display value decreases. The left figure below shows both scaling modes.

IMPORTANT IN "tEAC" MODE:

To ensure the best accuracy, both points 1 and 2 should represent extreme process limits.

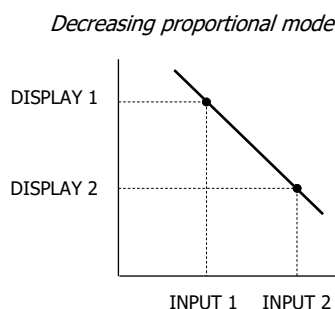
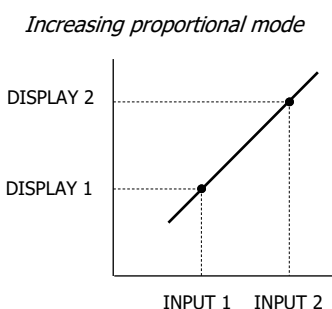

The right figure shows an example for a 10 bar pressure sensor with a 4-20mA output signal. Decimal point is situated between second and third digit of the display.

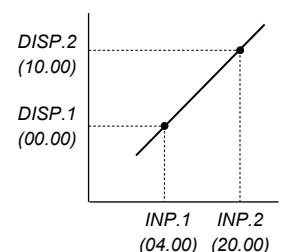

Process input

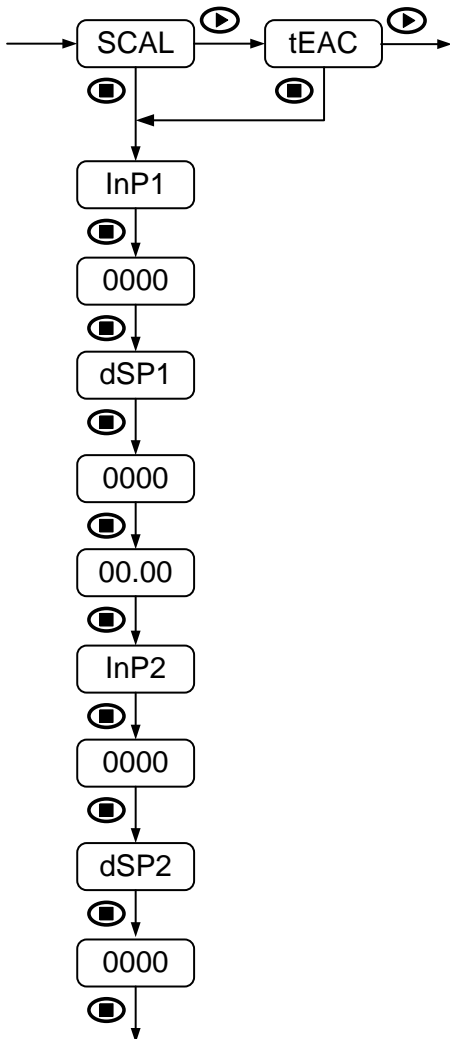

When programmed input type is process, for both display scaling "SCAL" and "tEAC" methods, parameters to be sequentially introduced are identical.

It only must be considered that in "SCAL" method, all values must be manually introduced through the three frontal keys whereas in "tEAC" method, input signal value must be present at the connector at each point that is intended to be configured.

FIRST POINT INPUT AND DISPLAY VALUE:

- InP1:** Input value indication.
- 0000:** Value entering in counts within available model display range.
- dSP1:** Display value indication.
- 0000:** Value entering in counts within available model display range.

DECIMAL POINT:

- 00.00:** Setting of decimal point position.
(Decimal point can be located in any position, and will be the same for Display 1 and Display 2. This position remains fixed for all configuration steps and also for **RUN** mode).

SECOND POINT INPUT AND DISPLAY VALUE:

- InP2:** Input value indication.
- 0000:** Value entering in counts within available model display range.
- dSP2:** Display value indication.
- 0000:** Value entering in counts within available model display range.

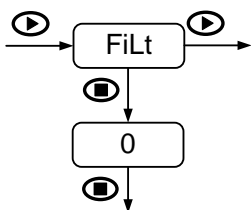

WEIGHTED AVERAGE FILTER:

FiLt: 0 to 9 configurable



Value	Fc (Hz)	Value	Fc (Hz)
0	--	5	2.2
1	7.3	6	1.6
2	5.1	7	1.1
3	3.8	8	0.5
4	2.9	9	0.2

Temperature input

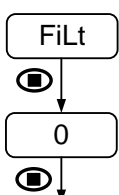

When programmed input type is temperature, for thermocouple and Pt100 or Pt1000 sensor, the only parameter to configure is the filter and its configuration is done in the same way as described for process input.

Display scaling is not available for this input type, the unit then will assume a fixed calibrated range depending on sensor type and previously configured units resolution.

Potentiometer input

When programmed input type is potentiometer, "tEAC" is the only method available to perform display scaling.

In this case, it must be assured first that potentiometer is connected properly and that it is not subjected to any external voltage.

After pressing **ENTER** key, the instrument analyzes connected potentiometer to internally determine both maximum and minimum resistive values. Once this calculation have finished, display shows "dSP1".

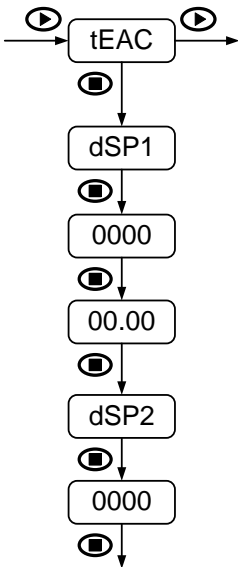

FIRST POINT DISPLAY VALUE:

dSP1: Display value indication.

0000: Value entering in counts within available model display range.

(potentiometer cursor must correspond to process first point).

DECIMAL POINT:

00.00: Setting of decimal point position.

(Decimal point can be located in any position, and will be the same for Display 1 and Display 2. This position remains fixed for all configuration steps and also for **RUN** mode).

SECOND POINT DISPLAY VALUE:

dSP2: Display value indication.

0000: Value entering in counts within available model display range.

(potentiometer cursor must correspond to process second point).

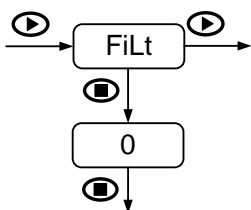

WEIGHTED AVERAGE FILTER:

FiLt: 0 to 9 configurable.



Value	Fc (Hz)	Value	Fc (Hz)
0	--	5	2.2
1	7.3	6	1.6
2	5.1	7	1.1
3	3.8	8	0.5
4	2.9	9	0.2

Resistance input

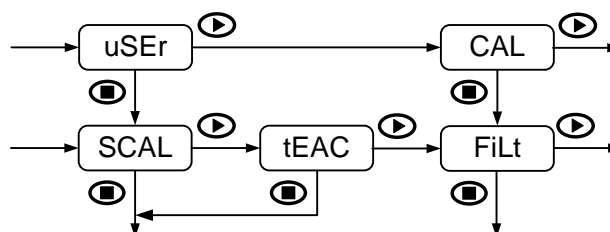

When programmed input type is resistance, display scaling ("uSEr") and also working as a fixed calibrated range ("CAL") depending on the resistance range previously configured are available.

Display scaling is possible through frontal keys ("SCAL") and through real input signal ("tEAC") as described for process input. If the fixed calibrated range option "CAL" is selected, the programming routine goes directly to the filter configuration ("FiLt") with no option to return to scaling configuration.

Filter configuration is done in the same way as described for process input.

SETPOINTS CONFIGURATION

Setpoints configuration

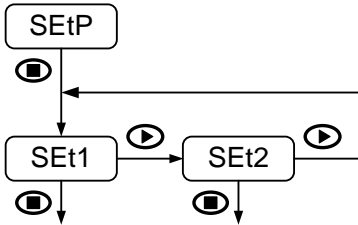

The third menu "SEtP" only appears when two relays output card is installed. For further details on function modes please refer to the corresponding **OUTPUT OPTION** part later on this manual.

Programming steps are equal for both relays on each "SEt1" and "SEt2" submenus. The parameters to be configured are the following:

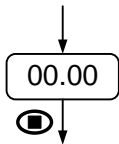

SETPOINT VALUE:

00.00: Value entering in counts within available model display range. (Is not possible to change decimal point position, which is the previously defined in display configuration menu).

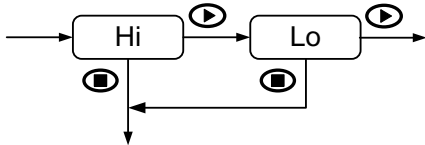

ACTIVATING MODE:

Hi: High level relay activation.
Lo: Low level relay activation.

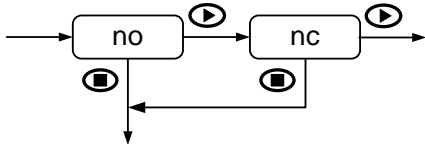

RESTING CONTACTS STATE:

no: Normally open contact.
nc: Normally closed contact.

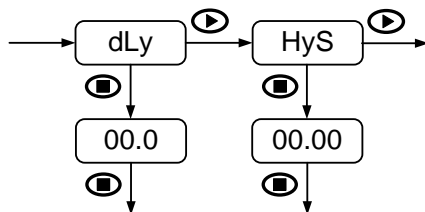

TIME DELAY AND HYSTERESIS:

dLy: Programmable delay from **0** to **99.9s**.
HyS: Hysteresis in counts within available model display range.

If 2RE output option card is uninstalled, the instrument keeps setpoints last configuration in memory, though it can not be visualized.

Thanks to this feature there will be no need to reconfigure relays setting when 2RE output option is again installed if the same configuration is required.

AVAILABLE KEYBOARD FUNCTIONS

In addition to already known functions used to browse through the configuration menus and submenus, introduce and/or modify existing values and parameters, the instrument provides some more added functions.

MAX/MIN and RESET functions

This device detects and stores in memory maximum and minimum values reached by the input signal. These values are kept in memory although power supply is disconnected. When pressing repeatedly **SHIFT** key, **MAX/MIN** function shows saved maximum and minimum values in display since last **RESET** function activation.

In order to differentiate these values indication from a mode **RUN** indication, decimal point blinks during the time these values are shown. The unit automatically switches back to **RUN** mode after 15 seconds have elapsed since the last key press.

First **SHIFT** key pressing shows "**MAH**" in display followed by the maximum value, a second pressing now shows "**Min**" followed by the minimum value and finally, a third pressing shows "**run**" to back again in an instant to **RUN** mode.

RESET function activates when visualizing maximum or minimum values **SHIFT** key is pressed for at least 3 seconds. If maximum is the displayed value, current input signal value will replace the previous maximum saved value. In the same way, current input signal will replace saved minimum value while is the minimum the displayed value.

Direct access to setpoints value

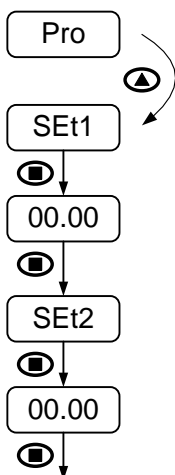

If 2RE output option is installed, it is possible to access to setpoints value configuration without having to enter main menu.

To access this submenu, from **RUN** mode and after **ENTER** key is pressed, simply press **UP** key while "**Pro**" is displayed.

FIRST SETPOINT VALUE:

SEt1: Setpoint 1 value indication.

00.00: Value entering in counts within available model display range.

SECOND SETPOINT VALUE:

SEt2: Setpoint 2 value indication.

00.00: Value entering in counts within available model display range.

Return to default configuration

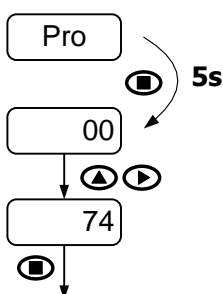

To access this menu from **RUN** mode, press **ENTER** key and while display shows "**Pro**" press again **ENTER** for at least 3 seconds.

Display shows now "**00**" and '**74**' code must be introduced through **SHIFT** and **UP** keys.

Finally press **ENTER** to validate configuration and back to **RUN** mode.

Access to lock-out configuration menu

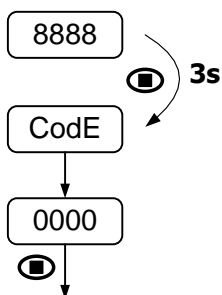

To access this menu from **RUN** mode, press **ENTER** key for at least 3 seconds.

Display shows now "**CodE**" and then "**0000**". Desired security code must be introduced through **SHIFT** and **UP** keys (by default this code is **0000**).

Finally press **ENTER** to begin with lock-out level configuration. If entered security code is wrong, the instrument will go back to **RUN** mode.

CONFIGURATION LOCK-OUT

Lock-out menu

In order to prevent accidental or undesirable modifications of instrument parameters, a selective or total configuration lock-out is available. By default the unit is delivered unlocked, giving access to all programming levels. Once in this menu, the first option will be to choose between lock-out level setting ("LiSt") or security access code changing ("CHAn").

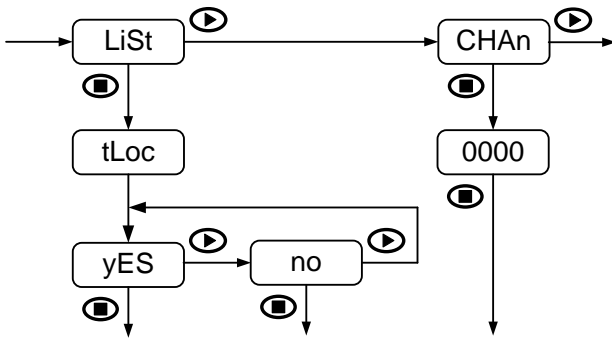

If "LiSt" option is selected, display will show momentarily "tLoc". Total configuration lock-out is activated by selecting "yES", then routine directly jumps to MAX/MIN lock-out configuration before the unit goes back to RUN mode. **When total lock-out is set, no data can be entered or modified**, although it will still be possible to visualize all programmed parameters. Under these conditions when entering main menu, initial indication will be "dAtA" instead of "Pro".

On the other hand, when "no" option is selected, routine move on to next step to configure a partial lock-out. **When a partial lock-out is set, only non-locked data can be entered or modified**. Under these conditions when entering main menu, initial indication will be "Pro".

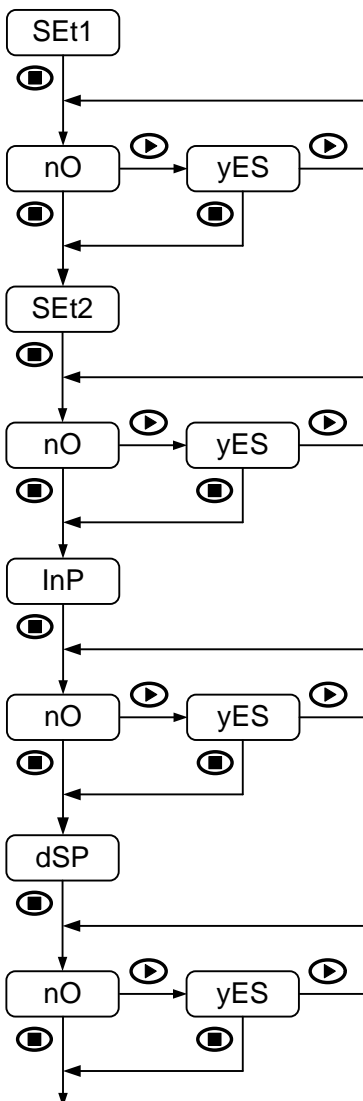

The following configuration access can be locked-out:

- Setpoint 1 configuration (SEt1)
- Setpoint 2 configuration (SEt2)
- Input configuration (InP)
- Display configuration (dSP)
- SHIFT key configuration for MAX/MIN function (MAH)
(New added feature from P2.02 soft version).

In each case lock-out is activated by selecting "yES" option and deactivated by selecting "nO".

Setpoints 1 and 2 configuration lock-out is available only when 2RE output is installed.

If 2RE output option card is uninstalled, the instrument keeps setpoints last configuration in memory, though it can not be visualized. There will be no need to reconfigure setpoints lock-out when 2RE output option is again installed if the same configuration is required.

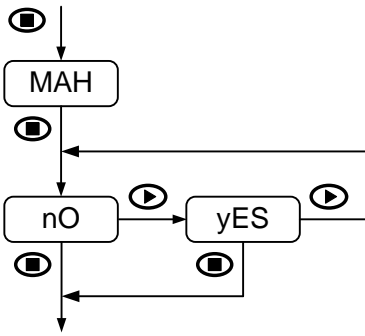

Now it is possible to configure SHIFT key lock-out for MAX/MIN function in the same way as previous configurations.

When lock-out is enabled (selecting "yES") it is not possible to visualize maximum or minimum values by pressing SHIFT key, although instrument internally continues detecting and saving new extreme values reached by input signal.

Once the instrument programming is completed, if there are parameters that are going to be frequently changed, a partial lock-out is recommended. A total lock-out is recommended when configuration parameters will be constant for a long time.

Changing default security code and keep new one in a safe place is also strongly recommended.

OUTPUT OPTION

Description

2RE output option allows JR-P and JR20-P models to perform control operations and limit values treatment via ON/OFF logic outputs. It is supplied as an independent card that is connected to main board without any additional operation since internal software recognizes it once it is installed. There is no need to read the manual since all information required is contained in this user manual.

Function modes description

Alarms are independent, they become activate when display value reach setpoint level programmed by the user. For a correct configuration it will be necessary to define function mode, as well.

HI/LO mode activation

In **HI** mode, output activates when display value goes above setpoint level, whereas in **LO** mode, output activates when display value falls below setpoint level.

Time delay

Both output actions can be deferred by a configurable time delay from 0 up to 99.9 seconds.

Time delay activation starts when display value reach each setpoint **SET** either increasingly or decreasingly, obtaining the **dly** delay in output activation/deactivation as right figure shows.

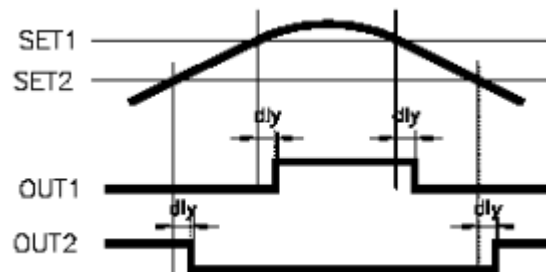

Time delay for OUT1 (**HI** mode) and for OUT2 (**LO** mode)

Asymmetrical hysteresis

Both output actions can be deferred by a hysteresis level which is configurable in counts within full available display. Decimal point position is the previously defined in display configuration menu.

Asymmetrical hysteresis action only starts in the output deactivation edge, obtaining as a result the **'hys-1'** delay as indicated on the right figure.

Note that outputs activation is not affected by hysteresis and they activate in each case just when setpoint **SET** is reached by display.

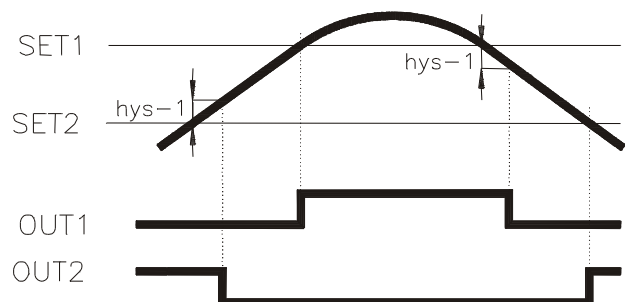

Hysteresis delay for OUT1 (**HI** mode) and for OUT2 (**LO** mode)

Installation

To physically install the output option, the electronics assembly should be first lifted out from the case. Use a screwdriver or similar to slightly press both side tabs until the rear case is released. Then broke the junctions from the corresponding polycarbonate cover in order to obtain the required orifice in the case. This orifice will allow 2RE connectors come out through instrument rear part once it is installed.

Install 2RE option on the indicated location pushing slightly down until both connectors get perfectly together. For best installation, it is recommended to solder this card to the main circuit making use of the copper pads on both sides of its insertion pin and those surrounding the circuit hole where it is inserted in.

Once 2RE is installed, carefully put the circuitry again inside the case verifying that circuits slide properly without much effort through rear case internal guides.

Each output card is supplied with an adhesive label that indicates wiring connections. To help identifying terminals, this label should be placed in the upper side of the unit case. Besides its own connections, there are other output options indications for other outputs that can be installed in other model indicators.

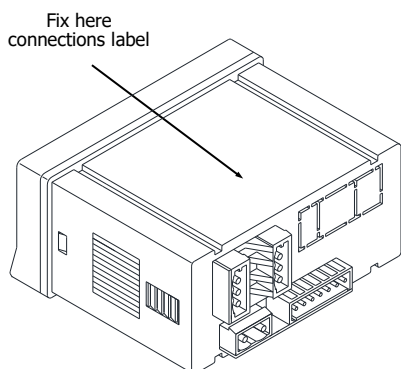
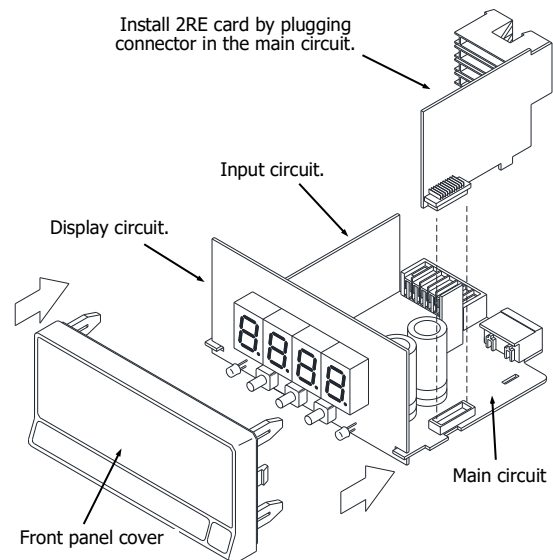
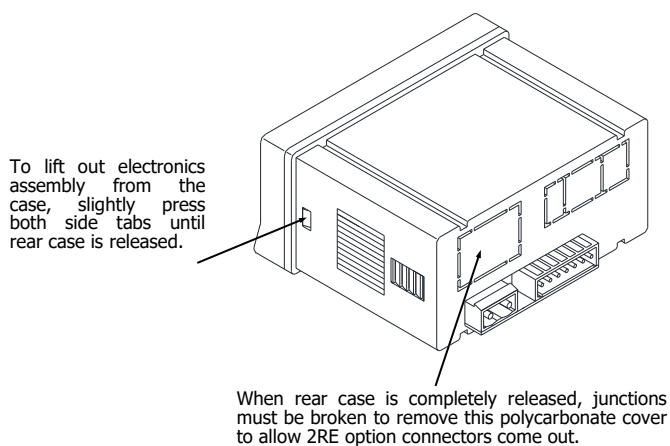

Once 2RE is installed and instrument is again inside the case, 2RE connectors should come out through the obtained orifice as this figure shows.



WARNING: Disconnect all power and rest of input signals connected to the indicator before installing or extracting the output option card.

SPECIFICATIONS

Technical specifications

SPECIAL FUNCTIONS

Return to factory configuration.
Software configuration lock-out.

PRECISION

Temperature coefficient 100 ppm/°C
Warm-up time 5 minutes
Specifications range 23°C±5°C

POWER SUPPLY AND FUSES (DIN 41661) (not included)

JR-P: 20-265 V AC 50/60 Hz and 11-265 V DC.. F 3A/ 250V
JR20-P: 20-265 V AC 50/60 Hz and 11-265 V DC.. F 3A/ 250V
Power consumption (both models) 3W
Sensor excitation . 24V±3V DC@30mA / 10V@30mA (stabilized)

CONVERSION

Technique Sigma-Delta
Resolution 16 bits
Conversion rate 20/s

DISPLAY

Range:
JR-P 9999 ÷ 9999, 14mm RED LED
JR20-P -1999 ÷ 9999, 20mm RED LED
Decimal point Configurable
LEDs 2 for setpoints state indication
Display refresh rate 50ms
Display/input overrange indication "OuE", "OuE"
Sensor failure indication "OuE"

ENVIRONMENTAL CONDITIONS

Operating temperature -10°C ÷ +60°C
Storage temperature -25°C ÷ +85°C
Relative humidity (non-condensing) <95% @ 40°C
Maximum altitude 2000m
Frontal protection degree IP65

INPUT SIGNAL

Configuration Differential asymmetrical

PROCESS

±10V and ±200V input impedance 2MΩ
±20mA input impedance <20Ω
Maximum input signal (±10V range) ±11V
Maximum input signal (±20mA range) ±22mA
EMI max. Influence (±10V) ±7mV
EMI max. Influence (±200V) ±60mV
EMI max. Influence (±20mA) ±6μA

POTENTIOMETER

Max EMI max. Influence 0.4mA ±0.07%F.S.

RANGE	RESOLUTION	ACCURACY
±10V	1mV	±(0.1%rdg + 6mV)
±200V	20mV	±(0.1%rdg + 0.1V)
±20mA	2μA	±(0.1%rdg + 15μA)

RANGE	RESOLUTION	ACCURACY
100Ω-100kΩ	0.01%F.S.	±(0.1%rdg + 0.05%F.S.)

TEMPERATURE

Pt100 measurement current 1mA
Pt1000 measurement current 100μA
Pt100 maximum wire resistance 40Ω (balanced)
Pt100/Pt1000 linearization IEC 60751
Pt100/Pt1000 α coefficient 0.00385
Thermocouple cold junction compensation range ... -10°C÷+60°C
EMI max. Influence (Pt100) ±1.3°C
EMI max. Influence (Pt1000) ±0.6°C
EMI max. Influence (Thermocouple) ±6°C

Pt100 (3 wires)		
RANGE	RESOLUTION	ACCURACY
-200.0°C to +800.0°C	0.1°C	±(0.15%rdg + 0.5°C)
-200°C to +800°C	1°C	±(1%rdg + 0.5°C)*

*Only for temperatures t< -50°C/-58°F

Pt1000 (2 wires)		
RANGE	RESOLUTION	ACCURACY
-200.0°C to +800.0°C	0.1°C	±(0.15%rdg + 0.5°C)
-200°C to +800°C	1°C	±(1%rdg + 0.5°C)*

*Only for temperatures t< -50°C/-58°F

THERMOCOUPLE J		
RANGE	RESOLUTION	ACCURACY
-150.0°C to +999.9°C	0.1°C	±(0.1%rdg + 0.6°C)
-150°C to +1100°C	1°C	

THERMOCOUPLE K		
RANGE	RESOLUTION	ACCURACY
-150.0°C to +999.9°C	0.1°C	±(0.1%rdg + 0.6°C)
-150°C to +1200°C	1°C	

THERMOCOUPLE T		
RANGE	RESOLUTION	ACCURACY
-150.0°C to +400.0°C	0.1°C	±(0.2%rdg + 0.8°C)
-150°C to +400°C	1°C	

THERMOCOUPLE N		
RANGE	RESOLUTION	ACCURACY
-150.0°C to +999.9°C	0.1°C	±(0.1%rdg + 0.6°C)
-150°C to +1300°C	1°C	

RESISTANCE

999.9Ω range max. measurement current 2.3mA
 9999Ω range max. measurement current 230μA
 50.00kΩ range max. measurement current 23μA
 EMI max. Influence (999.9Ω) ±0.7Ω
 EMI max. Influence (9999Ω) ±2Ω
 EMI max. Influence (50.00kΩ) ±20Ω

RANGE	RESOLUTION	ACCURACY
999.9Ω	0.1Ω	±(0.1%rdg + 0.7Ω)
9999Ω	1Ω	±(0.1%rdg + 6Ω)
50.00kΩ	10Ω	±(0.1%rdg + 35Ω)

FILTER

Cutoff frequency (-3dB) 7.3Hz to 0.2Hz
 Slope 20dB/Dec.

DIMENSIONS

Dimensions 96 x 48 x 60 mm (1/8 DIN).
 Panel cutout 92 x 45 mm.
 Weight 150g.
 Case material UL 94 V-0 polycarbonate.

2RE OPTION

Maximum switching current (resistive load) 8A
 Maximum switching power 2000VA / 192W
 Maximum switching voltage 400VAC / 125VDC
 Contact rating 8A @ 250VAC / 24VDC
 Contact resistance ≤ 100mΩ at 6V DC @ 1A
 Contact type SPDT
 Operate time ≤ 10ms

NOTE:

In case that the outputs are used to drive inductive loads, it is recommended to add an RC network between the coil terminals (preferably) or between the relay contacts, to limit electromagnetic effects and to extend contacts life.

NOTES:

INSTRUMENT CONFIGURATION

Use the following template for the annotation of configured parameters in your instrument for later consulting or data recover.

INPUT:

TYPE: _____
 RANGE: _____

DISPLAY:

CONFIG. MODE: SCAL TEACH CAL
 INPUT 1: _____
 DISPLAY 1: _____
 INPUT 2: _____
 DISPLAY 2: _____
 FILTER (0 ÷ 9): _____

SETPOINTS:

SET1:
 MODE: _____
 DLY: _____
 HYS: _____ no nc
 SET2:
 MODE: _____
 DLY: _____
 HYS: _____ no nc

LOCK-OUT:

ACCESS CODE: _____

