

Description

The limit switch box is for direct mounting on pneumatic actuators IA050-IA600. The mounting brackets can be used for all standard NAMUR (VDI/VDE3845) top mounting hole spacing 80x30mm and 130x30mm and standard NAMUR shaft heights 20, 30, 40 and 50mm.

Product features

- Housing cover Polycarbonate clear, UV resistant, self extinguishing rate V0
- Housing base PPE (Polyphenyl Ether) black, self extinguishing rate V0, IP65
- Limit switches 1x ON, 1x OFF
- Cam with 2 independent adjustable cams
- Cable gland M20 x 1,5



Dimensions

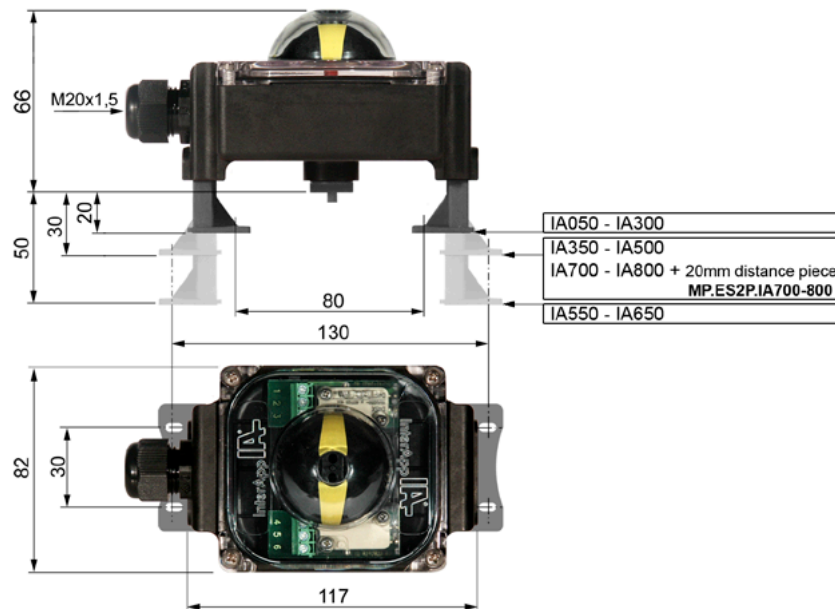

ES2.P01H

Box with mechanical microswitches
max. 5A@250V~ - 3A@24=
min. 50mA@250V~ - 50mA@24=
IP65, T = -15°C80°C

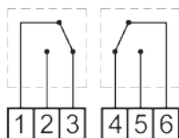

ES2.P03H

with gold contacts
max. 3A@250V~ - 1A@24=
min. 5mA@250V~ - 1mA@24=

ES2.P70L

Box with proximity switches, NAMUR
P+F NJ2 V3 N EEx ia IIC T6
0-8V=, 3mA, 2-wire
IP65, T = -15°C80°C

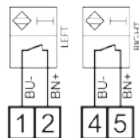

ES2.P73H

Box with proximity switches, PNP
P+F NBB2 V3 E2
10-30V=, 200mA, 3-wire
IP65, T = -15°C70°C

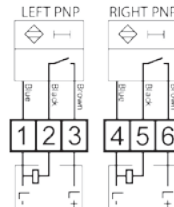

ES2.P75H

Box with proximity switches
IFM IS 5026
5-36V=, 4-200mA, 2-wire NC/NO
IP65, T = -15°C80°C

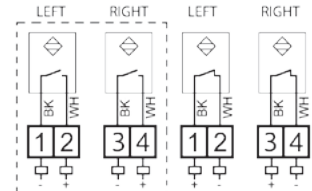

ES2.A/B/F/S - Limit switch box (metal)

Description

The limit switch box is for direct mounting on pneumatic actuators IA050-IA800. The mounting brackets can be used for all standard NAMUR (VDI/VDE3845) top mounting hole spacing 80x30mm and 130x30mm and standard NAMUR shaft heights 20, 30, 40 and 50mm.

Product features

- Housing ES2.B/F/A : Aluminium
ES2.S : Stainless steel AISI316 (CF8M)
- Limit switches 1x ON, 1x OFF
- Cam with 2 independent adjustable cams
- Weather proof, Temperature IP67, -20°C ... +80°C or maximum temperature of the installed limit switch

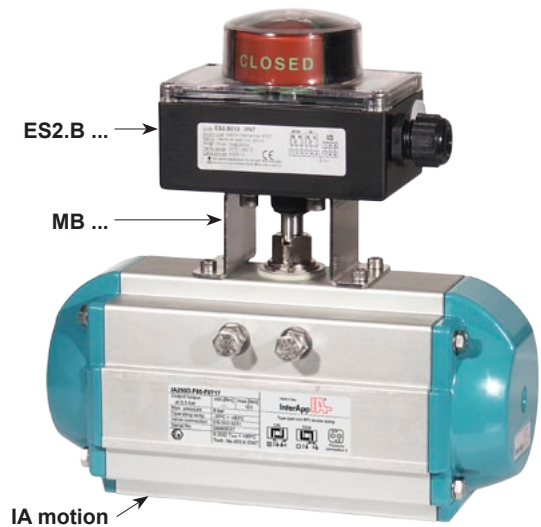

Dimensions

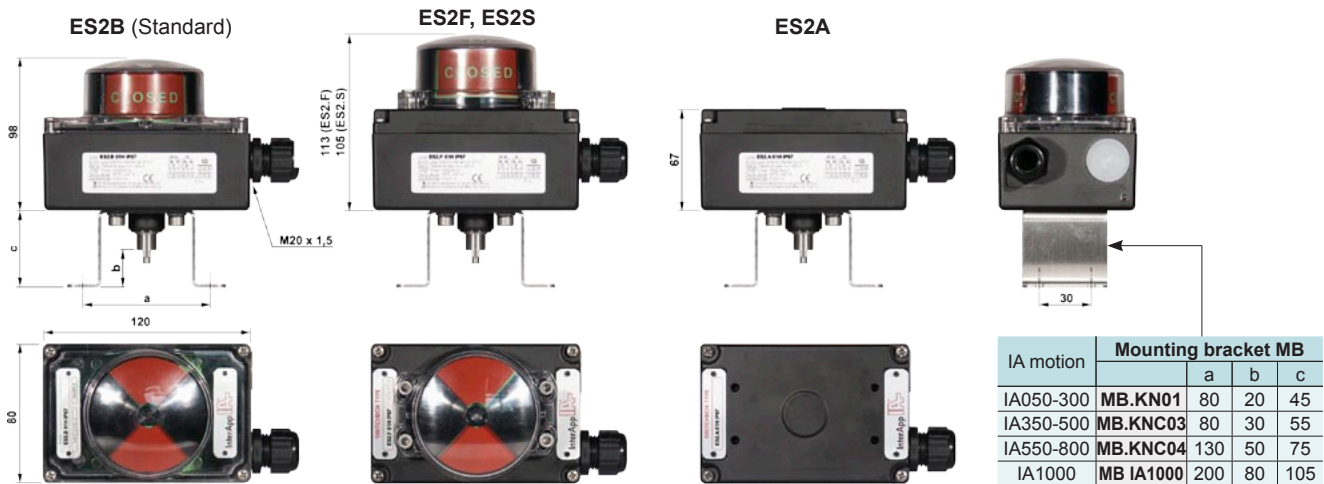

Limit switch types ES2.B .., ES2.F .., ES2.A .., ES2.S ..		
01	electromech SPDT silver plated contacts	max. 5A@250VAC - 3A@24VDC, min 50mA@250VAC - 50mA@24VDC
02	electromech SPDT gold plated contacts hermetically sealed	max. 3A@250VAC - 1A@24VDC, min 5mA@250VAC - 1mA@24VDC
03	electromech SPDT gold plated contacts	max. 3A@250VAC - 1A@24VDC, min 5mA@250VAC - 1mA@24VDC
17	electromech DSPDT gold plated contacts hermetically sealed	max 0,1A@250VAC - 0,1A@24VDC, min 1mA@24VDC
18	electromech DPDT silver plated contacts hermetically sealed	max 2A@250VAC - 2A@24VDC, min 50mA@24VDC
C3	proximity SPST bifurcated inert gas hermetically sealed	max. 1,5A@120VAC - 0,5A@24VDC (resistive / inductive)
C4	proximity SPDT inert gas hermetically sealed	max. 1A@120VAC - 1A@24VDC - max. 25Watt
32	proximity NO P+F NBN4 12GM40 Z0	2 wire amplified 5-60VDC, 2 -100mA
73	proximity PNP NO P+F NBB2 V3 E2	3 wire amplified 10-30VDC, 100mA
75	proximity NO / NC programmable IFM IS5026	2 wire amplified 5-36VDC, 200mA
83	proximity NO P+F NBB3-V3-Z4	2 wire amplified 5-60VDC, 100mA
91	4-20mA Transmitter	10-30VDC