

Temposonics®

Magnetostrictive, Absolute, Non-contact
Linear-Position Sensors



E-Series Model EH Analog and Start/Stop Outputs

Document Part Number:
551250 Revision B

Data Sheet



Model EH rod-style position sensor
Stroke Length: 50 mm to 2500 mm (2 in. to 100 in.)

FEATURES

- Linear, Absolute Measurement
- Non-Contact Sensing Technology
- Linearity Deviation Less Than 0.02% F.S.
- Repeatability Within 0.005% F.S.
- Two Outputs Available:
 - Analog (Voltage/Current) Forward or Reverse Acting
 - Start/Stop Output
- Simple Sensor Parameter Upload (for Start/Stop)
- Stroke Length Range: 50 mm to 2500 mm (or 2 in. to 100 in.)
- Completely-Sealed Stainless Steel For IP69K Ingress Protection
- EMI Shielded and CE Certified
- Also with Stainless Steel 1.4404 / AISI 316L available

BENEFITS

- Compact Stainless Steel Position Sensor, Designed For Use In Hydraulic Cylinders
 - Standard 10 mm dia. Sensor Rod For Typical Applications
 - Optional 7 mm dia. Sensor Rod For Use In Small Bore Cylinders
- Simultaneous Multi-position Measurements
- Over Voltage Protection to 36 Vdc and Polarity Protection up to -30 Vdc

APPLICATIONS

- Clevis Mounted or Space Limited Cylinder Applications
- Harsh Industrial Conditions
- High-Pressure Washdown
- Gates and Valve Control

TYPICAL INDUSTRIES

- Fluid Power
- Factory Automation
- Steel Mills
- Material Handling and Packaging
- Water Management

Time-based Magnetostrictive position sensing principle

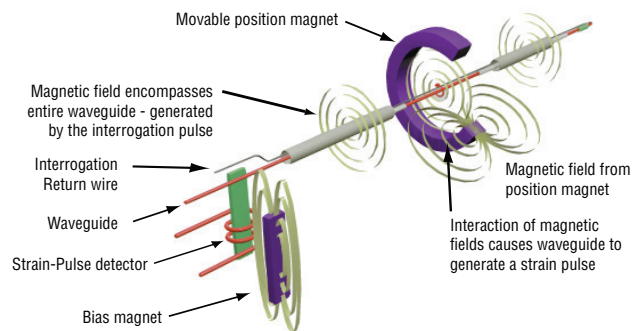

Benefits of Magnetostriction

Temposonics linear-position sensors use the time-based magnetostrictive position sensing principle developed by MTS. Within the sensing element, a sonic-strain pulse is induced in a specially designed magnetostrictive waveguide by the momentary interaction of two magnetic fields. One field comes from a movable permanent magnet that passes along the outside of the sensor. The other field comes from an “interrogation” current pulse applied along the waveguide. The resulting strain pulse travels at sonic speed along the waveguide and is detected at the head of the sensing element.

The position of the magnet is determined with high precision and speed by accurately measuring the elapsed time between the application of the interrogation pulse and the arrival of the resulting strain pulse with a high-speed counter. The elapsed time measurement is directly proportional to the position of the permanent magnet and is an absolute value. Therefore, the sensor's output signal corresponds to absolute position, instead of incremental, and never requires recalibration or re-homing after a power loss. Absolute, non-contact sensing eliminates wear, and guarantees the best durability and output repeatability.

All specifications are subject to change. Contact MTS for specifications and engineering drawings that are critical to your application. Drawings contained in this document are for reference only. Go to <http://www.mtssensors.com> for the latest product documentation and related media.

E-Series Model EH Sensor, Analog and Start/Stop Outputs

Product Overview/Specifications

Product overview

MTS Sensors continues to establish new performance standards for low-cost, fully-industrial, durable position sensors using the widely preferred magnetostrictive technology. This principle for accurate and non-contact measurement of linear-position sensing was developed 30 years ago by MTS and is used with outstanding success in a large variety of industrial applications. The Temposonics model EH sensor provides as much performance as you need for your application - you benefit from the advantages of magnetostrictive position measurement at optimum costs.

The Temposonics® Model EH sensor features a pressure resistant sensor rod for direct stroke measurement inside hydraulic cylinders. With its mini-mized sensor head and either a 7 mm or 10 mm rod, it is the ideal solution when space is critical. For long strokes, the model EH is available with measuring ranges up to 2500 mm (or 100 in.).

The model EH sensor offers completely sealed stainless-steel housing for long life position measurement for rugged environments. When installed with the appropriate mating connector and cable, it features protection up to IP69K and is suitable for high-pressure washdown applications.

Product specifications

Parameters	Specifications	Parameters	Specifications
OUTPUT		ENVIRONMENTAL	
Measured output variable:	Position	Operating conditions:	Operating temperature: -40 °C (-40 °F) to 75 °C (167 °F) Relative humidity: 90% no condensation Ingress protection: IP69K <i>(when appropriate mating connector is correctly fitted)</i>
Resolution:	Analog: Infinite (restricted by output ripple) Start/Stop: 0.1, 0.01 and 0.005 mm (controller dependent)	EMC test:	Electromagnetic emission: EN 61000-6-4 Electromagnetic susceptibility: EN 61000-6-2 The sensor meets the EC directive requirements and is marked with CE.
Linearity deviation:	< ± 0.02% full stroke (minimum ± 60 µm)	Shock rating:	100 g (single hit)/ IEC standard EN 60068-2-27
Repeatability:	< ± 0.005% full stroke (minimum ± 20 µm)	Vibration rating:	15 g/10 to 2000 Hz, IEC standard EN 60068-2-6 (resonance frequencies excluded)
Outputs:	Analog (voltage or current) Voltage: 0 to 10 Vdc or 10 to 0 Vdc or Two outputs: 0 to 10 Vdc and/or 10 to 0 Vdc (controller input resistance $R_L \geq 5k \text{ Ohm}$) Current: 4 to 20 mA or 20 to 4 mA or Two outputs: 4 to 20 mA or 20 to 4 mA (controller input resistance $R_L \leq 500 \text{ Ohm}$)	WIRING	
	Digital-pulse (Start/Stop): RS-422 differential signal Serial parameter upload available for: Measuring range, offset, gradient, status and manufacturer number	Connection types:	Analog output: 5-pin (M12) male integral connector Start/Stop output: 8-pin (M12) male integral connector
Stroke length:	Range: 50 mm to 2500 mm (or 2 to 100 in.)	ROD-STYLE SENSOR (MODEL EH)	
ELECTRONICS		Sensor housing:	Stainless Steel 1.4305 / AISI 303; Stainless Steel 1.4404 / AISI 316L
Operating voltage:	+24 Vdc nominal: -15% or +20% Polarity protection: up to -30 Vdc Over voltage protection: up to 36 Vdc Current drain: <i>Analog:</i> 50 to 140 mA <i>Start/Stop:</i> 50 to 100 mA <i>(Stroke length dependent)</i> Dielectric withstand voltage: 500 Vdc (DC ground to machine ground)	Sensor rod:	Stainless Steel 1.4301 / AISI 304; Stainless Steel 1.4404 / AISI 316L for Ø 10 mm rod only
		Operating pressure:	7 mm Rod: 300 bar static, 450 bar peak (4350 psi static, 6500 psi peak) 10 mm Rod: 350 bar static, 530 bar peak (5000 psi static, 7700 psi peak)
		Mounting:	Any orientation. Threaded flange M18 x 1.5 or 3/4 - 16 UNF-3A
		Typical mounting torque:	45 N-m (33 ft. - lbs.)
		Magnet types:	Ring magnet, open-ring magnet or magnet float

Outputs

ANALOG (VOLTAGE/CURRENT) OUTPUTS

Analog outputs include voltage (0 to 10 Vdc forward or reverse acting), and current (4 to 20 mA forward or reverse acting). Since the outputs are direct, no signal conditioning electronics are needed when interfacing with controllers or meters (see 'Figure 1').

Analog output ranges:

- 0 to 10 Vdc
- 10 to 0 Vdc
- 0 to 10 Vdc and 10 to 0 Vdc
- 4 to 20 mA
- 20 to 4 mA

DIGITAL (START/STOP) OUTPUTS

The Temposonics E-Series Model EH Start/Stop output sensor requires a start signal from a controller or interface module to initiate the measurement cycle. The sensor generates a stop signal at the end of the measurement cycle that is used to stop the controller's counter clock.

The elapsed time between the Start and Stop signals is directly proportional to the magnet's position along the active stroke length. The controller can calculate the absolute position of the magnet from the time value and the sensor's unique gradient value (inverse of the speed for the sonic pulse traveling in the sensor's waveguide). (see 'Figure 2').

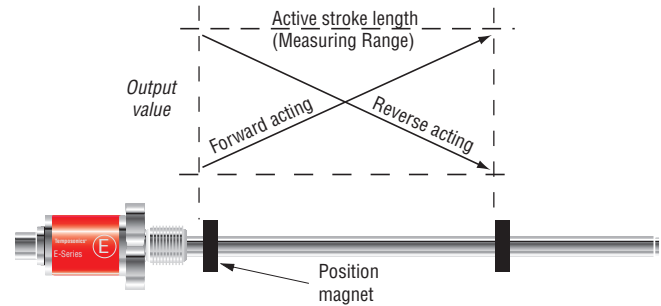

Figure 1. Analog Output signals

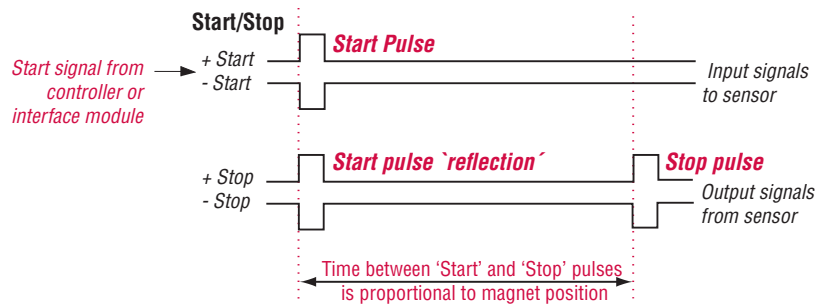

Figure 2. Start/Stop output signals (RS-422 differential pairs)

Dual magnet outputs

MEASUREMENT OPTIONS

E-Series sensors provide options for simultaneous multi-position measurements by using more than one magnet per sensor. When using Start/Stop sensor output the ability to process multiple magnets depends on the capability of the controller or interface module that is used. When using analog type outputs (voltage or current) the sensor is limited to a maximum of two magnets.

For analog output types the options for single-magnet or dual-magnets is specified in the sensor model number when ordered. For single-magnet sensors the sensor's full active stroke length is utilized by the one magnet. For example when using forward-acting outputs, the output is 0% of its value when the magnet is at the null position (start of stroke) and 100% of its value when at the edge of the dead zone (end of stroke), (see 'Figure 3').

However, for dual-magnet sensors the sensor's active stroke length must be shared by the two magnets, and a separation \geq to 75 mm (3 in.) must be maintained between the two magnets (front side of the first magnet to front side of the second magnet). This minimum distance between magnets is needed to maintain proper sensor output. Therefore, for the second magnet the start of stroke (0% output) is set at 75 mm away from the sensor's null position. Likewise, for the first magnet the end of stroke (100% output) is now set 75 mm away from the edge of the dead zone (see 'Figure 3').

The result of using the dual-magnet E-Series options is that the stroke length available for each magnet is 75 mm less (or 3 inches less when specifying stroke length in inches) than the sensor's full active stroke length as indicated in the model number.

When ordering the single-magnet E-Series sensor the minimum stroke length available is 50 mm or 2 inches. However when ordering dual magnet E-Series sensors the minimum stroke length available is 125 mm (i.e. 50 mm minimum, plus 75 mm for the minimum distance between magnets). Likewise, when specifying stroke length in inches the minimum stroke length available is 5 inches (i.e. 2 inch minimum, plus 3 inches for the minimum distance between magnets).

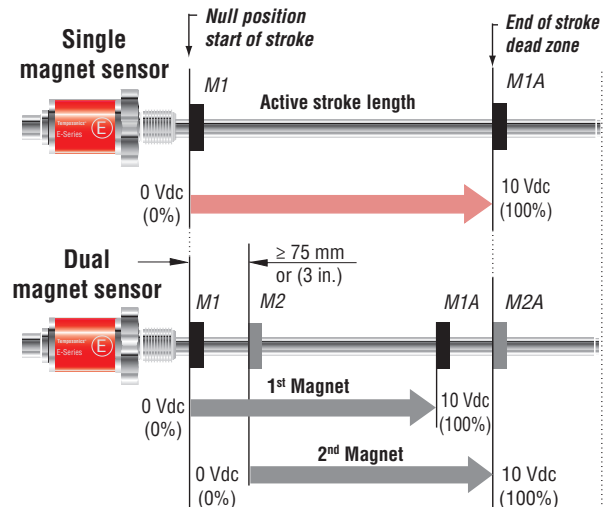

Figure 3. Single and dual magnet measurements

E-Series Model EH Sensor, Analog and Start/Stop Outputs Sensor Communications and Dimension References

Communication

SENSOR PARAMETER UPLOAD FEATURE

For applications using smart sensor interfaces, the Model EH sensor with Start/Stop output (*Option R3*) comes with the ability to perform sensor parameter uploads. This feature replaces the task of entering sensor data manually, saving time and preventing possible entry errors during start-up or for system maintenance.

Note: Start/Stop output (option R3)

When the sensor parameter upload feature is not activated the Start/Stop output (Option **R3**) remains fully compatible with the Start/Stop output (Option **R0**) used in the previous generation E-Series sensor family.

The upload feature supports the following sensor parameters:

- Measuring range
- Offset
- Gradient - (Shown as speed of the sonic-strain pulse (m/s) or inverse speed (µs/in.)
- Status
- Manufacturer number

The sensor's specific parameters can be retrieved by the controller and interface module at any time, via the sensor's Start/Stop signal lines.

The sensor parameter upload feature requires a customer supplied RS-422 interface. The data format is serial, 4800 Baud, 8-bit data length. Please contact the factory for additional parameter upload protocol details.

Sensor dimension references

Drawings are for reference only, contact applications engineering for tolerance specific information.

The model EH sensor shown in 'Figure 4' can be ordered with flange styles M18 x1.5 or 3/4 -16 UNF-3A and a 7 mm or 10 mm diameter sensor rod. Magnets must be purchased separately; refer to 'Standard magnet Selections (Model EH)' for standard magnet ordering information.

MODEL EH

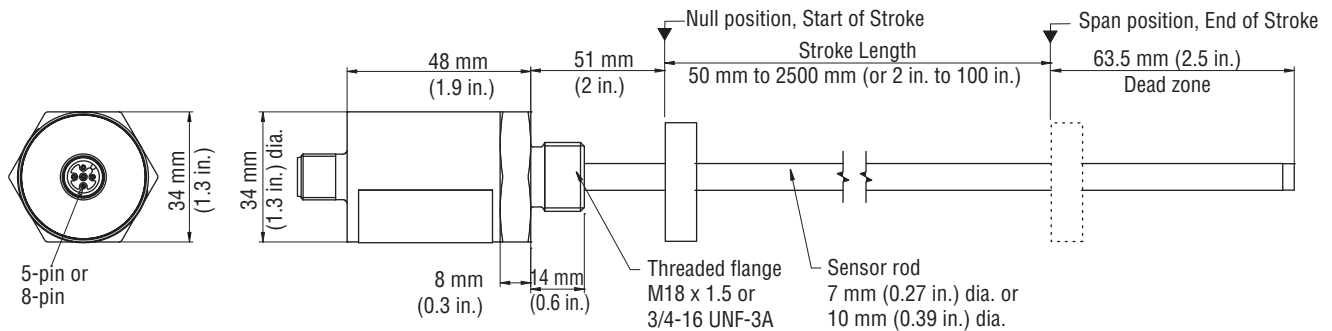



Refer to the model EH sensor ordering information for rod housing and flange types

Figure 4. E-Series model EH sensor dimension reference

Standard magnet options (Model EH)

Magnets must be ordered separately with Model RH position sensors. The standard ring magnet (part number 201542-2) is suitable for most applications.

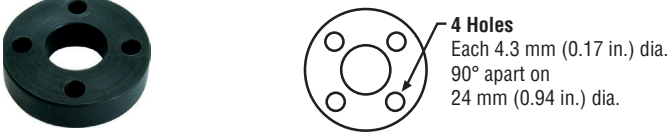
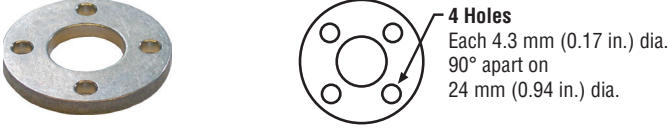
POSITION MAGNET SELECTIONS (Magnet must be ordered separately) (Drawing dimensions are for reference only)

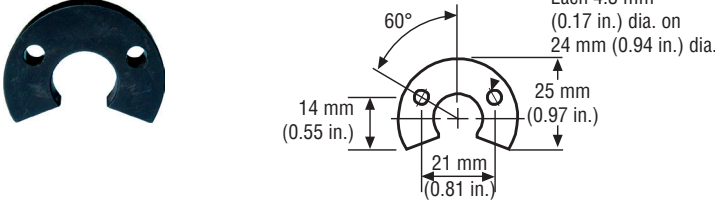
Magnet and magnet dimensions	Description	Part number
 <p>4 Holes Each 4.3 mm (0.17 in.) dia. 90° apart on 24 mm (0.94 in.) dia.</p>	<p>Standard ring magnet I.D.: 13.5 mm (0.53 in.) O.D.: 33 mm (1.3 in.) Thickness: 8 mm (0.3 in.) Operating temperature: - 40 °C to 100 °C</p>	201542-2
 <p>4 Holes Each 4.3 mm (0.17 in.) dia. 90° apart on 24 mm (0.94 in.) dia.</p>	<p>Magnet spacer (Non-ferrous, use with ring magnet Part number: 201542-2) I.D.: 14 mm (0.56 in.) O.D.: 32 mm (1.25 in.) Thickness: 3.2 mm (0.125 in.)</p>	400633
	<p>Ring magnet I.D.: 13.5 mm (0.53 in.) O.D.: 25.4 mm (1 in.) Thickness: 8 mm (0.3 in.) Operating temperature: - 40 °C to 100 °C</p>	400533
 <p>2 Holes Each 4.3 mm (0.17 in.) dia. on 24 mm (0.94 in.) dia. 60° 14 mm (0.55 in.) 25 mm (0.97 in.) 21 mm (0.81 in.)</p>	<p>Open-ring magnet, Style M I.D.: 13.5 mm (0.53 in.) O.D.: 33 mm (1.3 in.) Thickness: 8 mm (0.3 in.) Operating temperature: - 40 °C to 100 °C</p> <p>This magnet may influence the sensor performance specifications for some applications.</p>	251416-2

MAGNET FLOAT SELECTION (Drawing dimensions are for reference only)

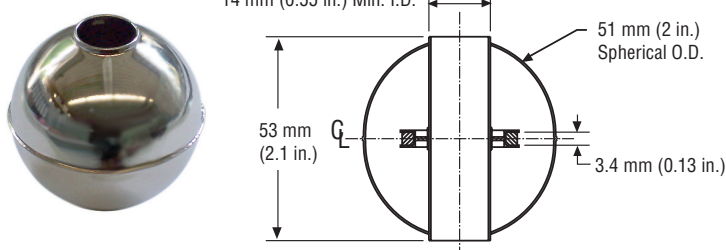
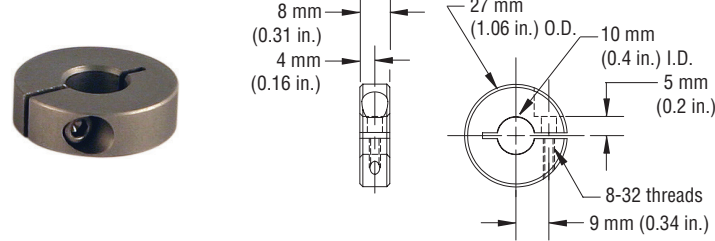
 <p>14 mm (0.55 in.) Min. I.D. 51 mm (2 in.) Spherical O.D. 53 mm (2.1 in.) 3.4 mm (0.13 in.)</p>	<p>Magnet float (Level sensing applications) Specific gravity: 0.70 maximum Pressure: 870 psi maximum</p> <p>(This float is used with rod-style sensors for hydraulic fluid or fresh water applications only). Collar (part no.: 560777) is recommended for end of stroke stops.</p>	251447
 <p>8 mm (0.31 in.) 4 mm (0.16 in.) 27 mm (1.06 in.) O.D. 10 mm (0.4 in.) I.D. 5 mm (0.2 in.) 8-32 threads 9 mm (0.34 in.)</p>	<p>Collar Provides end of stroke stops for magnet float (part no.: 251447)</p>	560777

E-Series Model EH Sensor, Analog and Start/Stop Outputs Mounting Reference, Connections and Wiring

Model EH Rod-Style sensor mounting

MODEL EH SENSOR MOUNTING

The model EH sensor is designed for direct stroke measurement inside prepared hydraulic cylinders. At the head of the sensor, a threaded flange and O-Ring provides for mounting and sealing the sensor into a port opening in the cylinder end cap. The sensor's pressure resistant rod fits into a bore drilled through the center of the piston head and rod assembly. The sensor's position magnet is mounted on the top of the piston head or installed in a shallow counter-bore inside the piston head.

The position magnet requires minimum distances away from ferrous metals to allow proper sensor output. The minimum distance from the front of the magnet to the cylinder end cap is 15 mm (0.6 in.).

The minimum distance from the back of the magnet to the piston head is 3.2 mm (0.125 in.). However, a minimum distance of at least 5 mm (0.197 in.) is preferred for performance margin. The non-ferrous spacer (part no. 400633), provides this minimum distance when used along with the standard ring magnet (part no. 201542-2), as shown in 'Figure 5'.

The magnet is usually secured using non-ferrous fastening material (customer supplied). Screws must be made of nonmagnetic stainless steel or brass. In the event that a ferrous circlip or retaining ring will be used to secure the magnet in a counter-bore then an additional non-ferrous spacer (> or = 3.2 mm) must be placed between the circlip or retaining ring and the front side of the magnet.

The cylinder's design ratings for hydraulic pressure and piston velocity will determine the appropriate size for the bore that is drilled through the center of the piston head and rod assembly. The recommended minimum size for this bore is 10 mm (0.39 in.) when using the 7 mm (0.27 in.) diameter sensor rod.

Likewise, the recommended minimum size of 13 mm (0.51 in.) should be used when installing the 10 mm diameter sensor rod. Some applications using long sensor rods may benefit by adding a bushing (e.g. made of flourelastomer material) to prevent wear on the magnet and sensor rod (customer supplied).

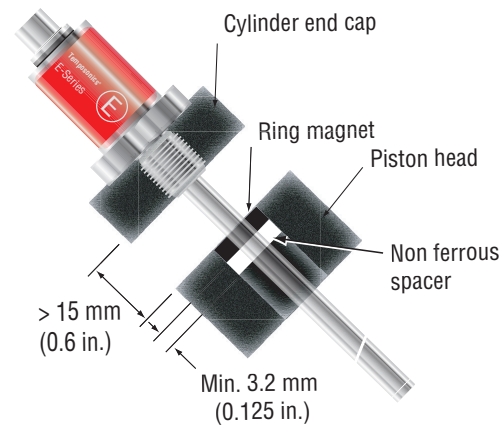

Figure 5. Model EH rod-style mounting

Connections and wiring (Model EH)

SENSOR INTEGRAL CONNECTOR (D34 AND D84) PINOUT/WIRE COLOR CODES

The E-Series Model EH sensor connects directly to a controller or interface module with the standard male, 5-pin or 8-pin integral connector and an extension cable as described in 'Table 1' and 'Table 2'.



Integral D34 connector (male) as viewed from the end of the sensor

Pin no.	Extension cable wire color	Signal/function Analog outputs
1	Brown	+24 Vdc
2	White	Output signal
3	Blue	DC ground (for power return)
4	Black	2nd Output signal (optional)
5	Gray	Ground for signal return

Table 1. Integral D34 sensor connector
(mates with cable connectors 370618 and 370619)



Integral D84 connector (male) as viewed from the end of the sensor

Pin no.	Extension cable wire color	Signal/function Start/Stop outputs
1	White	(+) Start
2	Brown	(-) Start
3	Green	(+) Stop
4	Yellow	(-) Stop
5	Gray	No connection
6	Pink	No connection
7	Blue	+24 Vdc
8	Red	DC Ground (0 Vdc) for power return

Table 2. Integral D84 sensor connector
(mates with cable connectors 370671 and 370672)

E-Series Model EH Sensor, Analog and Start/Stop Outputs Cable Connector Options (D34 and D84)

MATING CABLE CONNECTOR OPTIONS FOR (D34) CONNECTOR TYPES *(Photo and drawing dimensions are for reference only)*

Connector and dimensions	Description	Part number
	<p>Female cable connector, straight exit (Field installable) 5-Pin (D34) Mates with standard male (M12) integral connector Termination: Screw terminals Cable gland: PG9 for 6-8 mm dia. cable Ingress protection: IP67</p>	370677
	<p>Female cable connector, 90° exit (Field installable) 5-Pin (D34) Mates with standard male (M12) integral connector Termination: Screw terminals Cable gland: PG9 for 6-8 mm dia. cable Ingress protection: IP67</p>	370678

MATING CABLE CONNECTOR OPTIONS FOR (D84) CONNECTOR TYPES *(Photo and drawing dimensions are for reference only)*

Connector and dimensions	Description	Part number
	<p>Female cable connector, straight exit (Field installable) 8-Pin (D84) Mates with standard male (M12) integral connector Termination: Screw terminals Cable gland: PG9 for 6-8 mm dia. cable Ingress protection: IP67</p>	370694
	<p>Female cable connector, 90° exit (Field installable) 8-Pin (D84) Mates with standard male (M12) integral connector Termination: Screw terminals Cable gland: PG9 for 6-8 mm dia. cable Ingress protection: IP67</p>	370699

E-Series Model EH Sensor, Analog and Start/Stop Outputs (M12) Cord Sets and (M16) Adapter Cable Options

M12 CORD SETS AND (M16) ADAPTER CABLE OPTIONS (Photo and drawing dimensions are for reference only)

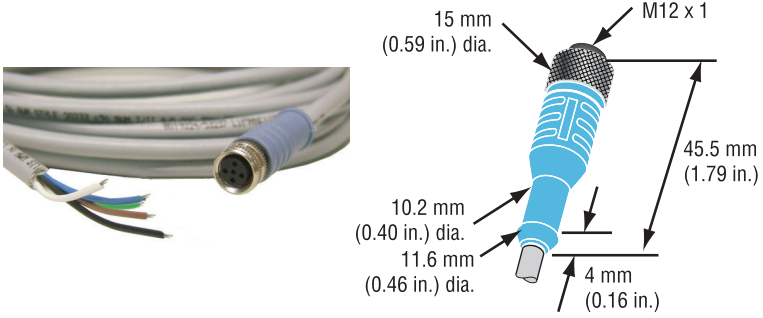
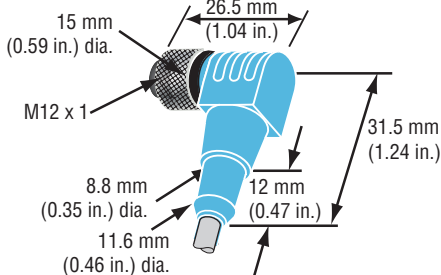
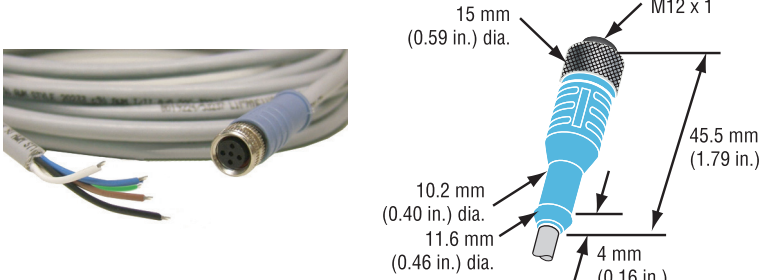
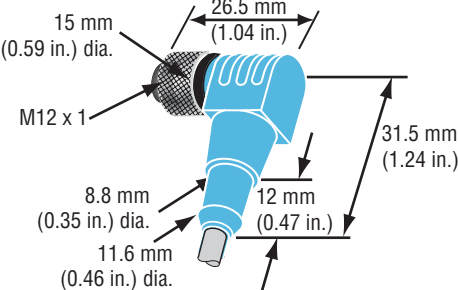
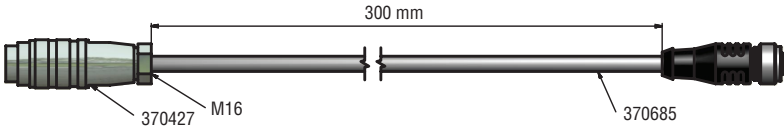
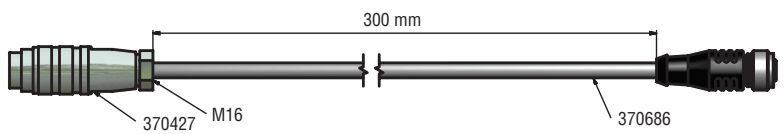
Cord set and dimensions	Description	Part number
	<p>M12 Cord set, female connector, Straight exit 5-Pin (M12) mates with standard male (D34) integral connector Ingress protection: IP67 Cable: 5 m, shielded, pigtail end</p>	<p>370685 (formerly 370673)</p>
<p>(Image not available)</p> 	<p>M12 Cord set, female connector 90° exit 5-Pin (M12) mates with standard male (D34) integral connector Ingress protection: IP67 Cable: 5 m, shielded, pigtail end</p>	<p>370675</p>
	<p>M12 Cord set, female connector, straight exit 8-Pin (M12) mates with standard male (D84) integral connector Ingress protection: IP67 Cable: 5 m, shielded, pigtail end</p>	<p>370686 (formerly 370674)</p>
<p>(Image not available)</p> 	<p>M12 Cord set, Female, Connector 90° Exit 8-Pin (M12) mates with standard male (D84) integral connector Ingress protection: IP67 Cable: 5 m, shielded, pigtail end</p>	<p>370676</p>
Adapter cable and dimensions	Description	Part number
	<p>Adapter cable 5-Pin female (M12) connector, straight exit to 6-pin male D60 (M16) connector, straight exit Ingress protection: IP67</p>	<p>254257</p>
	<p>Adapter cable 8-Pin female (M12) connector, straight exit to 6-pin male D60 (M16) connector, straight exit Ingress protection: IP67</p>	<p>254258</p>

E-Series Model EH Sensor, Analog and Start/Stop Outputs Ordering Information

Use the order matrix below to configure your Model EH sensor order number.

E	H																		
1	2	3	4	5	6	7	8	9	10	11	12	13	14	15					

- SENSOR MODEL** _____ = E H **1 - 2**
- EH** = E-Series model EH rod-style sensor (Magnet(s) must be ordered separately)
- ROD HOUSING AND FLANGE TYPE** _____ = **3**
- K** = Flange M18 x 1.5 / Rod 7 mm dia.
M = Flange M18 x 1.5 / Rod 10 mm dia.
W = Flange M18 x 1.5 / Rod 10 mm dia. (316L)
L = Flange 3/4 in. UNF / Rod 7 mm dia.
S = Flange 3/4 in. UNF / Rod 10 mm dia.
F = Flange 3/4 in. - UNF / Rod 10 mm dia. (316L)
- STROKE LENGTH** _____ = **4 - 8**
- **M** = Millimeters (Encode in 5, 10, 25 or 50 mm increments) as indicated in 'Stroke length notes' below.
- **U** = Inches (Encode in 0.2, 0.5, 1 or 2 in. increments) as indicated in 'Stroke length notes' below.

Stroke length Notes:

Stroke length ranges:
M = 50 mm to 2500 mm
U = 2 in. to 100 in.

The increment size between standard stroke lengths vary as shown below:

Stroke length (mm)	Ordering increment
≤ 500 mm	5 mm
> 500 mm and ≤ 750 mm	10 mm
> 750 mm and ≤ 1000 mm	25 mm
> 1000 mm and ≤ 2500 mm	50 mm
Stroke length (IN)	Ordering increment
≤ 20 in.	0.2 in.
> 20 in. and ≤ 30 in.	0.5 in.
> 30 in. and ≤ 40 in.	1 in.
> 40 in. and ≤ 100 in.	2 in.

- SENSOR CONNECTION TYPES** _____ = D **9 - 11**
- D34** = 5-Pin (M12), male (Analog output)
D84 = 8-Pin (M12), male (Start/Stop output)
- INPUT VOLTAGE** _____ = 1 **12**
- 1** = + 24 Vdc (+20%, -15%), standard
- OUTPUT** _____ = **13 - 15**
- VOLTAGE**
- V01** = 0 to 10 Vdc (1 output channel with 1 magnet)
V11 = 10 to 0 Vdc (1 output channel with 1 magnet)
V02 = 0 to 10 Vdc (2 output channels with 2 magnets) Refer to 'Dual magnet outputs' for more information.
V12 = 10 to 0 Vdc (2 output channels with 2 magnets) Refer to 'Dual magnet outputs' for more information.
V03 = 0 to 10 Vdc and 10 to 0 Vdc (2 output channels with 1 magnet)
- CURRENT**
- A01** = 4 to 20 mA (1 output channel with 1 magnet)
A11 = 20 to 4 mA (1 output channel with 1 magnet)
A02 = 4 to 20 mA (2 output channels with 2 magnets) Refer to 'Dual magnet outputs' for more information.
A12 = 20 to 4 mA (2 output channels with 2 magnets) Refer to 'Dual magnet outputs' for more information.
- START/STOP**
- R3** = Start/Stop with sensor parameters upload function
 Start/Stop output (Option **R3**) is fully compatible with the Start/Stop output (Option **R0**) used in the previous generation E-Series sensors.