

Dc to Pulse Width Modulator

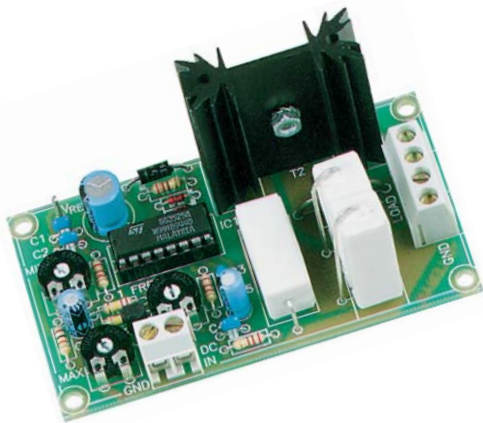

K8004

Allows very efficient control of DC motors, heaters or lights.

Features:

- ☑ PWM range: 0 to 100%.
- ☑ PWM frequency: 100 to 5000Hz adjustable.
- ☑ Minimum PWM offset: 0 to 20% adjustable.
- ☑ Adjustable sensitivity: 2.5 to 35VDC
- ☑ Short circuit protection.
- ☑ Overload protection: 6.5A

Specifications:

- Power Supply: 8 to 35VDC unregulated
- Supply current (No load): 35mA typ
- Efficiency: better than 90% at full load
- Dimensions (wxdxh): 85 x 48 x 45mm

1. Assembly (Skipping this can lead to troubles !)

Ok, so we have your attention. These hints will help you to make this project successful. Read them carefully.

1.1 Make sure you have the right tools:

- A good quality soldering iron (25-40W) with a small tip.
- Wipe it often on a wet sponge or cloth, to keep it clean; then apply solder to the tip, to give it a wet look. This is called 'thinning' and will protect the tip, and enables you to make good connections. When solder rolls off the tip, it needs cleaning.
- Thin rosin-core solder. Do not use any flux or grease.
- A diagonal cutter to trim excess wires. To avoid injury when cutting excess leads, hold the lead so they cannot fly towards the eyes.
- Needle nose pliers, for bending leads, or to hold components in place.
- Small blade and Phillips screwdrivers. A basic range is fine.

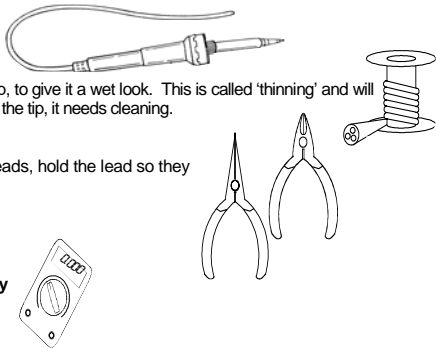

For some projects, a basic multi-meter is required, or might be handy

1.2 Assembly Hints :

- ⇒ Make sure the skill level matches your experience, to avoid disappointments.
- ⇒ Follow the instructions carefully. Read and understand the entire step before you perform each operation.
- ⇒ Perform the assembly in the correct order as stated in this manual
- ⇒ Position all parts on the PCB (Printed Circuit Board) as shown on the drawings.
- ⇒ Values on the circuit diagram are subject to changes.
- ⇒ Values in this assembly guide are correct*
- ⇒ Use the check-boxes to mark your progress.
- ⇒ Please read the included information on safety and customer service

* Typographical inaccuracies excluded. Always look for possible last minute manual updates, indicated as 'NOTE' on a separate leaflet.

1.3 Soldering Hints :

1- Mount the component against the PCB surface and carefully solder the leads

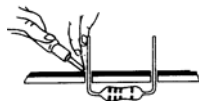

2- Make sure the solder joints are cone-shaped and shiny



3- Trim excess leads as close as possible to the solder joint

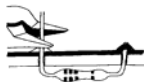

REMOVE THEM FROM THE TAPE ONE AT A TIME !

AXIAL COMPONENTS ARE TAPED IN THE CORRECT MOUNTING SEQUENCE !

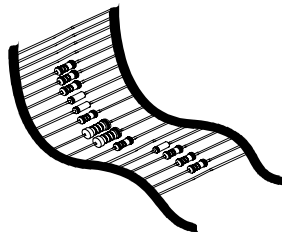

1. Diodes. Watch the polarity !

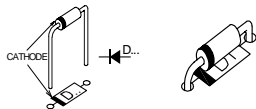

- D1 : 1N4148
- D2 : 1N4148
- D3 : 1N4007

3. IC socket. Watch the position of the notch!

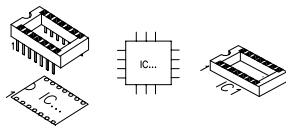

- IC1 : 16P

5. PCB pins

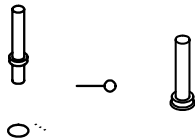

- Vref

2. Resistors

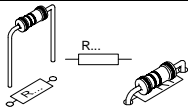

- R1 : 220 (2-2-1-B)
- R2 : 220 (2-2-1-B)
- R3 : 2K2 (2-2-2-B)
- R4 : 2K2 (2-2-2-B)
- R5 : 10K (1-0-3-B)
- R6 : 100K (1-0-4-B)
- R7 : 220K (2-2-4-B)

4. Trim potentiometer

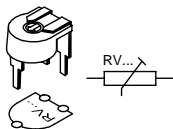

- RV1 : 10K
- RV2 : 10K
- RV3 : 250K

6. Ceramic Capacitors

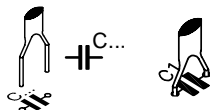

- C1 : 100nF (104)
- C2 : 100nF (104)
- C3 : 100nF (104)
- C4 : 100nF (104)

7. Transistor

- T1 : BC547

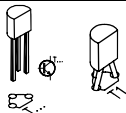
8. Electrolytic capacitor.
Watch the polarity !

- C5 : 10 μ F
 C6 : 10 μ F
 C7 : 100 μ F (40Vmin)

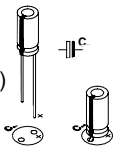

9. Diode, check the polarity

- D4 : 6A2 / 6A6

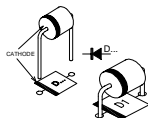

10. Screw connectors

- J1 : 2p

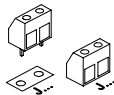

- J2 : 2p
 J3 : 2p

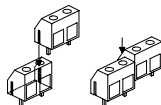

11. 5W Resistors

- R8 : 0,22 (R22)

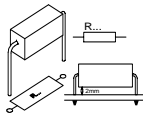

- R9 : 0,22 (R22)
 R10 : 0,22 (R22)

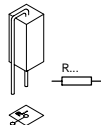

12. Transistor

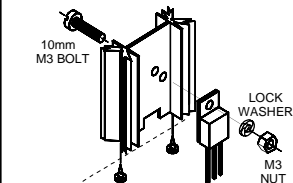

- T2 : BUK9535-55 or eq.

13. IC, Check the position of the notch !

- IC1 : SG3525

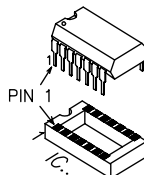

14. Test

- Connect the supplied 4k7 resistor between the + and - points of the load.
- Connect the Vref point to the DC input.
- Set preset RV3 to the middle of its adjustment range.
- Connect a DC voltage between 8 and 35V with the points +V and GND.
- Measure between the + and - points of LOAD with a voltmeter (set to read DC voltage).
- If everything goes well then the voltage on the output can be adjusted with RV2.

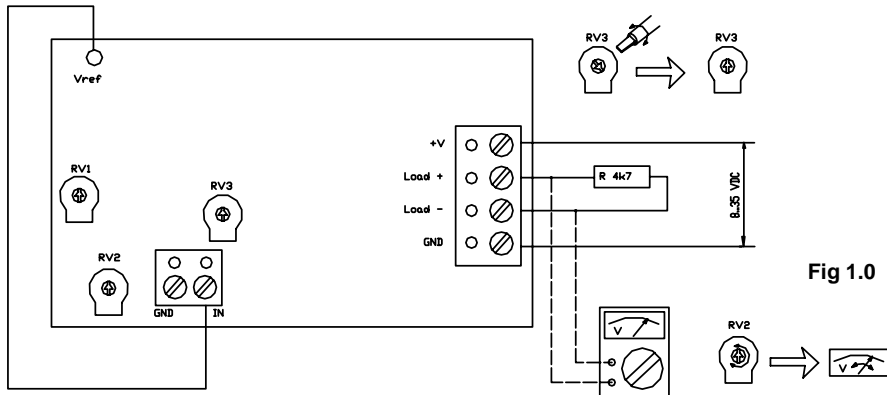
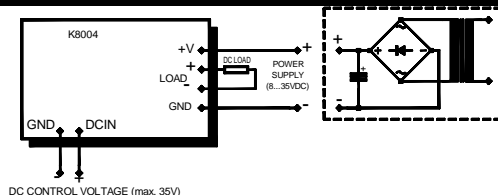

Fig 1.0

15. Different configurations

➤ Figure A :

Standard configuration, use a separate control voltage.



➤ Figure B :

Connection to one of the analogue outputs of the K8000 interface card. If DAC1 is used then the circuit can be controlled with the demo program, "dimmer".

The circuit can also be tested with the test program of the K8000.

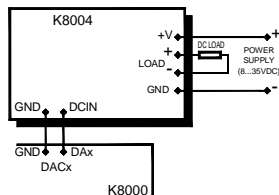

➤ Figure C :

Internal reference voltage used as control voltage.

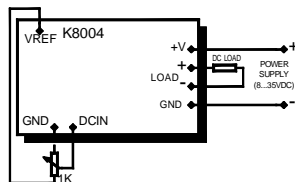

16. Setting up

- **RV1: setting the minimum output voltage.**
Set the control voltage to zero (perhaps by disconnecting it). An initial pre-voltage can then be adjusted using preset RV1. This is especially useful with motors (in order to overcome mechanical resistance) and with halogen lamps (in order to pre-heat the filament).
- **RV2: setting the maximum output voltage.**
Set the control voltage to the maximum voltage that you are going to use. The maximum output voltage can be adjusted with the preset, RV2 (useful for limiting motor speed or light intensity).
- **RV3: setting the output frequency.**
If an irritating noise can be heard in the load, then it can be resolved by adjusting the output frequency. The normal position of this preset is the middle of its range.

17. PCB

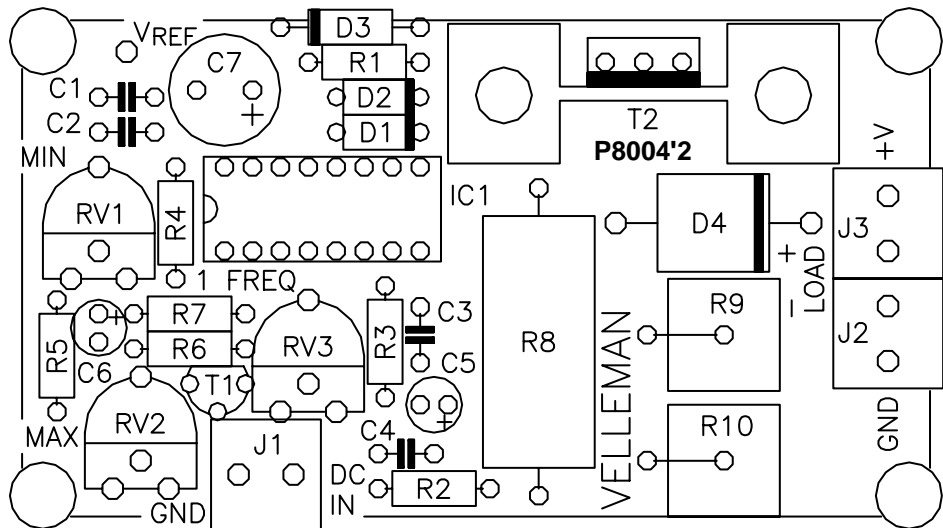

18. Schematic diagram.

