

Type 457, 458

Flanged Safety Relief Valves
– spring loaded

Metirc Units



Facts

LESER

Type 457, 458
Conventional design

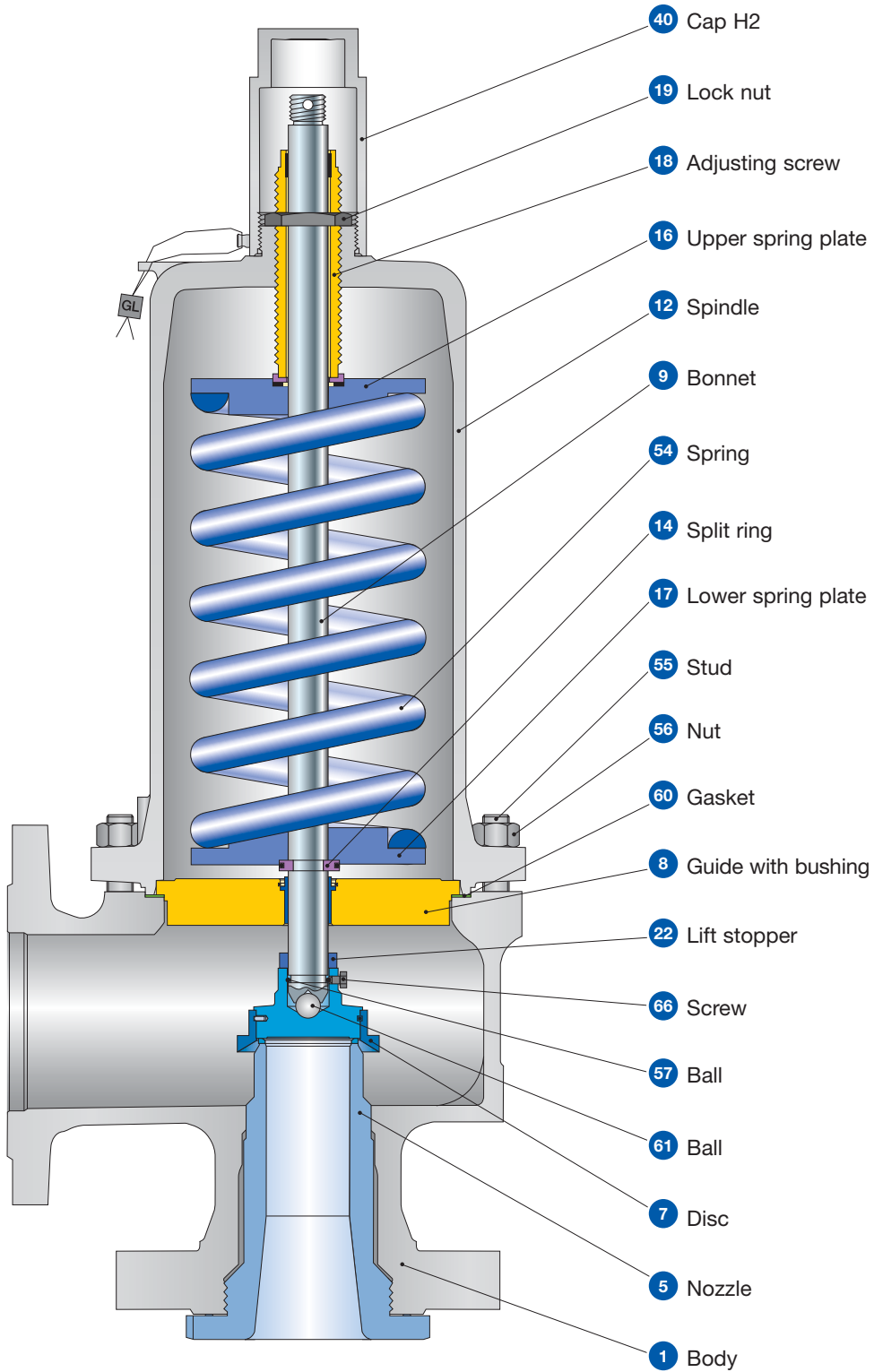

Type 457, 458

Type 457, 458

Conventional design

Materials

Item	Component	Type 4572 / 4582	Type 4577 / 4587	Type 4584
1	Body	1.0619	1.7357	1.4581
		SA 216 WCB	SA 217 WC6	SA 351 CF10M
5	Nozzle	1.4404 stellited	1.4404 stellited	1.4404 stellited
		316L stellited	316L stellited	316L stellited
7	Disc	1.4122	1.4122	1.4404
		Hardened stainless steel	Hardened stainless steel	316L
8	Guide with bushing	1.0501, 0.7040 Chrome or carbon steel	1.0501, 0.7040 Chrome or carbon steel	1.4404 316L
		1.4104 tenifer Chrome steel	1.4104 tenifer Chrome steel	–
9	Bonnet	0.7043 (Open bonnet 0.7040), 1.0619	0.7043 (Open bonnet 0.7040), 1.0619	1.4408, 1.4404, 1.4571
		Ductile Gr. 60-40-18, SA 216 WCB	Ductile Gr. 60-40-18, SA 216 WCB	SA 351 CF8M, SA 479 316L, 316Ti
12	Spindle	1.4404	1.4404	1.4404
		316L	316L	316L
14	Split ring	1.4104	1.4104	1.4404
		Chrome steel	Chrome steel	316L
16 / 17	Spring plate	1.0718	1.0718	1.4404
		Steel	Steel	316L
18	Adjusting screw with bushing	1.4104 PTFE	1.4104 PTFE	1.4404 PTFE
		Chrome steel PTFE	Chrome steel PTFE	316L PTFE
19	Lock nut	1.0718	1.0718	1.4404
		Steel	Steel	316L
22	Lift stopper	1.4404	1.4404	1.4404
		316L	316L	316L
40	Cap H2	1.0460	1.4404	1.4404
		SA 105	316L	316L
54	Spring standard	1.1200, 1.8159, 1.7102	1.1200, 1.8159, 1.7102	1.4310
		Carbon steel	Carbon steel	Stainless steel
	Spring optional	1.4310	1.4310	–
		Stainless steel	Stainless steel	–
55	Stud	1.4401	1.4401	1.4401
		B8M	B8M	B8M
56	Nut	1.4401	1.4401	1.4401
		8M	8M	8M
57	Ball	1.4401	1.4401	1.4401
		316	316	316
60	Gasket	Graphite / 1.4401	Graphite / 1.4401	Graphite / 1.4401
		Graphite / 316L	Graphite / 316L	Graphite / 316L
61	Ball	1.3541	1.3541	1.4401
		Hardened stainless steel	Hardened stainless steel	316
66	Screw	1.4401	1.4401	1.4401
		B8M	B8M	B8M

Please notice:

- Modifications reserved by LESER.
- LESER can upgrade materials without notice.
- Every part can be replaced by other material acc. to customer specification.

Type 457, 458
Balanced bellows design

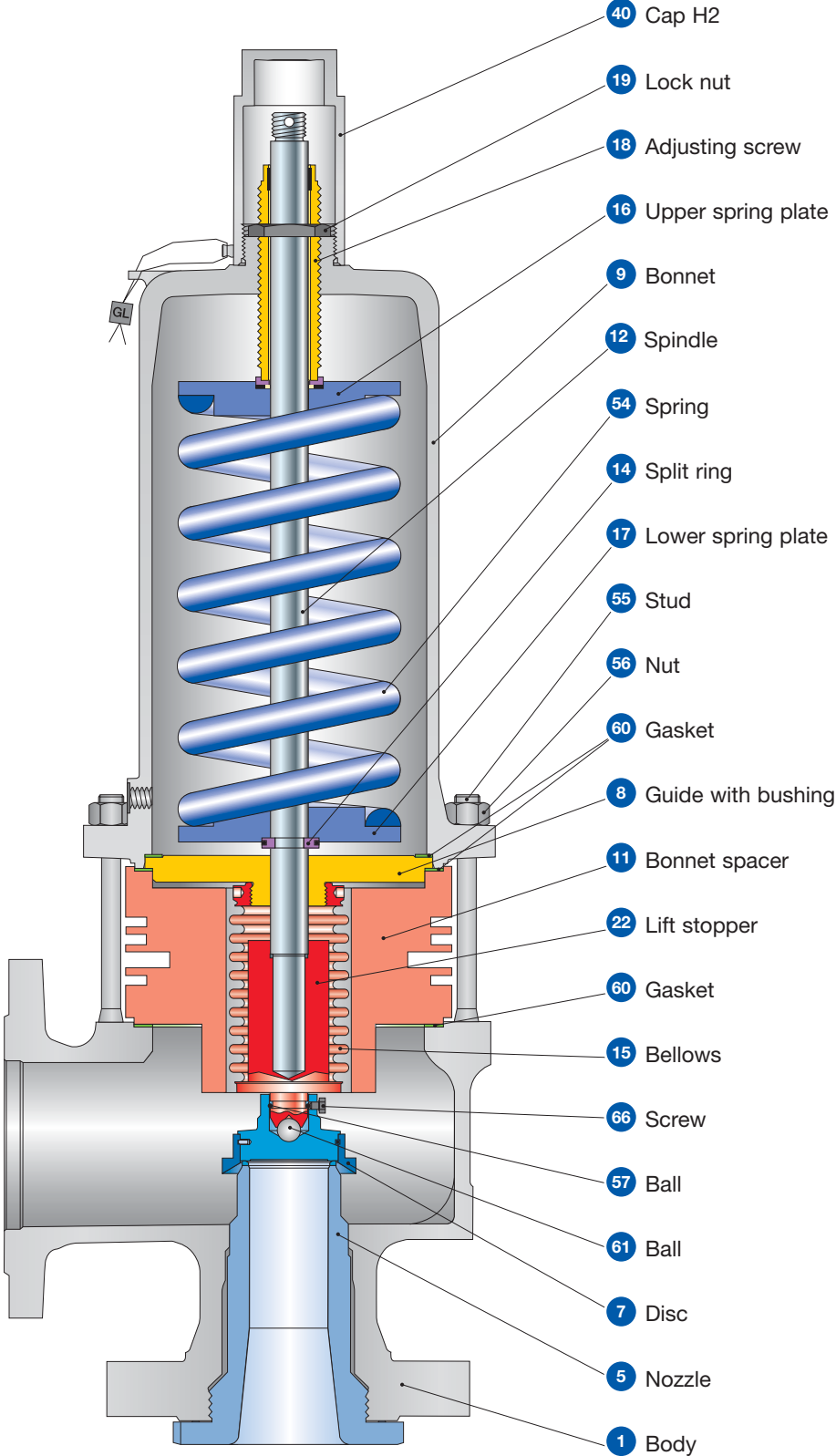

Type 457, 458

Balanced bellows design

Materials

Item	Component	Type 4572 / 4582	Type 4577 / 4587	Type 4584
1	Body	1.0619	1.7357	1.4581
		SA 216 WCB	SA 217 WC6	SA 351 CF10M
5	Nozzle	1.4404 stellited	1.4404 stellited	1.4404 stellited
		316L stellited	316L stellited	316L stellited
7	Disc	1.4122	1.4122	1.4404
		Hardened stainless steel	Hardened stainless steel	316L
8	Guide with bushing	1.0501, 0.7040	1.0501, 0.7040	1.4404
		Chrome or carbon steel	Chrome or carbon steel	316L
		1.4104 tenifer Chrome steel	1.4104 tenifer Chrome steel	-
9	Bonnet	0.7043 or 1.0619	0.7043 or 1.0619	1.4408, 1.4404, 1.4571
		Ductile Gr. 60-40-18 or SA 216 WCB	Ductile Gr. 60-40-18 or SA 216 WCB	SA 351 CF8M, SA 479 316L, 316Ti
11	Bonnet spacer	1.0460	1.0460	1.4404
		Carbon steel	Carbon steel	316L
12	Spindle	1.4404	1.4404	1.4404
		316L	316L	316L
14	Split ring	1.4104	1.4104	1.4404
		Chrome steel	Chrome steel	316L
15	Bellows	1.4571	1.4571	1.4571
		316Ti	316Ti	316Ti
16 / 17	Spring plate	1.0718	1.0718	1.4404
		Steel	Steel	316L
18	Adjusting screw with bushing	1.4104 PTFE	1.4104 PTFE	1.4404 PTFE
		Chrome steel PTFE	Chrome steel PTFE	316L PTFE
19	Lock nut	1.0718	1.0718	1.4404
		Steel	Steel	316L
22	Lift stopper	1.4404	1.4404	1.4404
		316L	316L	316L
40	Cap H2	1.0460	1.4404	1.4404
		SA 105	316L	316L
54	Spring standard	1.1200, 1.8159, 1.7102	1.1200, 1.8159, 1.7102	1.4310
		Carbon steel	Carbon steel	Stainless steel
	Spring optional	1.4310	1.4310	-
55	Stud	1.7709	1.7709	1.4401
		B16	B16	B8M
56	Nut	1.7258	1.7258	1.4401
		7M	7M	8M
57	Ball	1.4401	1.4401	1.4401
		316	316	316
60	Gasket	Graphite / 1.4401	Graphite / 1.4401	Graphite / 1.4401
		Graphite / 316L	Graphite / 316L	Graphite / 316L
61	Ball	1.3541	1.3541	1.4401
		Hardened stainless steel	Hardened stainless steel	316
66	Screw	1.4401	1.4401	1.4401
		B8M	B8M	B8M

Bitte beachten:

- LESER behält sich Änderungen vor.
- LESER kann, ohne vorherige Benachrichtigung, höherwertige Materials einsetzen.
- Jedes Bauteil kann entsprechend der Kundenspezifikation in einem anderen Werkstoff ausgeführt werden.

Type 457, 458

Article numbers

	DN _{I+O}	25 x 50	25 x 50	50 x 80	50 x 80	80 x 100	80 x 100
	Valve size	1" x 2"	1" x 2"	2" x 3"	2" x 3"	3" x 4"	3" x 4"
	Actual Orifice diameter d ₀ [mm]	15	20	30	40	50	60
	Actual Orifice area A ₀ [mm ²]	177	314	707	1257	1964	2827

Body material: 1.0619 (WCB)

Bonnet closed	H2	Art. No. 4582.	6102	6112	6122	6132	6142	6152
	H3	Art. No. 4582.	6103	6113	6123	6133	6143	6153
	H4	Art. No. 4582.	6104	6114	6124	6134	6144	6154
open	H3	Art. No. 4572.	6105	6115	6125	6135	6145	6155

Body material: 1.7357 (WC6)

Bonnet closed	H2	Art. No. 4587.	6302	6312	6322	6332	6342	6352
	H3	Art. No. 4587.	6303	6313	6323	6333	6343	6353
	H4	Art. No. 4587.	6304	6314	6324	6334	6344	6354
open	H3	Art. No. 4577.	6305	6315	6325	6335	6345	6355

Body material: 1.4581 (CF10M)

Bonnet closed	H2	Art. No. 4584.	6202	6212	6222	6232	6242	6252
	H4	Art. No. 4584.	6204	6214	6224	6234	6244	6254

	DN _{I+O}	100 x 150	100 x 150	100 x 150	100 x 150	150 x 250
	Valve size	4" x 6"	4" x 6"	4" x 6"	4" x 6"	6" x 10"
	Actual Orifice diameter d ₀ [mm]	50	60	74	88	110
	Actual Orifice area A ₀ [mm ²]	1964	2827	4301	6082	9503

Body material: 1.0619 (WCB)

Bonnet closed	H2	Art. No. 4582.	6162	6172	6182	6192	4602
	H3	Art. No. 4582.	-	-	-	-	-
	H4	Art. No. 4582.	6124	6174	6184	6194	4604
open	H3	Art. No. 4572.	6125	6175	6185	6195	4605

Body material: 1.7357 (WC6)

Bonnet closed	H2	Art. No. 4587.	6362	6372	6382	6392	-
	H3	Art. No. 4587.	-	-	-	-	-
	H4	Art. No. 4587.	6364	6374	6384	6394	-
open	H3	Art. No. 4577.	6365	6375	6385	6395	-

Body material: 1.4581 (CF10M)

Bonnet closed	H2	Art. No. 4584.	6262	6272	6282	6292	1.4408 (CF8M)	4732
	H4	Art. No. 4584.	6264	6274	6284	6294	4734	

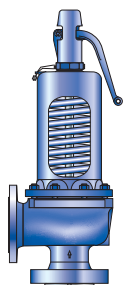

Type 457
Plain lever H3
Open bonnet
Conventional design

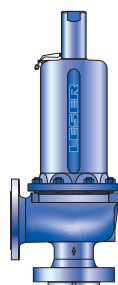

Type 458
Cap H2
Closed bonnet
Conventional design

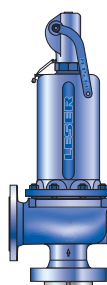

Type 458
Packed lever H4
Closed bonnet
Conventional design

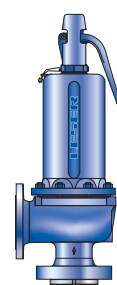

Type 458
Plain lever H3
Closed bonnet
Conventional design

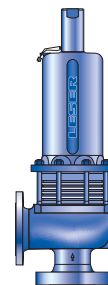

Type 458
Cap H2
Closed bonnet
Balanced bellows design

Type 457, 458

Dimensions and weights

Metric Units

	DN _{trO}	25 x 50	25 x 50	50 x 80	50 x 80	80 x 100	80 x 100	100 x 150	100 x 150	100 x 150	100 x 150	150 x 250
Valve size		1" x 2"	1" x 2"	2" x 3"	2" x 3"	3" x 4"	3" x 4"	4" x 6"	4" x 6"	4" x 6"	4" x 6"	6" x 10"
Actual Orifice diameter d _o [mm]		15	20	30	40	50	60	50	60	74	88	110
Actual Orifice area A _o [mm ²]		177	314	707	1257	1964	2827	1964	2827	4301	6082	9503
Weight [kg]		20	20	45	45	88	88	157	157	157	157	131
	with bellows	22	22	48	48	108	108	188	188	188	188	162
Center to face ¹⁾ [mm]	Inlet a	135	135	170	170	190	190	225	225	225	225	300
	Outlet b PN 40	120	120	145	145	180	180	235	235	235	235	225
	Outlet b PN 63	120	120	145	145	205	205	265	265	265	265	-
	Outlet b PN 160	130	130	-	-	-	-	-	-	-	-	-
Measure [mm]	PN 40 – 160	s	41	41	53	53	53	60	60	60	60	43
Used to find bolt length for inlet flange	PN 250	s	41	41	53	53	60	60	68	68	68	-
	PN 400	s	50	50	-	-	-	-	-	-	-	-
Height (H4) [mm]	Standard H max.	506	506	699	699	832	832	1079	1079	1079	1079	1098
	Bellows H max.	541	541	779	779	930	930	1170	1170	1170	1170	1156
Support brackets [mm]	A	140	140	184	184	278	278	364	364	364	364	320
	B	-	-	110	110	160	160	210	210	210	210	185
(drilled only on request, Option code H42)	C	Ø 14	Ø 14	Ø 14	Ø 14	Ø 18	Ø 18	Ø 18	Ø 18	Ø 18	Ø 18	Ø 18
	D	162	162	209	209	240	240	303	303	303	303	392
	E	18	18	18	18	27	27	32	32	32	32	28
Body material: 1.0619 (WCB)												
DIN Flange ²⁾	Inlet	PN 63 – 250					PN 63 – 160					PN 40
	Outlet	PN 40 – 63					PN 40					PN 16
Body material: 1.7357 (WC6)												
DIN Flange ²⁾	Inlet	PN 63 – 250					PN 63 – 160					-
	Outlet	PN 40 – 63					PN 40					-
Body material: 1.4581 (CF10M)												1.4408 (CF8M)
DIN Flange ²⁾	Inlet	PN 63 – 250					PN 63 – 160					PN 40
	Outlet	PN 40 – 63					PN 40					PN 16

¹⁾ Please note: For design with welding flanges attention should be paid to differing center to face dimensions.

²⁾ Standard flange rating. For other flange drillings please refer to page 97.

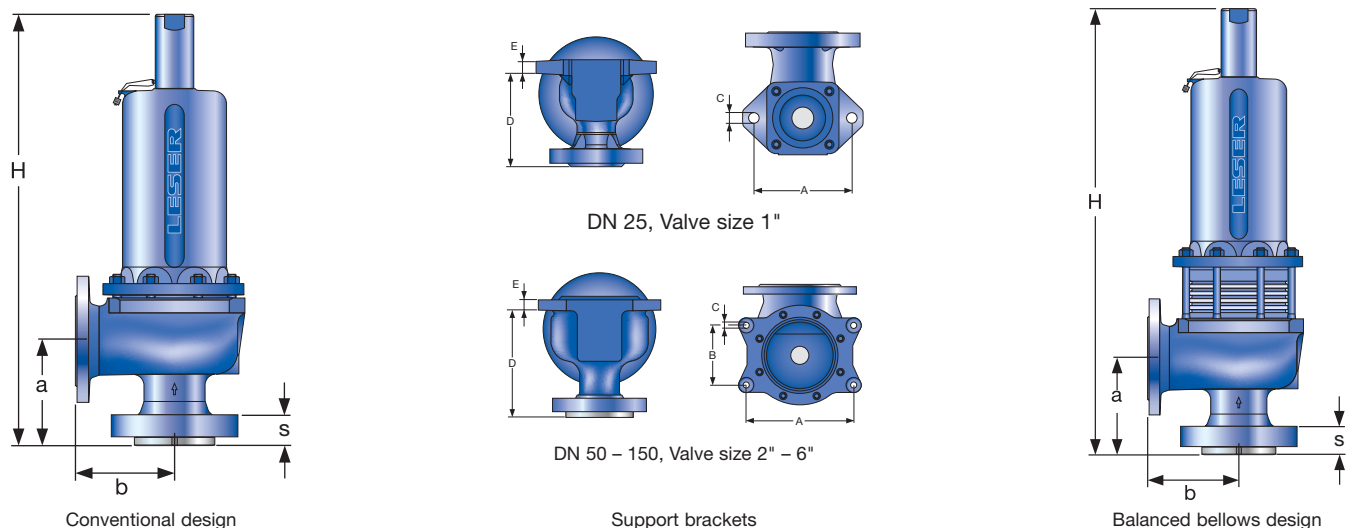

Type 457, 458

Pressure temperature ratings

Metric Units

DN _{ISO}	25 x 50	25 x 50	50 x 80	50 x 80	80 x 100	80 x 100	100 x 150	100 x 150	100 x 150	100 x 150	100 x 150	150 x 250	
Valve size	1" x 2"	1" x 2"	2" x 3"	2" x 3"	3" x 4"	3" x 4"	4" x 6"	4" x 6"	4" x 6"	4" x 6"	4" x 6"	6" x 10"	
Actual Orifice diameter d ₀ [mm]	15	20	30	40	50	60	50	60	74	88	110		
Actual Orifice area A ₀ [mm ²]	177	314	707	1257	1964	2827	1964	2827	4301	6082	9503		
Body material: 1.0619 (WCB)													
DIN Flange	Inlet	PN 63 – 250				PN 63 – 160						PN 40	
	Outlet	PN 40 – 63				PN 40						PN 40	
Minimum set pressure	p [bar _g] S/G/L	2.5	2.5	2.5	2.5	2.5	2.5	2.5	2.5	2.5	2.5	2.5	
Min. set pressure ¹⁾ standard bellows	p [bar _g] S/G/L	13.5	13.5	20	2.5	10	10	10	6	5	5	5	
Min. set pressure low press. bellows	p [bar _g] S/G/L					on request							
Maximaler set pressure	p [bar _g] S/G/L	300	180	125	98	130	77	43	46	53	34	18	
Max. set pressure with special spring	p [bar _g] S/G/L	300	180	210	114.5	160	77	160	160	77	53	40	
Temperature	min. [°C]							-85					
acc. to DIN EN	max. [°C]							+450					
Temperature	min. [°C]							-29					
acc. to ASME	max. [°C]							+427					
Body material: 1.7357 (WC6)													
DIN Flange	Inlet	PN 63 – 250				PN 63 – 160						–	
	Outlet	PN 40 – 63				PN 40						–	
Minimum set pressure	p [bar _g] S/G/L	2.5	2.5	2.5	2.5	2.5	2.5	2.5	2.5	2.5	2.5	–	
Min. set pressure ¹⁾ standard bellows	p [bar _g] S/G/L	13.5	13.5	20	2.5	10	10	10	6	5	5	–	
Min. set pressure low press. bellows	p [bar _g] S/G/L					on request						–	
Maximaler set pressure	p [bar _g] S/G/L	300	180	125	98	130	77	43	46	53	34	–	
Max. set pressure with special spring	p [bar _g] S/G/L	300	180	210	114.5	160	77	160	160	77	53	–	
Temperature	min. [°C]							-85					
acc. to DIN EN	max. [°C]							+550					
Temperature	min. [°C]							-29					
acc. to ASME	max. [°C]							+538					
Body material: 1.4581 (CF10M)												1.4408 (CF8M)	
DIN Flange	Inlet	PN 63 – 250				PN 63 – 160						PN 40	
	Outlet	PN 40 – 63				PN 40						PN 16	
Minimum set pressure	p [bar _g] S/G/L	2.5	2.5	2.5	2.5	2.5	2.5	2.5	2.5	2.5	2.5	2.5	
Min. set pressure ¹⁾ standard bellows	p [bar _g] S/G/L	13.5	13.5	20	2.5	10	10	10	6	5	5	5	
Min. set pressure low press. bellows	p [bar _g] S/G/L					on request						–	
Maximaler set pressure	p [bar _g] S/G/L	250	146	82	61	61	35	15.8	11	16.9	0	4.4	
Max. set pressure with special spring	p [bar _g] S/G/L	250	146	130	65	104	51.5	71	55	49	32	10	
Temperature	min. [°C]							-85					
acc. to DIN EN	max. [°C]							+550					
Temperature	min. [°C]							-29					
acc. to ASME	max. [°C]							+538					

¹⁾ Min. set pressure standard bellows = Max. set pressure low pressure bellows.

Type 457, 458

Available Options

Heating jacket

H29, H30: Couplings G $\frac{3}{8}$, G $\frac{3}{4}$
 H31, H32: Flanges DN 15, DN 25

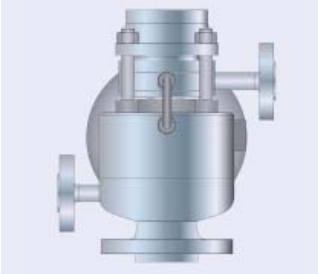

Drain hole

J18: G $\frac{1}{4}$
 J19: G $\frac{1}{2}$

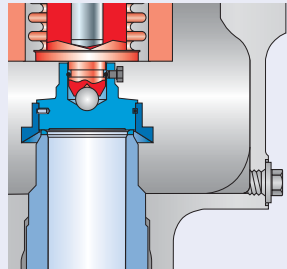

Open bonnet

See article number

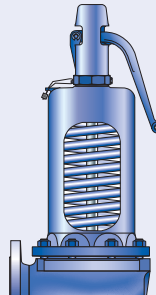

Butt-welded connection

S05

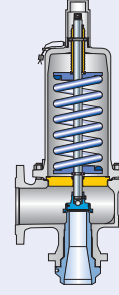

O-ring disc

J20: FFKM "C"
 J21: CR "K"
 J22: EPDM "D"
 J23: FKM "L"

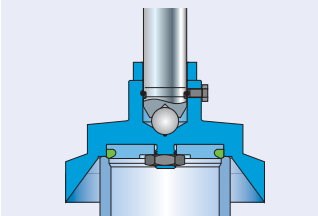

Stainless steel bellows

J68: Bonnet open
 J78: Bonnet closed

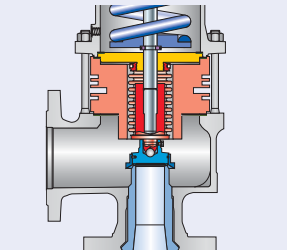

Conversion kit for stainless steel bellows

on request

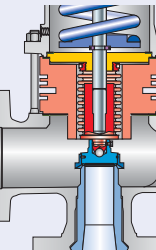

High temperature equipment

J88

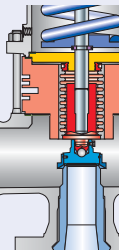

Screwed cap H2

H2

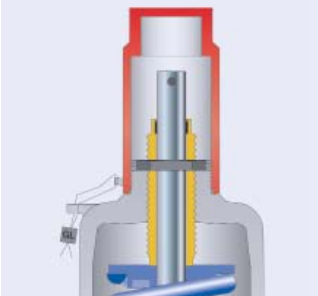

Plain lever H3

H3



Packed lever H4

H4

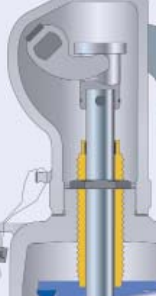

Test gag

J69: H4
 J70: H2

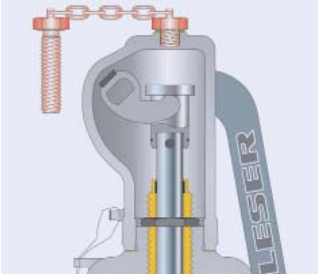

Lift indicator

J39: Adaptor H4
 J93: Lift indicator

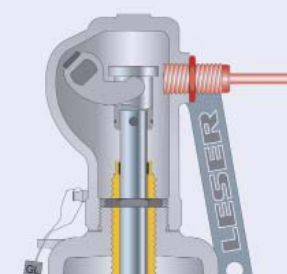

O-ring damper H2

J65

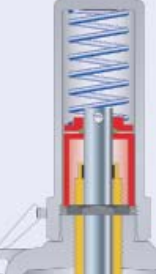

O-ring damper H4

J66

