

Xenus XTL™ User Guide



P/N 95-00875-000

Revision 3
June 2008

APPROVED

This page for notes.

TABLE OF CONTENTS

About This Manual 5

1: Introduction 9

 1.1: Amplifier 10

 1.2: CME 2 11

 1.3: CMO/CML 11

2: Operational Theory 13

 2.1: Amplifier Internal Power 14

 2.2: Synchronizing PWM Switching Frequency 16

 2.3: Commutation Modes 16

 2.4: Feedback 16

 2.5: Operating Modes 17

 2.6: CANopen Operation 28

 2.7: Limit Switches 30

 2.8: Brake Operation 31

 2.9: Status Indicators 32

 2.10: Protection 34

 2.11: Position and Velocity Errors 36

 2.12: Communication 39

 2.13: Inputs 40

 2.14: Outputs 41

 2.15: Regen Resistor Theory 42

3: Specifications 43

 3.1: Agency Approvals 44

 3.2: Power Input 44

 3.3: Power Output 44

 3.4: Control Loops 45

 3.5: Regen Circuit Output 45

 3.6: Digital Command Input 45

 3.7: Analog Command Input 46

 3.8: Digital Inputs 46

 3.9: Digital Outputs 46

 3.10: Brake Output 47

 3.11: Encoder Power Supply Output 47

 3.12: Primary Encoder Inputs 47

 3.13: Analog Encoder Inputs 47

 3.14: Hall Switch Inputs 48

 3.15: Resolver Interface 48

 3.16: Multi-Mode Port 48

 3.17: Serial Interface 49

 3.18: CAN Interface 49

 3.19: Status Indicators 49

 3.20: Fault Levels 49

 3.21: Power Dissipation 50

 3.22: Thermal Impedance 50

 3.23: Mechanical and Environmental 50

 3.24: Dimensions 51

4: Wiring 53

 4.1: General Wiring Instructions 54

 4.2: AC Mains (J1) 56

 4.3: Motor (J2) 57

 4.4: Regen Resistor (J3) (Optional) 59

 4.5: Logic Supply / Brake (J4) 60

 4.6: RS-232 Serial Communications (J5) 61

 4.7: CAN Bus (J6) 62

 4.8: Control (J7) 63

 4.9: Motor Feedback (J8) 67

5: Quick Setup with CME 2 73

 5.1: Warnings 74

 5.2: CME 2 Installation and Serial Port Setup 75

 5.3: Prerequisites 79

 5.4: Basic Setup 81

 5.5: Motor/Feedback Setup 84

 5.6: Amplifier Configuration 93

 5.7: Command Input 103

 5.8: Auto Phase 110

 5.9: Current Loop 116

 5.10: Velocity Loop 120

 5.11: Position Loop 122

 5.12: Completion Steps 126

6: Using CME 2 127

6.1: CME 2 Overview.....	128
6.2: Manage Amplifier and Motor Data	133
6.3: Downloading Firmware	136
6.4: Control Panel.....	138
6.5: Manual Phasing.....	142
6.6: Home Function.....	144
A: Regen Resistor Sizing and Configuration	145
A.1: Sizing a Regen Resistor.....	146
A.2: Configuring a Custom Regen Resistor	150
B: I²T Time Limit Algorithm	153
B.1: I ² T Algorithm	154
C: Thermal Considerations.....	159
C.1: Operating Temperature and Cooling Configurations	160
C.2: Heatsink Mounting Instructions	162
D: Xenus Filter.....	163
D.1: Overview.....	164
D.2: XTL-FA-01 Edge Filter Specifications	165
D.3: Thermal Considerations	165
D.4: XTL-FA-01 Edge Filter Dimensions.....	166
D.5: XTL-FA-01 Edge Filter Wiring	167
D.6: XTL-FA-01 Edge Filter Ordering.....	171
E: Connecting for Serial Control.....	173
E.1: Single-Axis and Multi-Drop	174
F: Ordering Guide and Accessories	175
F.1: Amplifier Model Numbers	176
F.2: Accessory Model Numbers.....	177
F.3: Order Example	178
F.5: Copley Standard Regen Resistor Specifications.....	179

ABOUT THIS MANUAL

Overview and Scope

This manual describes the operation and installation of the Xenus XTL amplifier manufactured by Copley Controls Corporation.

Related Documentation

For important setup and operation information, see the *CME 2 User Guide*.

Users of the CANopen features should also read these Copley Controls documents:

- *CANopen Programmer's Manual*
- *CML Reference Manual*
- *Copley Motion Objects Programmer's Guide*

Also of related interest:

- *Copley Indexer 2 Program User's Guide* (describes use of Indexer Program to create motion control sequences)
- *Copley Controls ASCII Interface Programmer's Guide* (describes how to send ASCII format commands over an amplifier's serial bus to set up and control one or more amplifiers)
- *Copley Amplifier Parameter Dictionary*
- *Copley Camming User Guide*
- *Copley DeviceNet Programmer's Guide*

Information on Copley Controls Software can be found at:

<http://www.copleycontrols.com/Motion/Products/Software/index.html>

Comments

Copley Controls Corporation welcomes your comments on this manual.

For contact information, see <http://www.copleycontrols.com>

Copyrights

No part of this document may be reproduced in any form or by any means, electronic or mechanical, including photocopying, without express written permission of Copley Controls Corporation.

Xenus and XTL are registered trademarks of Copley Controls Corporation.

CME 2 is a registered trademark of Copley Controls Corporation.

Windows NT, ME, 2000, XP, Vista, Visual Basic, Excel, and .NET are trademarks or registered trademarks of the Microsoft Corporation.

LabVIEW is a registered trademark of National Instruments.

Document Validity

We reserve the right to modify our products. The information in this document is subject to change without notice and does not represent a commitment by Copley Controls Corporation. Copley Controls Corporation assumes no responsibility for any errors that may appear in this document.

Product Warnings

Observe all relevant state, regional, and local safety regulations when installing and using this product. For safety and to assure compliance with documented system data, only Copley Controls Corporation should perform repairs to amplifiers.



DANGER: Hazardous voltages.

Exercise caution when installing and adjusting.

Failure to heed this warning can cause equipment damage, injury, or death.

DANGER



Risk of electric shock.

High-voltage circuits on J1, J2, and J3 are connected to mains power.

Failure to heed this warning can cause equipment damage, injury, or death.

DANGER



Risk of unexpected motion with non-latched faults.

After the cause of a non-latched fault is corrected, the amplifier re-enables the PWM output stage without operator intervention. In this case, motion may re-start unexpectedly. Configure faults as latched unless a specific situation calls for non-latched behavior. When using non-latched faults, be sure to safeguard against unexpected motion.

Failure to heed this warning can cause equipment damage, injury, or death.

DANGER



Using CME 2 or serial commands may affect or suspend CAN operations.

When operating the amplifier as a CAN node, the use of CME 2 or ASCII serial commands may affect CAN operations in progress. Using such commands to initiate motion may cause CAN operations to suspend.

CAN operations may restart unexpectedly when the commanded motion is stopped.

Failure to heed this warning can cause equipment damage, injury, or death.

DANGER



Latching an output does not eliminate the risk of unexpected motion with non-latched faults.

Associating a fault with a latched, custom-configured output does not latch the fault itself. After the cause of a non-latched fault is corrected, the amplifier re-enables without operator intervention. In this case, motion may re-start unexpectedly.

For more information, see [Clearing Non-Latched Faults \(p. 34\)](#).

Failure to heed this warning can cause equipment damage, injury, or death.

DANGER



Use equipment as described.

Operate amplifiers within the specifications provided in this manual.

Failure to heed this warning can cause equipment damage, injury, or death.

DANGER

Revision History

Revision	Date	DECO#	Comments
1	December 2007	16236	Initial release.
2	February 2008	16714	Updated Multi-Mode Port Interface Diagram (p. 66) .
3	June 2008	17111	Updated Web page references and made other minor changes.

This page for notes.

CHAPTER

1: INTRODUCTION

This chapter provides an overview of the Copley Controls Xenus XTL amplifier.

Contents include:

Title	Page
1.1: Amplifier	10
1.2: CME 2	11
1.3: CMO/CML	11

1.1: Amplifier

Xenus provides 100% digital control of brushless or brush motors in an off-line powered package. It can also control a Copley Controls ServoTube motor. Xenus can operate from single or three-phase mains with a continuous power output of up to 4 kW.

Xenus is offered in three versions to support three types of feedback devices. The standard version supports digital quadrature encoders. The –S version supports analog sin/cos encoders. The -R version supports brushless resolvers. The –S and -R versions can emulate a digital quadrature encoder output from the analog encoder or resolver respectively.

Xenus can operate in several basic ways:

- As a traditional motor amplifier accepting current, velocity or position commands from an external controller. In current and velocity modes it can accept ± 10 Vdc analog, digital 50% PWM or PWM/polarity inputs. In position mode, inputs can be incremental position commands from step-motor controllers in Pulse and Direction or Count Up/Count Down format, as well as A/B quadrature commands from a master-encoder. Pulse-to-position ratio is programmable for electronic gearing.
- As a node on a CANopen network. CANopen compliance allows the amplifier to take instruction from a master application over a CAN network to perform torque, velocity, and position profiling, interpolated motion, and homing operations. Multiple drives can be tightly synchronized for high performance coordinated motion.
- As a node on a DeviceNet network. Xenus can be operated over a DeviceNet network by PLCs and other controllers.
- As a stand-alone controller running Copley Virtual Machine (CVM) control programs such as the Indexer 2 Program. It can also be controlled directly over an RS232 serial link with simple ASCII format commands.

Mains input voltage to the amplifier can range from 100 to 240 Vac, single or three-phase, and 47 to 63 Hz. This allows Xenus the ability to work in the widest possible range of industrial settings. Several models are available, with peak current ratings of 18 to 40 amps:

Model					
Quad A/B Encoder	Resolver	Sin/Cos Encoder	Continuous Current	Peak Current	Vac
XTL-230-18	XTL-230-18-R	XTL-230-18-S	6 A	18 A	100 to 240
XTL-230-36	XTL-230-36-R	XTL-230-36-S	12 A	36 A	
XTL-230-40	XTL-230-40-R	XTL-230-40-S	20 A	40 A	

A separate +24 Vdc logic supply powers the internal logic and control circuits. These are isolated from the high-voltage power supply and inverter stage that connect to the mains. This simplifies system design by allowing the mains to be completely disconnected from the amplifier for safety reasons while allowing the logic side of the amplifier to stay powered. This allows the amplifier to retain position information and maintain communication through the digital I/O or over the serial or CAN ports when disconnected from the mains.

The Xenus XTL is RoHS compliant.

1.2: CME 2

Amplifier commissioning is fast and simple using Copley Controls CME 2 software. CME 2 communicates with Xenus via an RS-232 link, and all of the operations needed to configure the amplifier are accessible through CME 2.

The multi-drop feature allows CME 2 to use a single RS-232 serial connection to one amplifier as a gateway to other amplifiers linked together by CAN bus connections.

Auto phasing of brushless motor Hall sensors and phase wires eliminates “wire and try.” Connections are made once and CME 2 does the rest. Encoder or resolver wire swapping to establish the direction of positive motion is also eliminated.

Motor data can be saved as *.cm* files. Amplifier data is saved as *.ccx* files that contain all amplifier settings plus motor data. This makes it possible to quickly set up amplifiers by copying configurations from one amplifier to another.

1.3: CMO/CML

Copley Motion Libraries (CML) and Copley Motion Objects (CMO) make CANopen system commissioning fast and simple. All network housekeeping is taken care of automatically by a few simple commands linked into your application program. CML provides a suite of C++ libraries, allowing a C++ application program to communicate with and control an amplifier over the CANopen network. CMO provides a similar suite of COM objects that can be used by Visual Basic, .NET, LabVIEW, or any other program supporting the Microsoft COM object interface.

CHAPTER

2: OPERATIONAL THEORY

This chapter describes the basics of Xenus operation. Contents include:

Title	Page
2.1: Amplifier Internal Power.....	14
2.2: Synchronizing PWM Switching Frequency.....	16
2.3: Commutation Modes	16
2.4: Feedback.....	16
2.5: Operating Modes	17
2.6: CANopen Operation	28
2.7: Limit Switches	30
2.8: Brake Operation	31
2.9: Status Indicators.....	32
2.10: Protection	34
2.11: Position and Velocity Errors.....	36
2.12: Communication	39
2.13: Inputs	40
2.14: Outputs.....	41
2.15: Regen Resistor Theory.....	42

2.1: Amplifier Internal Power

Power distribution within Xenus is divided into three sections: +24 Vdc, logic/signal, and high voltage. Each is isolated from the other.

2.1.1: Logic/Signal Power

An internal DC/DC converter operates from the +24 Vdc Logic Supply input and creates the required logic/signal operating voltages, the isolated voltages required for the high-voltage control circuits, and a +5 Vdc supply for powering the motor encoder and Hall circuits. All the digital and analog inputs, digital outputs (with the exception of OUT4), Hall and encoder inputs are referenced to the same signal common. OUT4 is controlled through an opto-isolator, and is referenced to the +24 Vdc return. The CAN interface is also optically isolated.

Deriving internal operating voltages from a separate source enables the amplifier to stay on-line when the mains have been disconnected for emergency-stop or operator-intervention conditions. This allows CAN bus and serial communications to remain active so that the amplifier can be monitored by the control system while the mains power is removed.

2.1.2: High Voltage

Mains power drives the high-voltage section. It is rectified and capacitor-filtered to produce the DC bus: the DC “link” power that drives the PWM inverter, where it is converted into the voltages that drive a three-phase brushless or DC brush motor. An internal solid-state switch, together with an external power resistor, provides dissipation during regeneration when the mechanical energy of the motor is converted back into electrical energy. This prevents charging the internal capacitors to an overvoltage condition.

2.1.3: Power and Grounding Diagram

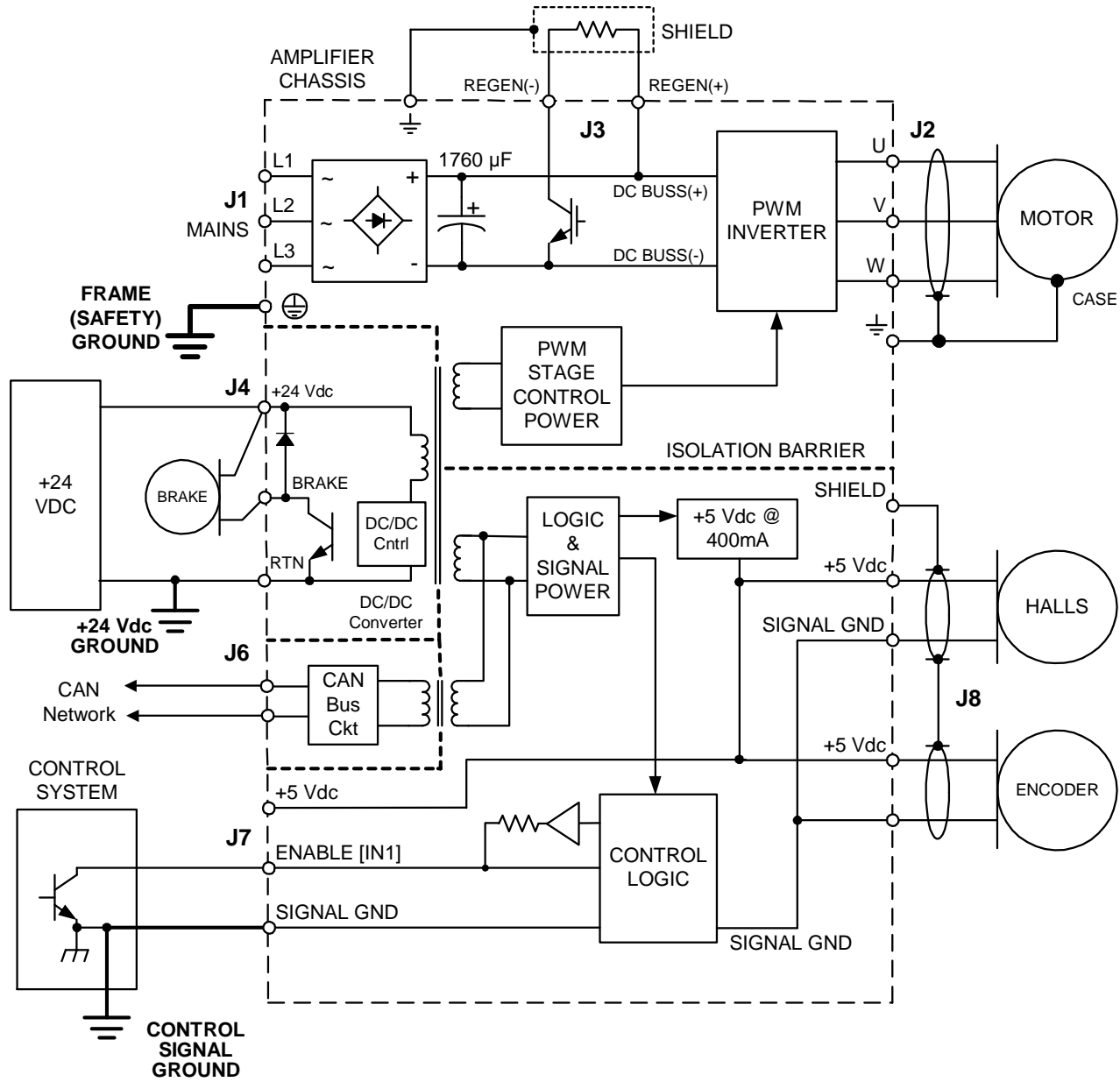

2.2: Synchronizing PWM Switching Frequency

In some situations, such as when sampling small analog signals, it is desirable to synchronize the PWM switching frequency among multiple amplifiers. In these cases, one amplifier serves as a master for one or more slave amplifiers. The PWM sync output of the master sends a signal that is received as a PWM sync input by each slave.

2.3: Commutation Modes

The amplifier supports three commutation modes to drive brush and brushless motors: AC brushless sinusoidal, AC brushless trapezoidal, and DC brush.

In most applications, sinusoidal commutation is preferred over trapezoidal, because it reduces torque ripple and offers the smoothest motion at any velocity or torque. In the sinusoidal commutation mode, an encoder or a resolver are required for all modes of operation.

In AC brushless trapezoidal commutation mode, the amplifier provides traditional six-step commutation.

When driving a DC brush motor, the amplifier operates as a traditional H-Bridge amplifier.

2.4: Feedback

2.4.1: Encoder and Resolver Support

The Xenus amplifier is offered in three versions to support encoder or resolver feedback. The standard version supports digital quadrature encoders. The -S version supports analog sin/cos encoders. These versions normally require the use of Hall switches for the commutation of brushless motors. The resolver version supports standard, single speed, transmit-type resolvers.

2.4.2: Multi-Mode Port

All versions support a multi-mode port. This interface can be configured to:

- Provide a buffered digital encoder output based on the digital encoder input.
- Provide an emulated digital encoder output based on the analog encoder or resolver input.
- Provide a second digital encoder input to be used in the dual encoder position mode. In this mode, an encoder attached to the load provides position loop feedback, and the motor encoder or resolver provides velocity loop feedback.

2.5: Operating Modes

2.5.1: Modes and Control Loops

Nesting of Control Loops and Modes

Copley Controls amplifiers use up to three nested control loops - current, velocity, and position - to control a motor in three associated operating modes.

Control Loops Illustration

In position mode, the amplifier uses all three loops. As shown below, the position loop drives the nested velocity loop, which drives the nested current loop.

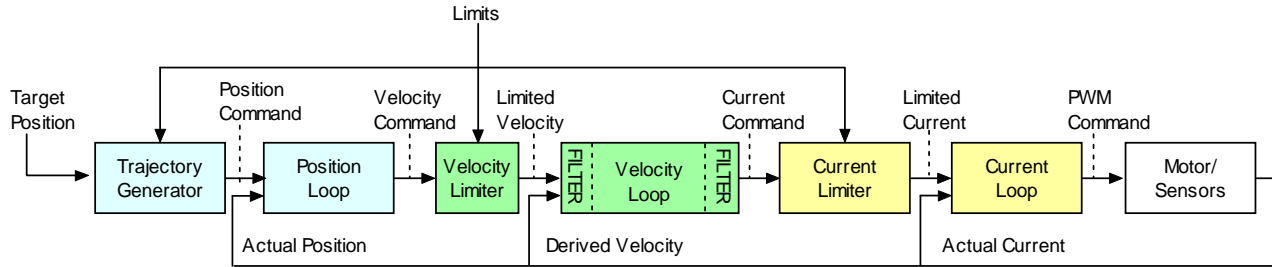

In velocity mode, the velocity loop drives the current loop. In current mode, the current loop is driven directly by external or internal current commands.

Basic Attributes of All Control Loops

These loops (and servo control loops in general) share several common attributes:

Loop Attribute	Description
Command input	Every loop is given a value to which it will attempt to control. For example, the velocity loop receives a velocity command that is the desired motor speed.
Limits	Limits are set on each loop to protect the motor and/or mechanical system.
Feedback	The nature of servo control loops is that they receive feedback from the device they are controlling. For example, the position loop uses the actual motor position as feedback.
Gains	These are constant values that are used in the mathematical equation of the servo loop. The values of these gains can be adjusted during amplifier setup to improve the loop performance. Adjusting these values is often referred to as <i>tuning</i> the loop.
Output	The loop generates a control signal. This signal can be used as the command signal to another control loop or the input to a power amplifier.

2.5.2: Current Mode and Current Loop

Current Loop Diagram

As shown below, the “front end” of the current loop is a limiting stage. The limiting stage accepts a current command, applies limits, and passes a limited current command to the summing junction. The summing junction takes the limited current command, subtracts the actual current (represented by the feedback signal), and produces an error signal. This error signal is then processed using the integral and proportional gains to produce a command. This command is then applied to the amplifier’s power stage.

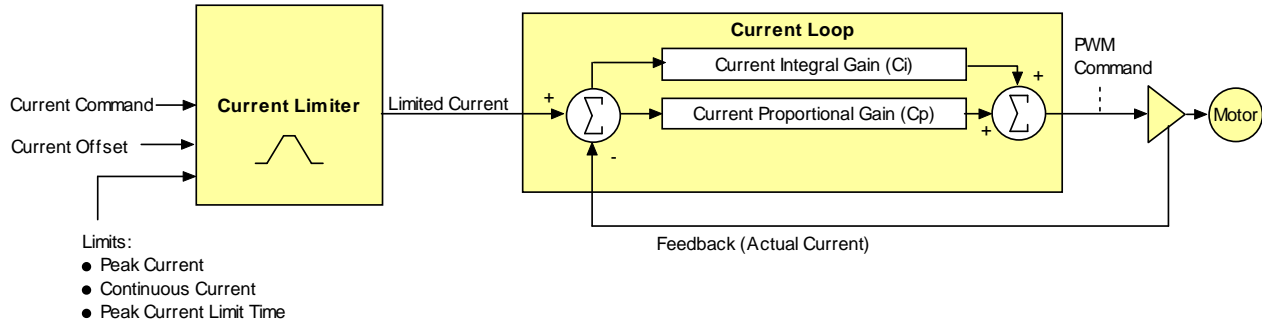

Current Loop Inputs

- The amplifier’s analog or PWM inputs.
- A network command, CANopen, DeviceNet, or RS-232 Serial.
- A Copley Virtual Motion (CVM) control program.
- The amplifier’s internal function generator.

In velocity or position modes, the current command is generated by the velocity loop.

Offset

The current loop offset is intended for use in applications where there is a constant force applied to, or required of, the servomotor and the system must control this force. Typical applications would be a vertical axis holding against gravity, or web tensioning. This offset value is summed with the current command before the limiting stage.

Limits

The current command is limited based on the following parameters:

Limiters	Description
Peak Current Limit	Maximum current that can be generated by the amplifier for a short duration of time. This value cannot exceed the peak current rating of the amplifier.
Continuous Current Limit	Maximum current that can be constantly generated by the amplifier.
I^2T Time Limit	Maximum amount of time that the peak current can be applied to the motor before it must be reduced to the continuous limit or generate a fault. For more details, see I²T Time Limit Algorithm (p. 153) . Note: Although the current limits set by the user may exceed the amplifier’s internal limits, the amplifier operates using both sets of limits in parallel, and therefore will not exceed its own internal limits regardless of the values programmed.
Ramp	Rate of change in current command.

Current Loop Gains

The current loop uses these gains:

Gain	Description
Cp - Current loop proportional	The current error (the difference between the actual and the limited commanded current) is multiplied by this value. The primary effect of this gain is to increase bandwidth (or decrease the step-response time) as the gain is increased.
Ci - Current loop integral	The integral of the current error is multiplied by this value. Integral gain reduces the current error to zero over time. It controls the DC accuracy of the loop, or the flatness of the top of a square wave signal. The error integral is the accumulated sum of the current error value over time.

Current Loop Output

The output of the current loop is a command that sets the duty cycle of the PWM output stage of the amplifier.

Auto Tune

CME 2 provides a current loop Auto Tune feature, which automatically determines optimal Cp and Ci values for the motor. For more information, see [Auto Tune the Current Loop \(p. 117\)](#).

2.5.3: Velocity Mode and Velocity Loop

Velocity Loop Diagram

As shown below, the velocity loop limiting stage accepts a velocity command, applies limits, and passes a limited velocity command to the input filter. The filter then passes a velocity command to the summing junction. The summing junction subtracts the actual velocity, represented by the feedback signal, and produces an error signal. (The velocity loop feedback signal is always from the motor feedback device even when an additional encoder is attached to the load.) The error signal is then processed using the integral and proportional gains to produce a current command. Programmable digital filters are provided on both the input and output command signals.

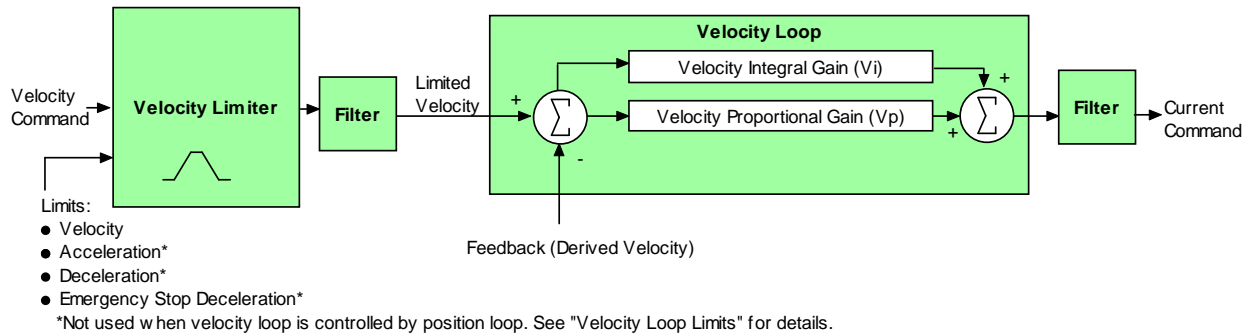

Inputs

In velocity mode, the velocity command comes from one of the following:

- The amplifier’s analog or PWM inputs.
- A network command, CANopen, DeviceNet, or RS-232 Serial.
- A Copley Virtual Motion (CVM) control program.
- The amplifier’s internal function generator.

In position mode, the velocity command is generated by the position loop.

Velocity Loop Limits

The velocity command is limited based on the following set of parameters designed to protect the motor and/or the mechanical system.

Limitier	Description
Velocity Limit	Sets the maximum velocity command input to the velocity loop.
Acceleration Limit	Limits the maximum acceleration rate of the commanded velocity input to the velocity loop. This limit is used in velocity mode only.
Deceleration Limit	Limits the maximum deceleration rate of the commanded velocity input to the velocity loop. This limit is used in velocity mode only.
Fast Stop Ramp	Specifies the deceleration rate used by the velocity loop when the amplifier is hardware disabled. (Fast stop ramp is not used when amplifier is software disabled.) If the brake delay option is programmed, the fast stop ramp is used to decelerate the motor before applying the brake. Note that Fast Stop Ramp is used only in velocity mode. In position mode, the trajectory generator handles controlled stopping of the motor. There is one exception: if a non-latched following error occurs in position mode, then the amplifier drops into velocity mode and the Fast Stop Ramp is used. For more information, see Following Error Fault Details (p. 37) .

Diagram: Effects of Limits on Velocity Command

The following diagram illustrates the effects of the velocity loop limits.

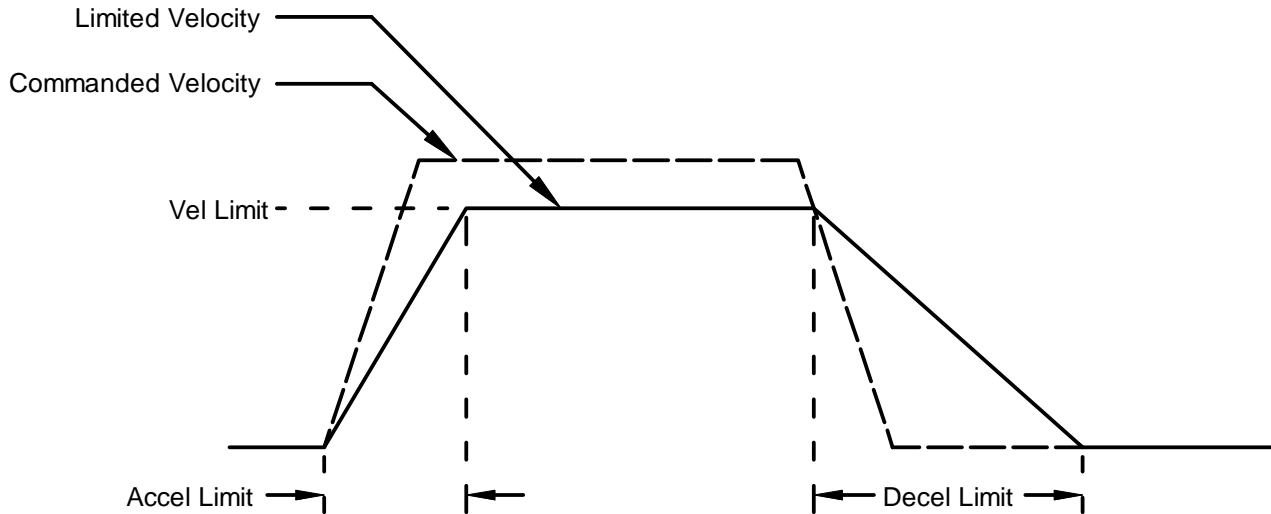

Velocity Loop Gains

The velocity loop uses these gains:

Gain	Description
Vp - Velocity loop proportional	The velocity error (the difference between the actual and the limited commanded velocity) is multiplied by this gain. The primary effect of this gain is to increase bandwidth (or decrease the step-response time) as the gain is increased.
Vi - Velocity loop integral	The integral of the velocity error is multiplied by this value. Integral gain reduces the velocity error to zero over time. It controls the DC accuracy of the loop, or the flatness of the top of a square wave signal. The error integral is the accumulated sum of the velocity error value over time.

Velocity Loop Gains Scalar

The *Enable Gains Scalar* feature increases or decreases the resolution of the units used to express Vp and Vi, providing more precise tuning.

Velocity Loop Command and Output Filters

The velocity loop contains two programmable digital filters. The input filter should be used to reduce the effects of a noisy velocity command signal. The output filter can be used to reduce the excitation of any resonance in the motion system.

Two filter classes can be programmed: the Low-Pass and the Custom Bi-Quadratic. The Low-Pass filter class includes the Single-Pole and the Two-Pole Butterworth filter types. The Custom Bi-Quadratic filter allows advanced users to define their own filters incorporating two poles and two zeros.

For more information on the velocity loop filters, see the *CME 2 User Guide*.

Velocity Loop Outputs

The output of the velocity loop is a current command used as the input to the current loop.

2.5.4: Position Mode and Position Loop

Position Loop Diagram

The amplifier receives position commands from the digital or analog command inputs, over the CAN interface or serial bus, or from the CVM Control Program. When using digital or analog inputs, the amplifier's internal trajectory generator calculates a trapezoidal motion profile based on trajectory limit parameters. When using the CAN bus, serial bus, or CVM Control Program, a trapezoidal or S-curve profile can be programmed. The trajectory generator updates the calculated profile in real time as position commands are received.

The output of the generator is an instantaneous position command (limited position). In addition, values for the instantaneous profile velocity and acceleration are generated. These signals, along with the actual position feedback, are processed by the position loop to generate a velocity command.

To bypass the trajectory generator while in digital or analog position modes, set the maximum acceleration to zero. The only limits in effect will now be the velocity loop velocity limit and the current limits. (Note that leaving the maximum acceleration set to zero will prevent other position modes from operating correctly.)

The following diagram summarizes the position loop.

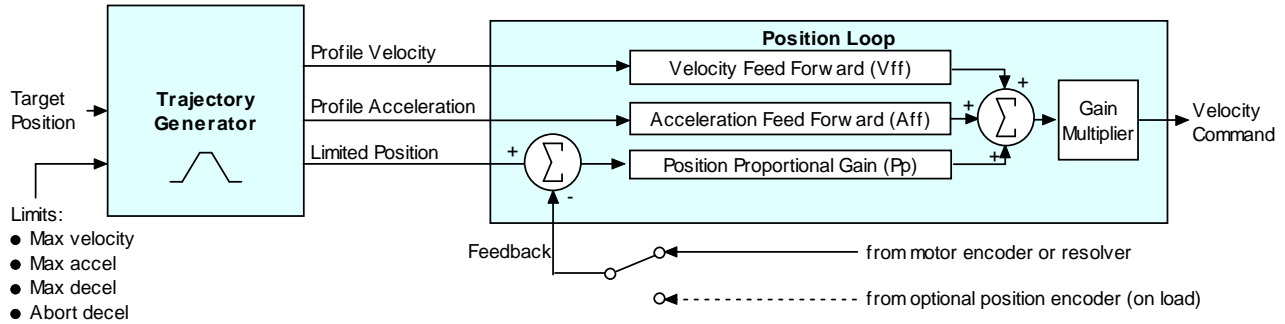

Trajectory Limits

In position mode, the trajectory generator applies the following user-set limits to generate the motion profile.

Limiter	Description
Maximum Velocity	Limits the maximum speed of the profile.
Maximum Acceleration	Limits the maximum acceleration rate of the profile.
Maximum Deceleration	Limits the maximum deceleration rate of the profile.
Abort Deceleration	Specifies the deceleration rate used by the trajectory generator when motion is aborted.

Position Loop Inputs From the Trajectory Generator

The position loop receives the following inputs from the trajectory generator.

Input	Description
Profile Velocity	The instantaneous velocity value of the profile. Used to calculate the velocity feed forward value.
Profile Acceleration	The instantaneous acceleration/deceleration value of the profile. Used to calculate the acceleration feed forward value.
Limited Position	The instantaneous commanded position of the profile. Used with the actual position feedback to generate a position error.

Position Loop Gains

The following gains are used by the position loop to calculate the velocity command:

Gain	Description
Pp - Position loop proportional	The loop calculates the position error as the difference between the actual and limited position values. This error in turn is multiplied by the proportional gain value. The primary effect of this gain is to reduce the following error.
Vff - Velocity feed forward	The value of the profile velocity is multiplied by this value. The primary effect of this gain is to decrease following error during constant velocity.
Aff - Acceleration feed forward	The value of the profile acceleration is multiplied by this value. The primary effect of this gain is to decrease following error during acceleration and deceleration.
Gain Multiplier	The output of the position loop is multiplied by this value before being passed to the velocity loop.

Position Loop Feedback

Xenus supports two position feedback configurations

- Single sensor. Position loop feedback comes from the encoder or resolver on the motor.
- Dual sensor. Position loop feedback comes from the encoder attached to the load.

(Note that in either case, velocity loop feedback comes from the motor encoder or resolver.) For more information, see [Feedback \(p. 16\)](#).

Position Loop Output

The output of the position loop is a velocity command used as the input to the velocity loop.

2.5.5: Input Command Types

The amplifier can be controlled by a variety of external sources: analog voltage or digital inputs, CAN network (CANopen or DeviceNet), or over an RS-232 serial connection using ASCII commands. The amplifier can also function as a stand-alone motion controller running an internal CVM program or using its internal function generator.

2.5.6: Analog Command Input

Overview

The amplifier can be driven by an analog voltage signal through the analog command input. The amplifier converts the signal to a current, velocity, or position command as appropriate for current, velocity, or position mode operation, respectively.

The analog input signal is conditioned by the scaling, dead band, and offset settings.

Scaling

The magnitude of the command generated by an input signal is proportional to the input signal voltage. Scaling controls the input-to-command ratio, allowing the use of an optimal command range for any given input voltage signal range.

For example, in current mode, with default scaling, +10 Vdc of input generates a command equal to the amplifier's peak current output; +5 Vdc equals half of that.

Scaling could also be useful if, for example, the signal source generates a signal range between 0 and +10 Vdc, but the command range only requires +7.5 Vdc of input. In this case, scaling allows the amplifier to equate +7.5 Vdc with the amplifier's peak current (in current mode) or maximum velocity (in velocity mode), increasing the resolution of control.

Dead Band

To protect against unintended response to low-level line noise or interference, the amplifier can be programmed with a "dead band" to condition the response to the input signal voltage. The

amplifier treats anything within the dead band ranges as zero, and subtracts the dead band value from all other values. For instance, with a dead band of 100 mV, the amplifier ignores signals between -100 mV and $+100$ mV, and treats 101 mV as 1 mV, 200 mV as 100 mV, and so on.

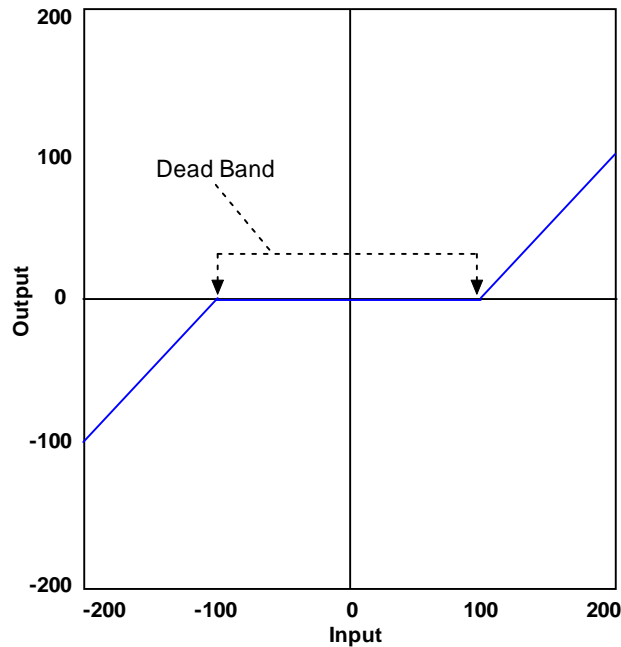

Offset

To remove the effects of voltage offsets between the controller and the amplifier in open loop systems, CME 2 provides an *Offset* parameter and a *Measure* function. The *Measure* function takes 10 readings of the analog input voltage over a period of approximately 200 ms, averages the readings, and then displays the results. The *Offset* parameter allows the user to enter a corrective offset to be applied to the input voltage.

The offset can also set up the amplifier for bi-directional operation from a uni-polar input voltage. An example of this would be a 0 to +10 Vdc velocity command that had to control 1000 rpm CCW to 1000 rpm CW. Scale would be set to 2000 rpm for a +10 Vdc input and Offset set to -5V. After this, a 0 Vdc input command would be interpreted as -5 Vdc, which would produce 1000 rpm CCW rotation. A +10 Vdc command would be interpreted as +5 Vdc and produce 1000 rpm CW rotation.

Monitoring the Analog Command Voltage

The analog input voltage can be monitored in the CME 2 control panel and oscilloscope. The voltage displayed in both cases is after both offset and deadband have been applied.

Analog Command in Position Mode

The Xenus Analog Position command operates as a relative motion command. When the amplifier is enabled the voltage on the analog input is read. Then any change in the command voltage will move the axis a relative distance, equal to the change in voltage, from its position when enabled.

To use the analog position command as an absolute position command, the amplifier should be homed every time it is enabled. The Homing sequence may be initiated by CAN, ASCII serial, or CVM Indexer program commands.

2.5.7: PWM Input

Two Formats

The amplifier can accept a pulse width modulated signal (PWM) signal to provide a current command in current mode and a velocity command in velocity mode. The PWM input can be programmed for two formats: 50% duty cycle (one-wire) and 100% duty cycle (two-wire).

50% Duty Cycle Format (One-Wire)

The input takes a PWM waveform of fixed frequency and variable duty cycle. As shown below, a 50% duty cycle produces zero output from the amplifier. Increasing the duty cycle toward 100% commands a positive output, and decreasing the duty cycle toward zero commands a negative output.

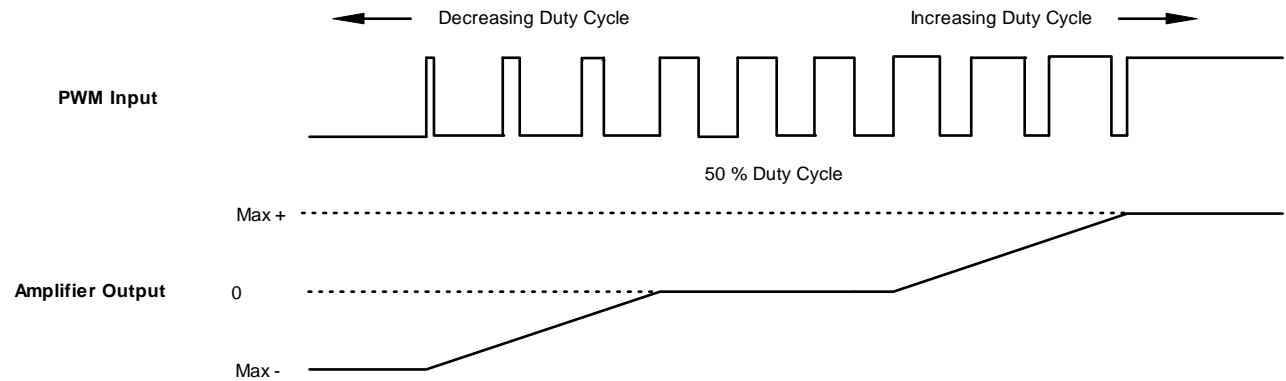

The command can be inverted so that increased duty cycle commands negative output and vice versa.

100% Duty Cycle Format (Two-Wire)

One input takes a PWM waveform of fixed frequency and variable duty cycle, and the other input takes a DC level that controls the polarity of the output. A 0% duty cycle creates a zero command, and a 100% duty cycle creates a maximum command level. The command can be inverted so that increasing the duty cycle decreases the output and vice versa.

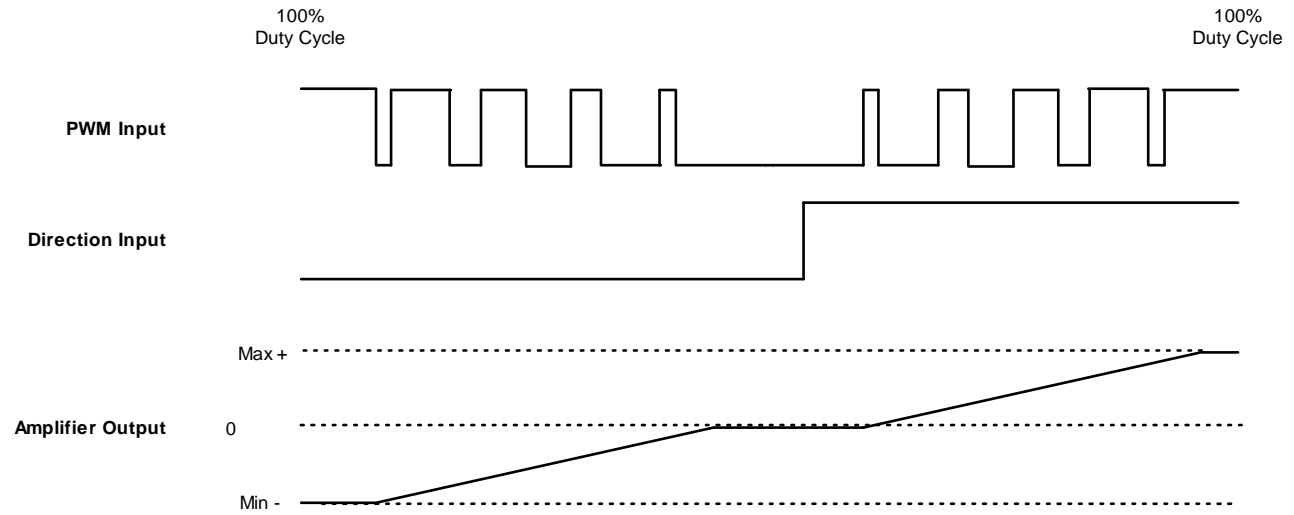

Failsafe Protection from 0 or 100% Duty Cycle Commands

In both formats, the amplifier can be programmed to interpret 0 or 100% duty cycle as a zero command. This provides a measure of safety in case of a controller failure or a cable break.

2.5.8: Digital Input

Three Formats

In position mode, the amplifier can accept position commands via two digital inputs, using one of these signal formats: pulse and direction, count up/count down, and quadrature.

In all three formats, the amplifier can be configured to invert the command.

Pulse Smoothing

In position mode, the amplifier's trajectory generator ensures smooth motion even when the command source cannot control acceleration and deceleration rates.

When using digital or analog command inputs, the trajectory generator can be disabled by setting the Max Accel limit to zero. (Note that when using the CAN bus, serial bus, or CVM Control Program, setting Max Accel to zero prevents motion.)

Pulse and Direction Format

In pulse and direction format, one input takes a series of pulses as motion step commands, and another input takes a high or low signal as a direction command, as shown below.

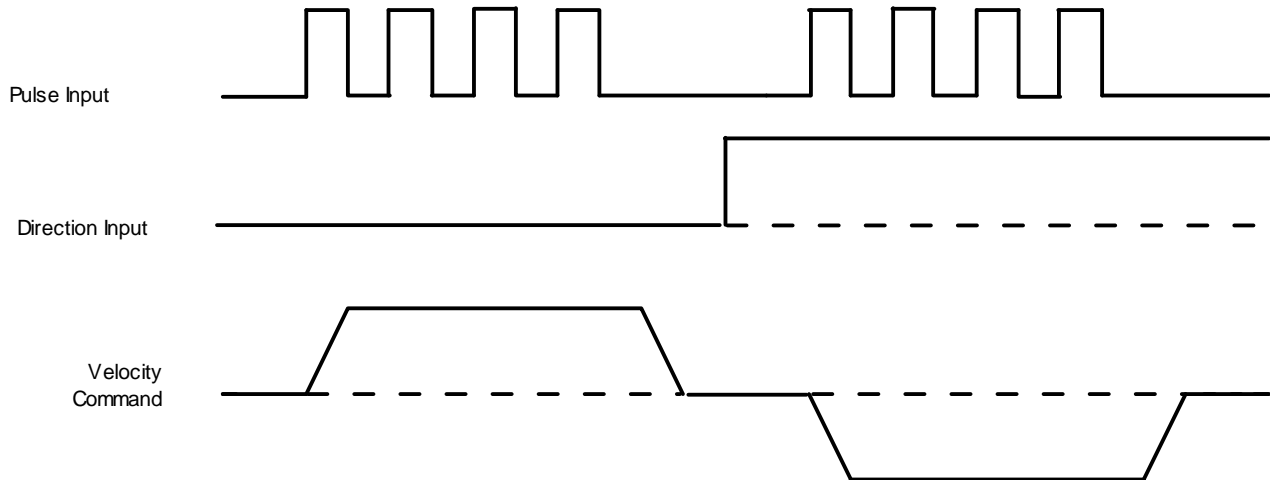

The amplifier can be set to increment position on the rising or falling edge of the signal. Stepping resolution can be programmed for electronic gearing.

Count Up/Count Down Format

In the count up/count down format, one input takes each pulse as a positive step command, and another takes each pulse as a negative step command, as shown below.

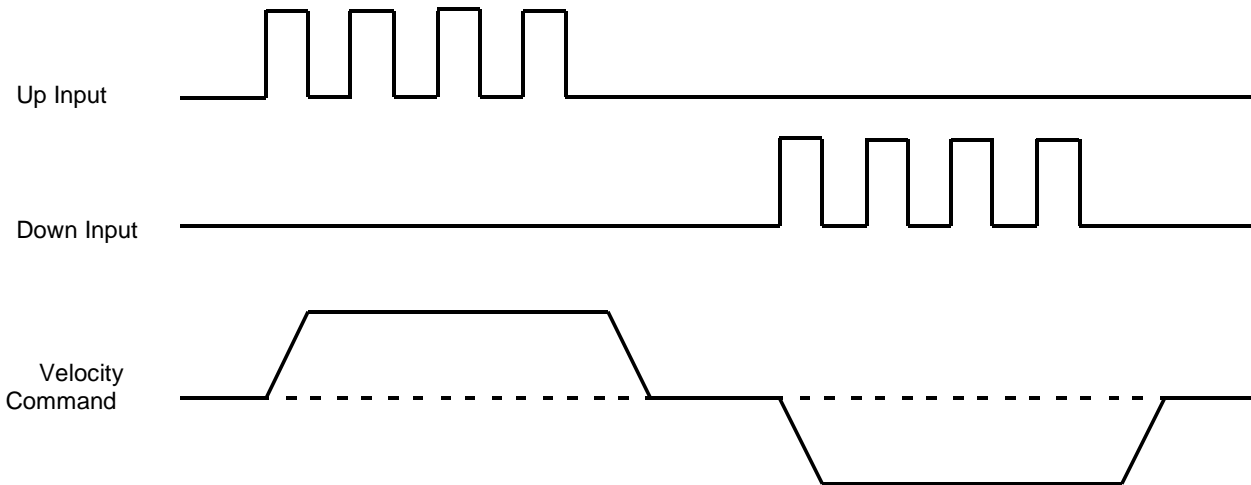

The amplifier can be set to increment position on the rising or falling edge of the signal. Stepping resolution can be programmed for electronic gearing.

Quadrature Format

In quadrature format, A/B quadrature commands from a master encoder (via two inputs) provide velocity and direction commands, as shown below.

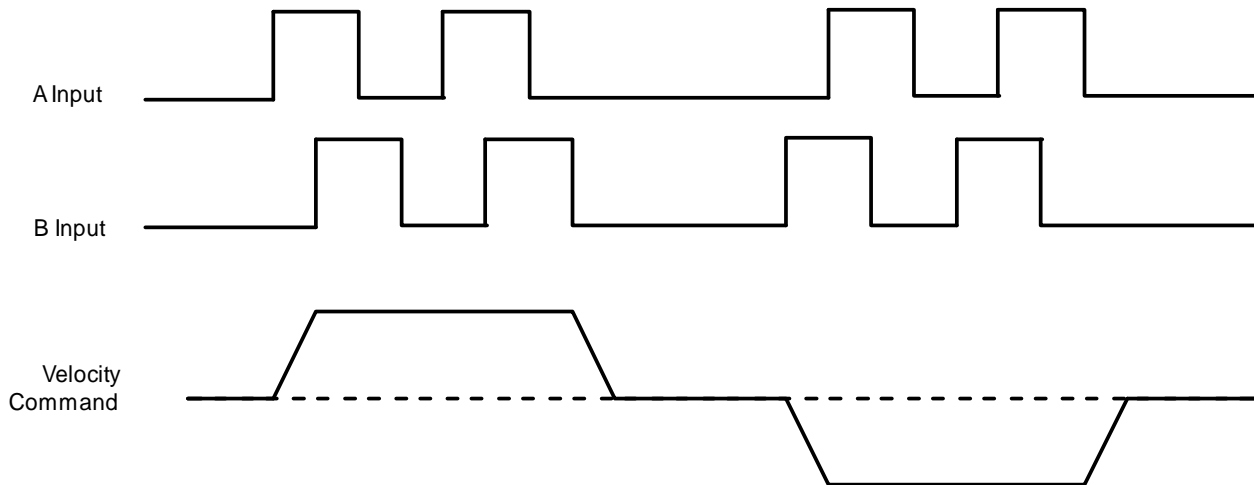

The ratio can be programmed for electronic gearing.

2.5.9: CVM Program

The Copley Virtual Machine (CVM) is a software program that runs motion control programs on supported Copley Controls amplifiers. When a CVM program is running, the amplifier can receive input commands from the CVM program.

For more information, see the *Copley Indexer Program User's Guide*.

2.6: CANopen Operation

2.6.1: CAN Network and CANopen Profiles for Motion

In position mode, the amplifier can take instruction over a two-wire Controller Area Network (CAN). CAN specifies the data link and physical connection layers of a fast, reliable network.

CANopen is a set of profiles (specifications) built on a subset of the CAN application layer protocol. These profiles specify how various types of devices, including motion control devices, can use the CAN network in a highly efficient manner. Xenus supports the relevant CANopen profiles, allowing it to operate in the following modes of operation: profile torque, profile velocity, profile position, interpolated position, and homing.

2.6.2: Supported CANopen Modes

In profile torque mode, the amplifier is programmed with a torque command. When the amplifier is enabled, or the torque command is changed, the motor torque ramps to the new value at a programmable rate. When the amplifier is halted, the torque ramps down at the same rate.

In profile velocity mode, the amplifier is programmed with a velocity, a direction, and acceleration and deceleration rates. When the amplifier is enabled, the motor accelerates to the set velocity and continues at that speed. When the amplifier is halted, the velocity decelerates to zero.

In profile position mode, the amplifier is programmed with a velocity, a relative distance or absolute position, and acceleration and deceleration rates. On command, a complete motion profile is executed, traveling the programmed distance or ending at the programmed position. The amplifier supports both trapezoidal and s-curve profiles.

In PVT mode, the controller sends the amplifier a sequence of points, each of which is a segment of a larger, more complex move, rather than a single index or profile. The amplifier then uses cubic polynomial interpolation to “connect the dots” so that the motor reaches each point at the specified velocity at the programmed time.

Homing mode is used to move the axis from an unknown position to a known reference or zero point with respect to the mechanical system. The homing mode is configurable to work with a variety of combinations of encoder index, home switch, and limit switches.

2.6.3: Architecture

As shown below, in a CANopen motion control system, control loops are closed on the individual amplifiers, not across the network. A master application coordinates multiple devices, using the network to transmit commands and receive status information. Each device can transmit to the master or any other device on the network. CANopen provides the protocol for mapping device and master internal commands to messages that can be shared across the network.

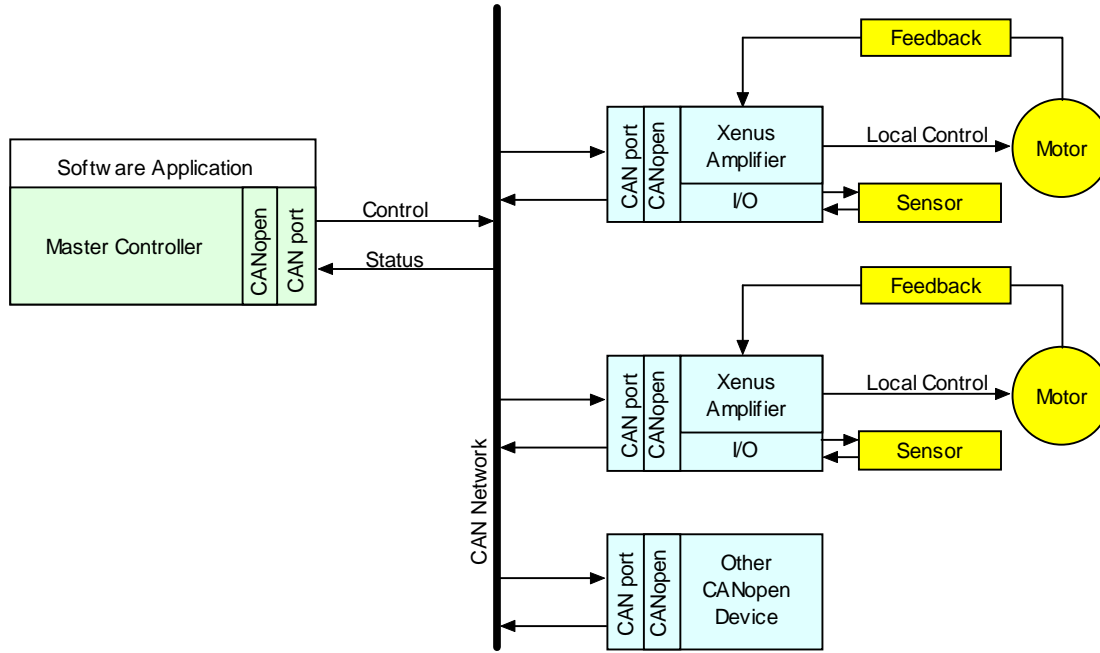

2.6.4: CAN Addressing

A CANopen network can support up to 127 nodes. Each node must have a unique and valid seven-bit address (Node ID) in the range of 1-127. (Address 0 is reserved and should only be used when the amplifier is serving as a CME 2 serial port multi-drop gateway.)

There are several basic methods for setting the CAN address, as described below. These method can be used in any combination, producing a CAN address equal to the sum of the settings.

Addressing Method	Description
Use switch	If the address number <= 15, CAN address can be set using the CAN ADDR switch only.
Use inputs	Use the amplifier's programmable digital inputs (user selects how many (1-7) and which inputs are used).
Use programmed value	Program address into flash only.

For more information on CAN addressing, see [CAN Interface \(p. 109\)](#).

For more information on CANopen operations, see the following Copley Controls documents:

- *CANopen Programmer's Manual*
- *CML Reference Manual*
- *Copley Motion Objects Programmer's Guide*

2.7: Limit Switches

2.7.1: Use Digital Inputs to Connect Limit Switches

Limit switches help protect the motion system from unintended travel to the mechanical limits. Any of the digital inputs 2-12 can be programmed as positive or negative limit switch inputs. With the amplifier operating as a CAN node, an input can also be programmed as a home limit switch for CANopen homing operations.

2.7.2: Diagram: Sample Placement of Limit Switches

The following diagram shows these limit switches in use on a sample motion stage.

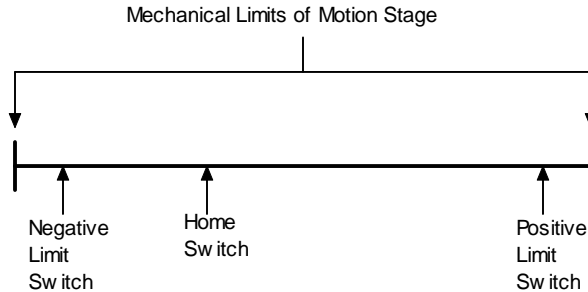

2.7.3: How the Amplifier Responds to Limit Switch Activation

The amplifier stops any motion in the direction of an active limit switch, as described below. The response is identical in current and velocity modes, and slightly different in position mode.

Mode	Amplifier Response to Active Positive (or Negative) Limit Switch
Current	Amplifier prohibits travel in positive (or negative) direction. Travel in the opposite direction is still allowed.
Velocity	Amplifier status indicator flashes green at fast rate. Warning is displayed on CME 2 Control Panel and CME 2 Control Panel limit indicator turns red.
Position	Amplifier stops responding to position commands until the amplifier is disabled and re-enabled, or the fault is cleared over the CANopen interface. Amplifier status indicator flashes green at fast rate. Warning is displayed on CME 2 Control Panel and CME 2 Control Panel limit indicator turns red. Default behavior: If, after re-enabling the amp, the limit switch is still active, the amplifier will only allow movement in the opposite direction. “Hold position” behavior: If the *Hold position when limit switch is active option is set, the amplifier prevents any motion while a limit switch is active. CAUTION: If the amplifier is switched back to current or velocity mode with this option selected, the limit switches will no longer function. For more information on *Hold position when limit switch is active , see Digital Inputs (p. 93) .

2.7.4: Using Custom Output to Signal Limit Switch Activation

In addition to the response described above, any of the amplifier’s digital outputs can be configured to go active when a positive or negative limit switch is activated. For more information, see [Custom Digital Output Settings: Custom Event \(p. 96\)](#).

2.8: Brake Operation

2.8.1: Digital Output Controls Brake

Many control systems employ a brake to hold the axis when the amplifier is disabled. Digital output 4 (OUT4) is designed specifically for a brake output. (Other outputs can be used for brake control, but OUT4 is recommended.) Unlike the other outputs, OUT4 is optically isolated from the control signals and has an internal fly back diode connected to the +24 Vdc input. By eliminating the need to connect into the amplifier control connector, having the brake output on the +24 Vdc power connector simplifies wiring when the brake wires are in the power cable of the motor.

For more information, see [Brake Output \(p. 47\)](#) and [Logic Supply / Brake \(J4\) \(p. 60\)](#).

2.8.2: Brake/Stop Sequences

Disabling the amplifier by a hardware or software command starts the following sequence of events.

- The motor begins to decelerate (at *Abort Deceleration* rate in position mode or *Fast Stop Ramp* rate in velocity mode). At the same time, the *Brake/Stop Delay Time* count begins. This allows the amplifier to slow the motor before applying the brake.
- When the motor slows to *Brake/Stop Activation Velocity* OR the *Brake/Stop Delay Time* expires, the brake output activates and *PWM Delay Brake/Stop Response Time* count begins.
- When response time has passed, the amplifier's output stages are disabled. This delay ensures the brake has time to lock in before disabling the power section.

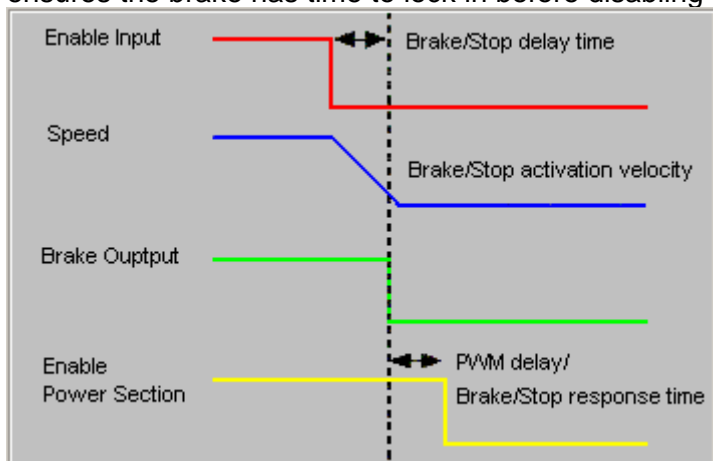

This sequence is not available in the current mode of operation. Instead, in current mode, the amplifier output turns off and the brake output activates immediately when the disable command is received.

2.9: Status Indicators

2.9.1: Amplifier and CAN Interface Status Indicators

The amplifier's status indicator is a bicolor LED labeled STATUS on the amplifier front panel. The CAN interface status indicator is a bicolor LED labeled CAN. Locations are shown below.

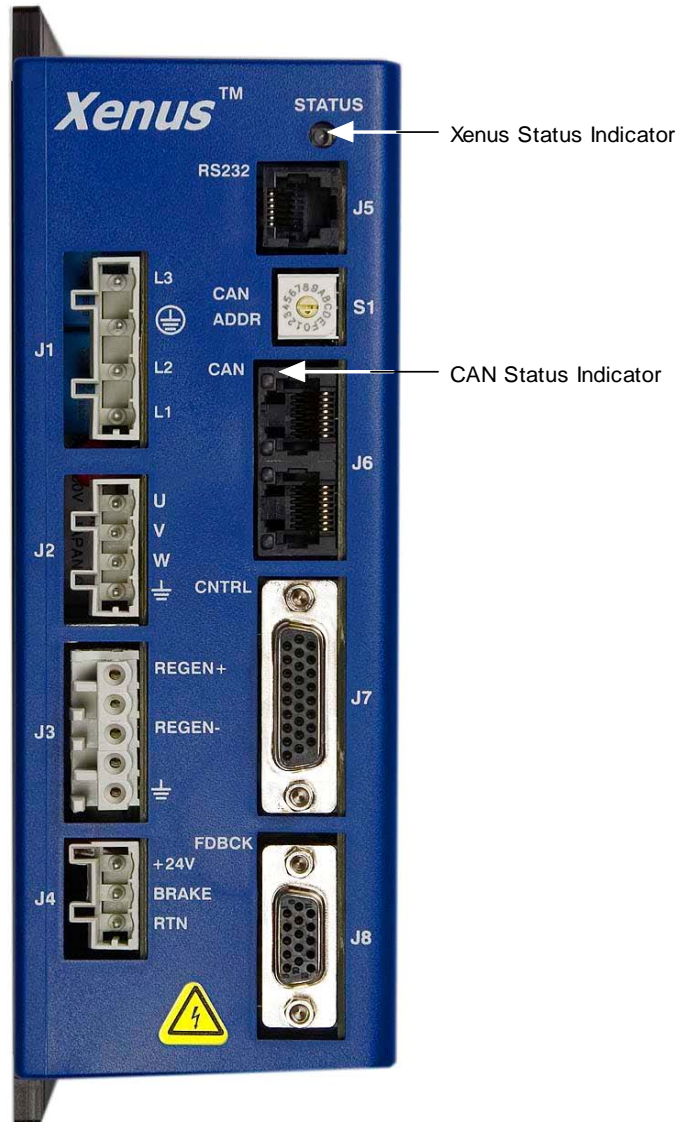

2.9.2: Amplifier Status Indicator Operation

Amplifier status indicator color/blink codes are described below.

Color/Blink Code	Meaning
Not illuminated	No +24 Vdc power to amplifier.
Steady green	Amplifier is enabled and operational.
Slow-blinking green	Amplifier is disabled. No faults or warnings are active.
Fast-blinking green	A limit switch is active. The amplifier is enabled.
Steady red	A non-latched fault has occurred.
Blinking red	A latched fault has occurred.

2.9.3: CAN Interface Status Indicator Operation

The amplifier status indicator color/blink codes comply with CAN Indicator Specification 303-3 as described below. Note that green and red codes are often interlaced, each indicating a different set of conditions. The green codes indicate the CANopen state machine mode of operation (pre-operational, operational, or stopped). The red codes indicate the status of the physical bus (warning or error conditions).

CANopen State Machine Mode of Operation		
Indicator	State	Diagram
Blinking green	Pre-operational.	
Steady green	Operational	
Single flash green	Stopped	

Physical Bus Status		
Single flash red	Warning Limit Reached	
Double flash red	Error Control Event	
Triple flash red	Sync Error	
Steady red	Bus Off	

In addition, the CAN status indicator is turned off when the CAN node ID selector (CAN ADDR) is set to 0. A setting of 0, which is invalid, shuts down most operations on the CAN interface, and the light is shut off to indicate this status.

2.10: Protection

2.10.1: Faults

Overview

Xenus detects and responds to a set of conditions regarded as faults, such as amplifier over temperature and excessive following error. When any fault occurs, with the exception of a following error, the amplifier's PWM output stage is disabled, the fault type is recorded in the amplifier's internal error log (which can be viewed with CME 2), and the status LED changes to indicate a fault condition exists. A digital output can also be programmed to activate on a fault condition. The following error fault behaves with slight differences, as described in [Following Error Fault Details \(p. 37\)](#).

The amplifier's PWM output stage can be re-enabled after the fault condition is corrected and the amplifier faults are cleared. The process for clearing faults varies depending on whether the fault is configured as non-latched or latched.

The fault-clearing descriptions below apply to all faults except for the following error fault, which is described in [Following Error Fault Details \(p. 37\)](#).

Clearing Non-Latched Faults

The amplifier clears a non-latched fault, without operator intervention, as soon as the fault condition is corrected.



DANGER

Risk of unexpected motion with non-latched faults.

After the cause of a non-latched fault is corrected, the amplifier re-enables the PWM output stage without operator intervention. In this case, motion may re-start unexpectedly. Configure faults as latched unless a specific situation calls for non-latched behavior. When using non-latched faults, be sure to safeguard against unexpected motion.

Failure to heed this warning can cause equipment damage, injury, or death.

Clearing Latched Faults

A latched fault is cleared only after the fault has been corrected and at least one of the following actions has been taken:

- power-cycle the +24 Vdc to the amplifier
- cycle (disable and then enable) an enable input that is configured as *Enables with Clear Faults* or *Enables with Reset*
-  access the CME 2 *Control Panel* and press **Clear Faults** or **Reset**
- clear the fault over the CANopen network or serial bus

Example: Non-Latched vs. Latched Faults

For example, the amplifier temperature reaches the fault temperature level and the amplifier reports the fault and disables the PWM output. Then, the amplifier temperature is brought back into operating range. If the *Amplifier Over Temperature* fault is not latched, the fault is automatically cleared and the amplifier's PWM outputs are enabled. If the fault is latched, the fault remains active and the amplifier's PWM outputs remain disabled until the faults are specifically cleared (as described above).

Fault Descriptions

The set of possible faults is described below. For details on limits and ranges, see [Fault Levels \(p. 49\)](#).

Fault Description	Fault Occurs When...	Fault is Corrected When...
*Amplifier Over Temperature	Amplifier's internal temperature exceeds specified temperature.	Power module temperature falls below specified temperature.
Motor Phasing Error	Encoder-based phase angle does not agree with Hall switch states. This fault can occur only with brushless motors set up using sinusoidal commutation. It does not occur with resolver feedback or with Halls correction turned off.	Encoder-based phase angle agrees with Hall switch states.
*Feedback error	Over current condition detected on the output of the internal +5 Vdc supply used to power the feedback. Resolver or analog encoder not connected or levels out of tolerance.	Encoder power returns to specified voltage range. Feedback signals stay within specified levels.
*Motor Over Temperature	Motor over-temperature switch changes state to indicate an over-temperature condition.	Temperature switch changes back to normal operating state.
Under Voltage	Bus voltage falls below specified voltage limit.	+ DC bus voltage returns to specified voltage range.
Over Voltage	Bus voltage exceeds specified voltage limit.	+ DC bus voltage returns to specified voltage range.
*Following Error	User set following error threshold exceeded.	See Position and Velocity Errors (p. 36) .
*Short Circuit Detected	Output to output, output to ground, internal PWM bridge fault.	Short circuit has been removed.
Over Current (Latched)	Output current I^2T limit has been exceeded.	Amplifier is reset and re-enabled.
*Latched by default.		

2.11: Position and Velocity Errors

2.11.1: Error-Handling Methods

In position mode, any difference between the limited position output of the trajectory generator and the actual motor position is a position error. The amplifier's position loop uses complementary methods for handling position errors: following error fault, following error warning, and a position-tracking window.

Likewise, in velocity or position mode, any difference between the limited velocity command and actual velocity is a velocity error. The amplifier's velocity loop uses a velocity tracking window method to handle velocity errors. (There is no velocity error fault.)

2.11.2: Following Error Faults

When the position error reaches the programmed *fault* threshold, the amplifier immediately faults. (The following error fault can be disabled.)

For detailed information, see [Following Error Fault Details \(p. 37\)](#).

2.11.3: Following Error Warnings

When the position error reaches the programmed *warning* threshold, the amplifier immediately sets the *following error warning bit* in the status word. This bit can be read over the CAN network. It can also be used to activate a digital output.

2.11.4: Position and Velocity Tracking Windows

When the position error exceeds the programmed *tracking window* value, a status word bit is set. The bit is not reset until the position error remains within the tracking window for the programmed *tracking time*.

A similar method is used to handle velocity errors.

For detailed information, see [Tracking Window Details \(p. 38\)](#).

2.11.5: Following Error Fault Details

Position Error Reaches Fault Level

As described earlier, position error is the difference between the limited position output of the trajectory generator and the actual position. When position error reaches the programmed *Following Error Fault* level, the amplifier faults (unless the following error fault is disabled.) As with a warning, a status bit is set. In addition, the fault is recorded in the error log.

Additional responses and considerations depend on whether the fault is non-latched or latched, as described below.

Amplifier Response to Non-Latched Following Error Fault

When a non-latched following error fault occurs, the amplifier drops into velocity mode and applies the *Fast Stop Ramp* deceleration rate to bring the motor to a halt. The amplifier PWM output stage remains enabled, and the amplifier holds the velocity at zero, using the velocity loop.

Resuming Operations After a Non-Latched Following Error Fault

The clearing of a non-latched following error depends on the amplifier's mode of operation. Issuing a new trajectory command over the CAN bus, the ASCII interface, or DeviceNet will clear the fault and return the amplifier to normal operating condition.

If the amplifier is receiving position commands from the digital or differential inputs, then the amplifier must be disabled and then re-enabled using the amplifier's enable input or through software commands. After re-enabling, the amplifier will operate normally.

Amplifier Response to a Latched Following Error Fault

When a latched following error fault occurs, the amplifier disables the output PWM stage without first attempting to apply a deceleration rate.

Resuming Operations After a Latched Following Error Fault

A latched following error fault can be cleared using the steps used to clear other latched faults:

- power-cycle the +24 Vdc to the amplifier
- cycle (disable and then enable) an enable input that is configured as *Enables with Clear Faults* or *Enables with Reset*
-  access the CME 2 *Control Panel* and press **Clear Faults** or **Reset**
- clear the fault over the CANopen network or serial bus

2.11.6: Tracking Window Details

Proper Tracking Over Time

As described earlier, position error is the difference between the limited position output of the trajectory generator and the actual position. Velocity error is the difference between commanded and actual velocity.

When the position or velocity error exceeds the programmed *tracking window* value, a status word bit is set. The bit is not reset until the error remains within the tracking window for the programmed *tracking time*.

Velocity Tracking Illustration

The following diagram illustrates the use of tracking window and time settings in velocity mode.

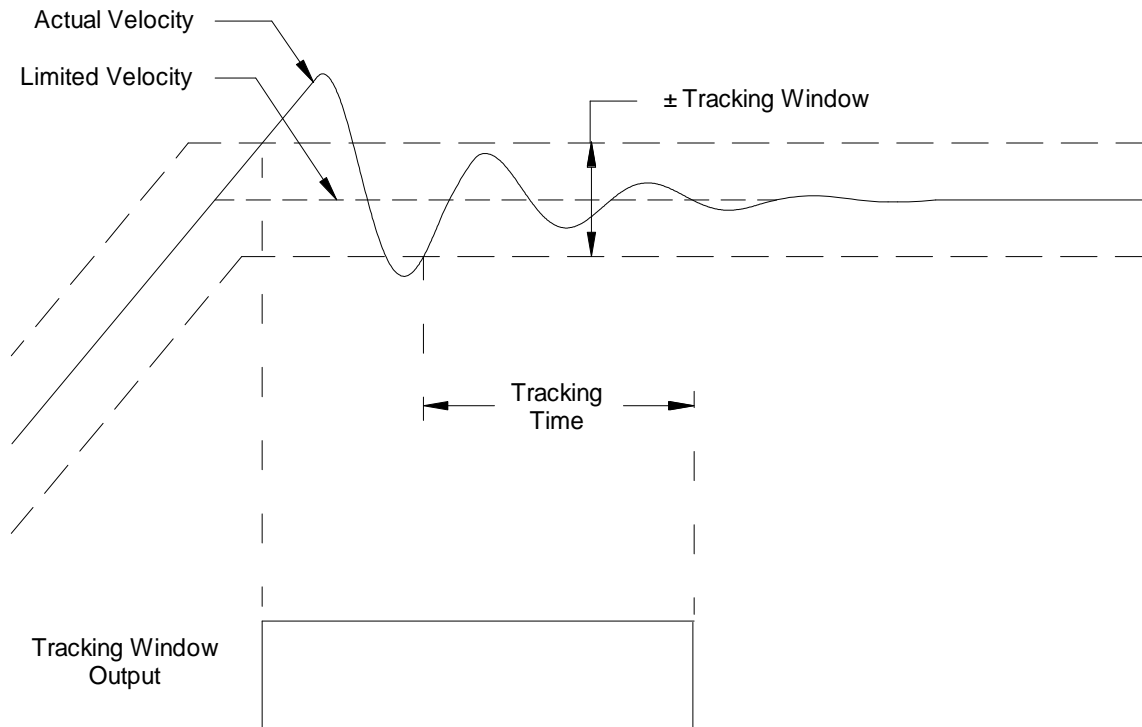

2.12: Communication

2.12.1: Communication Interfaces

As described below, the amplifier features two communication interfaces, each used for different purposes.

Interface	Description
RS-232 port	<p>The amplifier features a three-wire RS-232 port. CME 2 software communicates with the amplifier using a binary protocol over this link for commissioning, adjustments, and diagnostics. In addition, ASCII commands can be issued over the serial port. For RS-232 port specifications, see Serial Interface (p. 49). For RS-232 port wiring instructions, see RS-232 Serial Communications (J5) (p. 61).</p> <p>In an RS-232 multi-drop configuration, a single amplifier with a serial connection to a controller can act as a gateway. Through the gateway amplifier, the controller can use the serial connection to access other amplifiers on the CAN bus.</p> <p>CME 2 can be used over a direct RS-232 connection to make adjustments and monitor operations even when the amplifier is being controlled over the CAN interface or by the digital inputs.</p>
CAN interface	<p>When operating as a CANopen or DeviceNet node, the amplifier takes input commands over a CAN bus. CAN communications are described in CME 2 and CAN Operation (p. 39). DeviceNet is described in the <i>Copley DeviceNet Programmer's Guide</i>.</p>

2.12.2: CME 2 and CAN Operation

When the amplifier is operated as a CANopen or DeviceNet node, CME 2 can be used for programming before and after installation in a CAN network.

CME 2 can also monitor operations while the amplifier is operating as a CANopen or DeviceNet node.

If CME 2 is used to initiate any movement (using the Control Panel Jog feature or a scope function), the amplifier's CANopen or DeviceNet operations are suspended. When adjustments are complete, CME 2 relinquishes returns the amplifier to the CANopen or DeviceNet node state.



DANGER

Using CME 2 can affect or suspend CAN operations.

When operating the amplifier as a CANopen or DeviceNet node, use of CME 2 to change amplifier parameters can affect CANopen or DeviceNet operations in progress.

Using CME 2 to initiate motion can cause CANopen operations to suspend. The operations may restart unexpectedly when the CME 2 move is stopped.

Failure to heed this warning can cause equipment damage, injury, or death.

2.13: Inputs

2.13.1: Digital Inputs

The amplifier has twelve digital inputs (IN1-IN12). Eleven of them appear on the control connector. IN5 appears on the feedback connector, and is intended for the motor over temperature switch (although it can be programmed for any function). For a list of input functions, see [Digital Input Functions \(p. 94\)](#).

2.13.2: Input Filters

Two types of input RC filters are used: GP (general-purpose) and HS (high-speed). Input reference functions such as Pulse and Direction, Pulse Up/Pulse Down, and Quadrature A/B are wired to inputs that have the HS filters, and inputs with the GP filters are used for general-purpose logic functions, limit switches, and the motor temperature sensor.

2.13.3: Debounce Time

To prevent undesired multiple triggering caused by switch bounce upon switch closures, each input can be programmed with a debounce time. The programmed time specifies how long an input must remain stable at a new state before the amplifier recognizes the state. The debounce time is ignored if the input is used as a digital command input.

2.13.4: Configure for Pull Up/Pull Down Resistors by Groups

Pre-defined groups of inputs can be programmed to have either an internal pull up or pull down resistor. See [J7 Pin Description \(p. 64\)](#) for groupings.

2.14: Outputs

2.14.1: Digital Outputs

The amplifier has four programmable digital outputs. Three of the outputs (OUT1 - 3) are general-purpose outputs. The fourth (OUT4) is specifically designed as a brake output but can be programmed to perform any of the functions. For a list of digital output functions, see [Standard Digital Outputs \(p. 95\)](#).

The general-purpose outputs are open-drain MOSFETs, each with a pull-up resistor, in series with a diode, connected to the amplifier's internal +5 Vdc supply. This design allows the outputs to be directly connected to optically isolated PLC inputs that reference a voltage higher than +5 Vdc, typically +24 Vdc. The diode prevents current flow between the +24 Vdc supply and the internal +5 Vdc supply through the pull-up resistor. This current, if allowed to flow, could turn on the PLC input, giving a false indication of the amplifier's true output state.

The general-purpose outputs require an external fly-back diode to be installed across any inductive loads, such as relays, that are connected to them.

The brake output (OUT4) is described in [Brake Operation \(p. 31\)](#).

2.15: Regen Resistor Theory

2.15.1: Regeneration

When a load is accelerated electrical energy is converted into mechanical energy. During deceleration the conversion is reversed. This is called regeneration. Some of this regenerated energy is lost to friction in the mechanical system. More of this energy is converted to heat due to I^2R losses in the motor windings, cabling, and drive electronics. The remainder of the energy is added to the electrical energy already stored in the internal capacitor bank of the amplifier. The result of this energy being added is an increase in the voltage on the capacitor bank.

2.15.2: Regen Resistor

If too much energy is added to the capacitor bank, the voltage rises to a point where the amplifier's over voltage protection shuts down the amplifier. To prevent this, a regen circuit shunts some of the energy into an external regen resistor when the voltage rises too high.

2.15.3: Regen Circuit Components

The amplifier provides an internal transistor that is used in combination with an external resistor. Copley Controls supplies compatible resistors as described in [Regen Resistor Assemblies \(p. 177\)](#). When using a resistor acquired from another source, be sure it meets the specifications described in [Regen Resistor Sizing and Configuration \(p. 145\)](#).

2.15.4: Regen Circuit Protections

The amplifier protects the regen circuit against short circuit, and uses I^2T peak current/time algorithms to protect both the external resistor and the internal transistor.

2.15.5: Configurable Custom Resistor

The following values can be entered for a custom resistor using CME 2:

Option	Description
Resistance Value	Value in ohms of the resistor
Continuous Power	Continuous power rating of the resistor
Peak Power	Peak power rating of the resistor
Time at Peak Power	Time at peak power of resistor

For more information, see [Regen Resistor \(p. 102\)](#) and [Regen Resistor Sizing and Configuration \(p. 145\)](#)

CHAPTER

3: SPECIFICATIONS

This chapter describes the amplifier specifications. Contents include:

Title	Page
3.1: Agency Approvals.....	44
3.2: Power Input	44
3.3: Power Output.....	44
3.4: Control Loops	45
3.5: Regen Circuit Output	45
3.6: Digital Command Input	45
3.7: Analog Command Input.....	46
3.8: Digital Inputs.....	46
3.9: Digital Outputs	46
3.10: Brake Output	47
3.11: Encoder Power Supply Output.....	47
3.12: Primary Encoder Inputs	47
3.13: Analog Encoder Inputs	47
3.14: Hall Switch Inputs	48
3.15: Resolver Interface	48
3.16: Multi-Mode Port	48
3.17: Serial Interface	49
3.18: CAN Interface.....	49
3.19: Status Indicators.....	49
3.20: Fault Levels	49
3.21: Power Dissipation.....	50
3.22: Thermal Impedance.....	50
3.23: Mechanical and Environmental.....	50
3.24: Dimensions.....	51

3.1: Agency Approvals

- CE Compliance*:
 - EN 55011 Compatibility
 - EN 61000-6-1 Immunity
 - EN 61010-1 Safety
- UL 508C Compliant
- RoHS Compliant

*CE Declaration of Conformity available at

<http://www.copleycontrols.com/Motion/Downloads/xenusData.html>

3.2: Power Input

Model	XTL-230-18 (-R, -S)	XTL-230-36 (-R, -S)	XTL-230-40 (-R, -S)
Mains Voltage	100 - 240 Vac 1 Ø or 3 Ø		
Mains Frequency	47 to 63 Hz		
Mains Current	15 Arms maximum	20 Arms maximum	
Current Inrush	15 A peak at 120 Vac 35 A peak at 240 Vac		
Logic Supply Voltage	+20 to +32 Vdc		
Logic Supply Current	500 mA maximum		

3.3: Power Output

Model	XTL-230-18 (-R, -S)	XTL-230-36 (-R, -S)	XTL-230-40 (-R, -S)
Peak Current	18 Adc [12.7 Arms]	36 Adc [25.5 Arms]	40 Adc [28.3 Arms]
Peak Current Time	1 Second		
Continuous Current*	6 Adc [4.24 Arms]	12 Adc [8.5 Arms]	20 Adc [14.1 Arms]
Efficiency	>97% @ 230 Vac and rated continuous current		
Output Type	3-phase IGBT inverter 15 kHz center-weighted PWM space-vector modulation		
PWM Ripple Frequency	30 kHz		
Minimum Load Inductance	400 uH line-to-line** NOTE: See Xenus Filter (p. 163) .		
* Heat sinking and/or forced air cooling required for continuous output power rating			
** Consult factory for operation with inductance lower than 400 uH			

3.4: Control Loops

Type	Current Velocity Position	100% digital.
Sampling rate (time)	Current Velocity Position	15 kHz (67 μ s) 3 kHz (333 μ s) 3 kHz (333 μ s)
Current Loop Small Signal Bandwidth		> 2 kHz (Tuning and load impedance dependent)
Velocity Loop Filters	Type	Programmable Low Pass, 1 Pole Low Pass, Butterworth, 2 Poles Bi-Quadratic, 2 Poles & 2 Zeros
	Frequency Range	Programmable 20 - 1500 Hz
Bus Voltage Compensation		Changes in bus or mains voltage do not affect tuning.

3.5: Regen Circuit Output

Model	XTL-230-18 (-R, -S)	XTL-230-36 (-R, -S)	XTL-230-40 (-R, -S)
Continuous Power	2 kW		4 kW
Peak Power	5 kW		10 kW
Minimum Resistance	30 Ω		15 Ω
Minimum Resistor Wattage	25 W		50 W
Turn On Voltage	+390 Vdc		
Turn Off Voltage	+380 Vdc		
DC Bus Capacitance	1760 μ F nominal		
Regen Energy Absorption Capacity			
Input Voltage 120 Vac	108 joules		
208 Vac	57 joules		
240 Vac	32 joules		

3.6: Digital Command Input

Digital Position Command	Pulse and direction, Count up/ count down maximum rate	2 MHz (with active driver)
	Quadrature A/B encoder maximum rate	2 M line/sec (8 M count/sec after quadrature)
Digital Current & Velocity Command	PWM frequency range	1 kHz - 100 kHz
	PWM minimum pulse width	220 nSec

3.7: Analog Command Input

Channels	1
Type	Differential, non-isolated
Measurement Range	± 10 Vdc
Maximum Voltage	± 10 Vdc
Differential Input to Ground	± 10 Vdc
Input Impedance	66 k Ω
Resolution	12 Bit
Bandwidth	7 kHz
Scan Time	67 μ Sec
Function	Current, velocity, or position command

3.8: Digital Inputs

Channels	12* 7 general-purpose 5 high-speed
Type	74HC14 Schmitt trigger w/ RC filter 10 k Ω resistor programmable as pull up or pull down to internal +5 Vdc.
Input Voltage Range	General-Purpose 0 V - +28 Vdc High-speed 0 V - +12 Vdc
Logic Low Input Voltage	< +1.35 Vdc
Logic High Input Voltage	> +3.65 Vdc
Scan Time	333 μ Sec
RC Filter Time Constant	General-Purpose 330 μ Sec High-speed 100 nSec
Debounce	Type Digital Time Programmable 0 - 10,000 mSec
Function	IN1 enable IN2 - IN12 programmable
Note: Inputs 7&9 and 8&10 can be programmed to function as differential pairs.	

3.9: Digital Outputs

Channels	3
Type	Current-sinking MOSFET, non-isolated 1 k Ω pullup to internal +5 Vdc through diode
Maximum Voltage	+40 Vdc
Maximum Sink Current	1 A
Low Level Output Resistance	<0.2 Ω
Function	Programmable

3.10: Brake Output

Channels	1
Type	Current-sinking MOSFET, optically isolated from control/logic ground. Referenced to +24 Vdc logic supply. Internal fly back diode to +24 Vdc.
Maximum Sink Current	1 A
Low Level Output Resistance	<0.2 Ω
Function	Primary function is brake control. May be programmed to other functions.

3.11: Encoder Power Supply Output

Voltage Output	+5 Vdc \pm 2%
Maximum Current Output	400 mA
Short Circuit Protection	Fold-back current limiting
Function	Provides power for motor encoder and/or Hall switches.

3.12: Primary Encoder Inputs

Channels	3
Type	Differential RS-422 line receiver w/ RC filter Non-isolated
Signals	A, /A, B, /B, X*, /X*
Input Voltage Range	\pm 7 Vdc
Differential Input Threshold	\pm 0.2 Vdc
Termination Resistance	121 Ω
Maximum Frequency	5 MHz Line (20 Mcount/sec)
Function	Incremental or analog encoder or resolver required for sinusoidal commutation and position or velocity modes of operation.
* X is equivalent to Marker, Index, or Z channels, depending on the encoder manufacturer. This channel is only required in certain homing modes while under CAN control.	

3.13: Analog Encoder Inputs

Channels	2
Type	Differential, non-isolated
Signals	Sin, cosine
Nominal Voltage	1 Vdc-pk
Maximum Voltage	Differential \pm 0.6 Vdc Input to Ground 0 to +3.5 Vdc
Differential Input Impedance	121 Ω
Bandwidth	230 kHz
Interpolation	1 to 1024, programmable
Function	Incremental or analog encoder or resolver required for sinusoidal commutation and position or velocity modes of operation.

3.14: Hall Switch Inputs

Channels	3
Type	74HC14 Schmitt trigger w/ RC Filter 10 k Ω pull up resistor to internal +5 Vdc
Input Voltage Range	0 Vdc - +28 Vdc
Low Level Input Voltage	< +1.35 Vdc
High Level Input Voltage	> +3.65 Vdc
Scan Time	67 μ Sec
RC Filter Time Constant	33 μ Sec
Function	Commutation of brushless motors in trapezoidal mode. Commutation initialization and phase error detection in sinusoidal mode.

3.15: Resolver Interface

Type	Transmit, 1:1 to 2:1 transformation ratio
Resolution	14 bits (equivalent to a 4096 line quadrature encoder)
Reference Frequency	7.5 kHz
Reference Voltage	3 Vrms, auto-adjustable by amplifier for proper feedback levels.
Reference Max Current	100 mA
Max RPM	10,000
Function	Incremental or analog encoder or resolver required for sinusoidal commutation and position or velocity modes of operation.

3.16: Multi-Mode Port

Channels	3
Type	Bi-Directional, Differential RS-422 Non-isolated
Signals	A, /A, B, /B, X, /X
Input Voltage Range	\pm 7 Vdc
Differential Input Threshold	\pm 0.2 Vdc
Termination Resistance	None
Function Programmable	Output Mode Buffered primary incremental encoder Emulated incremental encoder from analog encoder or resolver Input Mode Secondary incremental encoder input Current / Velocity mode, PWM input Position Mode, Digital command input
Maximum Frequency Output Mode Buffered Encoder Emulated Encoder Input Mode PWM Input Digital Command Secondary Encoder	 5 MHz Line (20 Mcount/sec) 4.5 MHz Line (18 Mcount/sec) 100Khz 5 MHz (50% Duty Cycle) 5 MHz Line (20 Mcount/sec)

3.17: Serial Interface

Channels	1
Type	RS-232
Signals	Rxd, Txd, Gnd
Baud Rate	9,600 to 115,200 (defaults to 9600 on power up or reset)
Data Format	N, 8, 1
Flow Control	None
Protocol	Binary or ASCII format
Function	Set up, control and diagnostics status

3.18: CAN Interface

Channels	1
Connectors	2 eight-position modular (RJ-45 style) wired as per CAN Cia DR-303-1, V1.1 One connector for signal input. Second connector for daisy chaining to next node.
Signals	CAN H, CAN L, CAN Gnd (CAN +5 Vdc Pass though only)
Format	CAN V2.0b physical layer for high-speed connections compliant
Protocol	Motion Control Device Under DSP-402 of the CANopen DS-301 V4.01 (EN 50325-4) Application Layer
Supported Modes	Profile Current, Velocity, and Position, PVT, and Homing
Node Address Selection	16-position rotary switch on front panel OR programmable digital inputs OR stored in flash memory OR combination of above.
Bus Termination	External 121 Ω resistor across CAN-H and CAN-L when termination plug is installed in second connector.
Function	Real-time motion control

3.19: Status Indicators

Amplifier Status	Bi-Color LED on front panel, labeled <i>Status</i> *
CAN Status	Bi-Color LED on front panel, labeled <i>CAN</i> . Conforms to <i>CAN Indicator Specification CiA DR-303-3</i> *
*For status indicator locations and codes, see Status Indicators (p. 32) .	

3.20: Fault Levels

Amp Over Temperature	> 80 °C
DC Bus Under Voltage	< +60 Vdc
DC Bus Over Voltage	> +400 Vdc
Encoder Power	< +4.25 Vdc

3.21: Power Dissipation

		Model:	XTL-230-18 (-R, -S)	XTL-230-36 (-R, -S)	XTL-230-40 (-R, -S)
Output Power	Mains Voltage				
Maximum Continuous	120 Vac		30 W	55 W	92 W
	240 Vac		40 W	75 W	120 W

Power Dissipation

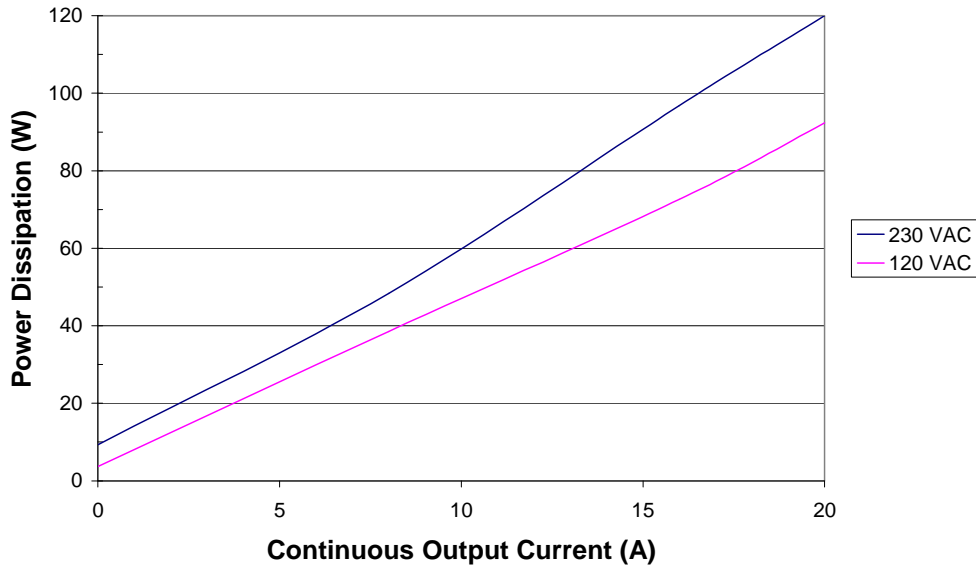

3.22: Thermal Impedance

See [Thermal Considerations](#) (p. 159).

3.23: Mechanical and Environmental

Size	7.55 in (191,8 mm) X 5.57 in (141,5 mm) X 2.57 in (65,3 mm)
Weight	Without Heat Sink 3.0 lb (1.36 kg) With Heat Sink XTL-HL 4.3 lb (1.95 kg) With Heat Sink XTL-HS 4.8 lb (2.20 kg)
Ambient Temperature	Storage -40 to +85°C Operating 0 to +55°C
Humidity	0% to 95%, non-condensing
Contaminants	Pollution degree 2
Environment	IEC68-2: 1990
Cover Material	Meets U.L. Spec 94 V-0 Flammability Rating
Cooling	Heat sink and/or forced air cooling required for continuous power output

3.24: Dimensions

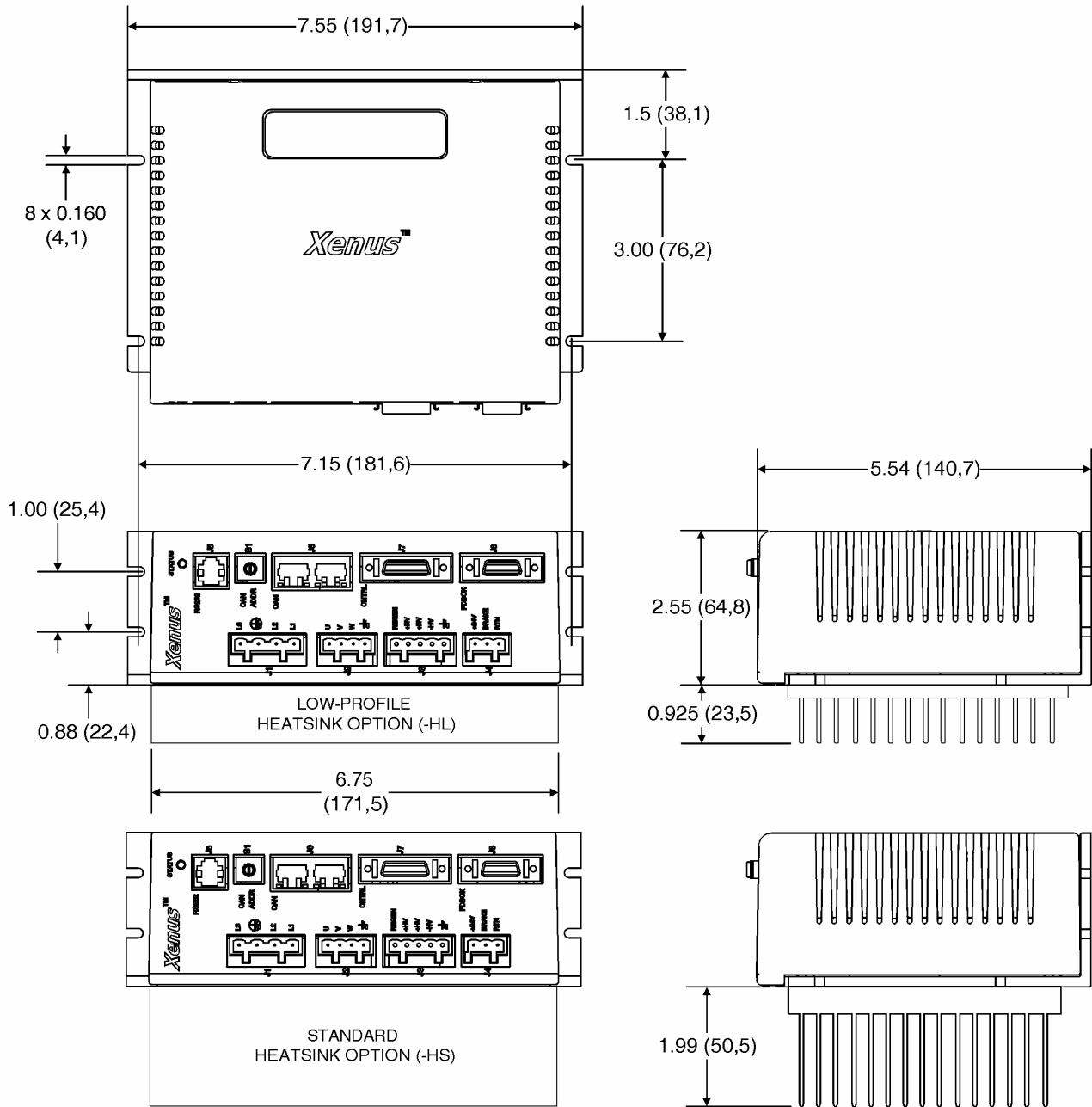

CHAPTER

4: WIRING

This chapter describes the wiring of amplifier and motor connections. Contents include:

Title	Page
4.1: General Wiring Instructions	54
4.2: AC Mains (J1).....	56
4.3: Motor (J2).....	57
4.4: Regen Resistor (J3) (Optional)	59
4.5: Logic Supply / Brake (J4).....	60
4.6: RS-232 Serial Communications (J5).....	61
4.7: CAN Bus (J6)	62
4.8: Control (J7).....	63
4.9: Motor Feedback (J8).....	67

4.1: General Wiring Instructions

4.1.1: Electrical Codes and Warnings

Be sure that all wiring complies with the National Electrical Code (NEC) or its national equivalent, and all prevailing local codes.



DANGER: Hazardous voltages.

Exercise caution when installing and adjusting.

Failure to heed this warning can cause equipment damage, injury, or death.

DANGER



Risk of electric shock.

High-voltage circuits on J1, J2, and J3 are connected to mains power.

Failure to heed this warning can cause equipment damage, injury, or death.

DANGER



Do not ground mains-connected circuits.

With the exception of the ground pins on J1, J2, and J3, all of the other circuits on these connectors are mains-connected and must never be grounded.

Failure to heed this warning can cause equipment damage.

WARNING



Do not plug or unplug connectors with power applied.

The connecting or disconnecting of cables while the amplifier has 24Vdc and/or mains power applied is not recommended.

Failure to heed this warning may cause equipment damage.

WARNING

4.1.2: Grounding Considerations

Primary Grounding Functions

A grounding system has three primary functions: safety, voltage-reference, and shielding.

J1-3 Primary Ground

The primary ground at J1-3 is the safety ground and is intended to carry the fault currents from the mains in the case of an internal failure or short-circuit of electronic components. This ground is connected to the amplifier chassis. Wiring to this ground should be done using the same gauge wire as that used for the mains. This wire is a “bonding” conductor that should be connected to an earthed ground point and must not pass through any circuit interrupting devices.

The pin on the amplifier at J1-3 is longer than the other pins on J1, giving it a first-make, last-break action so that the amplifier chassis is never ungrounded when the mains power is connected.

J2 and J3 Grounds

The ground terminals at J2-1 and J3-5 also connect to the amplifier chassis.

Motor cases can be safety-grounded in one or optionally both of these ways:

- Direct grounding of the motor frame (assuming the frame of the machine is grounded). Attach the metal motor case to the metal machine frame or connect the ground wire of the motor to the metal frame of the machine.
- Grounding of the motor frame through the motor power cable to amplifier J2-1. The ground wire should be of the same gauge as the power wires.

Likewise, the case of the regen resistor can also be safety-grounded by direct grounding of the case or by a grounding wire connected to amplifier J3-5. Again, this wire should be of the same gauge as the other regen resistor conductors.

Cable shields, because of their smaller wire size, must not be used as part of a safety-ground system.

Signal Grounding

The amplifier signal ground must be connected to the control system signal ground. The amplifier signal ground is not connected to earth ground internal to the amplifier. Therefore, the control system signal ground can be connected to earth ground without introducing a ground loop.

Shielding

Shields on cables reduce emissions from the amplifier and help protect internal circuits from interference due to external sources of electrical noise. The shields shown in the wiring diagrams are also required for CE compliance. Cable shields should be tied at both ends to earth or chassis ground. The housing and pin 1 of both J7 and J8 are connected to the amplifier's chassis.

4.1.3: Connector Locations

Connector locations (J1-J8) are shown below.



4.2: AC Mains (J1)

Mating Connector

Description	Euro-style 7,5 mm pluggable female terminal block with preceding ground receptacle.
Manufacturer PN	Wago: 51118287 or 721-204/026-045/RN01-0000
Wire size	22 - 12 AWG
Recommended Wire	18 A models: 14 AWG, 600 V 36 A and 40 A models: 12 AWG, 600 V Shielded cable required for CE compliance
Wire Insertion/Extraction Tool	Wago: 231-131
Connector and tool are included in connector kit XTL-CK or XTL-CA	

Pin Description

Pin	Signal	Function
1	L1	AC power input (hot or L1)
2	L2	AC power input (neutral or L2)
3	Protective ground	Chassis safety ground
4	L3	AC power input (L3)

AC Mains Fuse Recommendation

Recommended fuse type: Class CC, 600 Vac rated, Ferraz-Shawmut ATDR, Littelfuse CCMR, Bussman LP-CC, or equivalent.

AC Mains Wiring Diagram (Single-Phase)

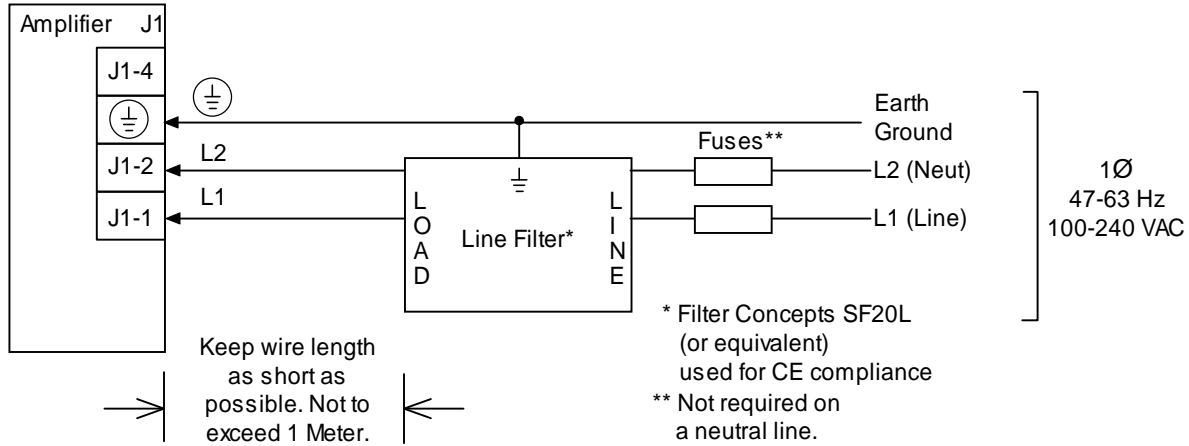

AC Mains Wiring Diagram (Three-Phase)

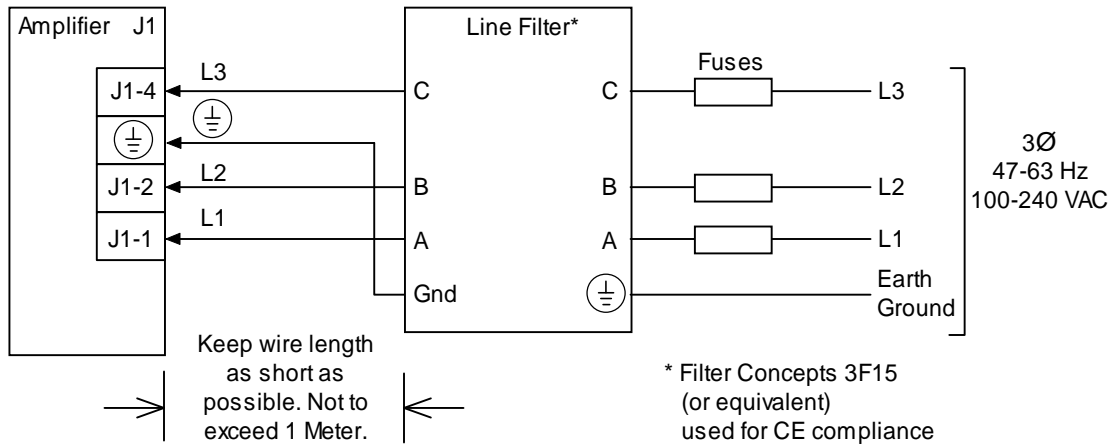

4.3: Motor (J2)

Mating Connector

Description	Euro-style, 4 position, 5.0 mm pluggable female terminal block
Manufacturer PN	Wago: 51118008 or 721-104/026-047/RN01-0000
Wire Size	22 - 12 AWG
Recommended Wire	18 A models: 14 AWG, 600 V 36 A and 40 A models: 12 AWG, 600 V Shielded cable required for CE compliance
Wire Insertion/Extraction Tool	Wago: 231-131
Standard connector and tool are included in connector kit XTL-CK or XTL-CA	

Pin Description

Pin	Signal	Function
1	Ground	Motor frame ground and cable shield
2	W	Phase W output of amplifier
3	V	Phase V output of amplifier (use for DC motor connection)
4	U	Phase U output of amplifier (use for DC motor connection)

Brushless Motor Wiring Diagram

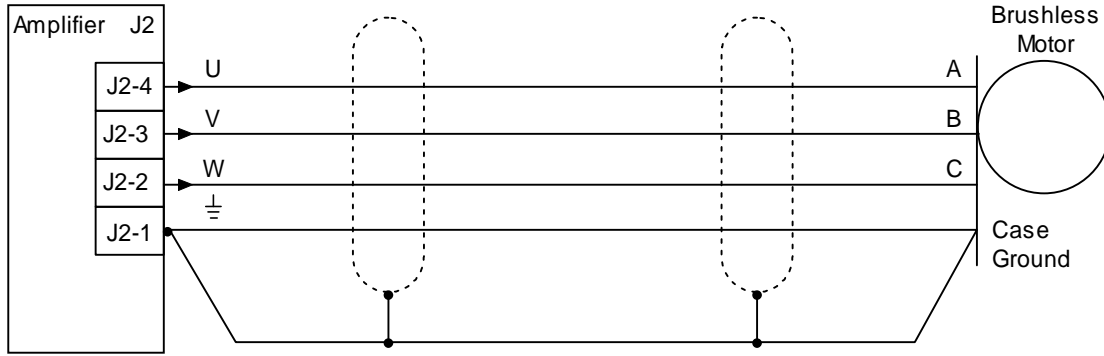

Brush Motor Wiring Diagram

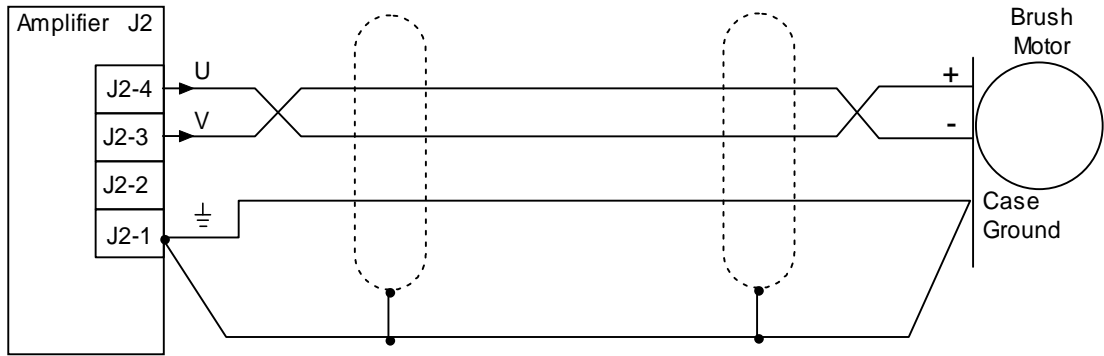

4.4: Regen Resistor (J3) (Optional)

Mating Connector

Description	Euro-style, 5 position, 5.0 mm pluggable male terminal block.
Manufacturer PN	Wago: 51111277 or 721-605/000-043/RNn01-0000
Wire Size	22 - 12 AWG
Recommended Wire	18 A models: 14 AWG, 600 V 36 A and 40 A models: 12 AWG, 600 V Shielded cable required for CE compliance
Wire Insertion/Extraction Tool	Wago: 231-131
Standard connector and tool are included in connector kit XTL-CK or XTL-CA	

Pin Description

Pin	Signal	Function
1	Regen +	+ DC Bus to one side of regen resistor
2	N/C	No connection
3	Regen -	Collector of regen transistor to one side of regen resistor
4	N/C	No connection
5	Ground	Enclosure ground and cable shield

Regen Resistor Wiring Diagram

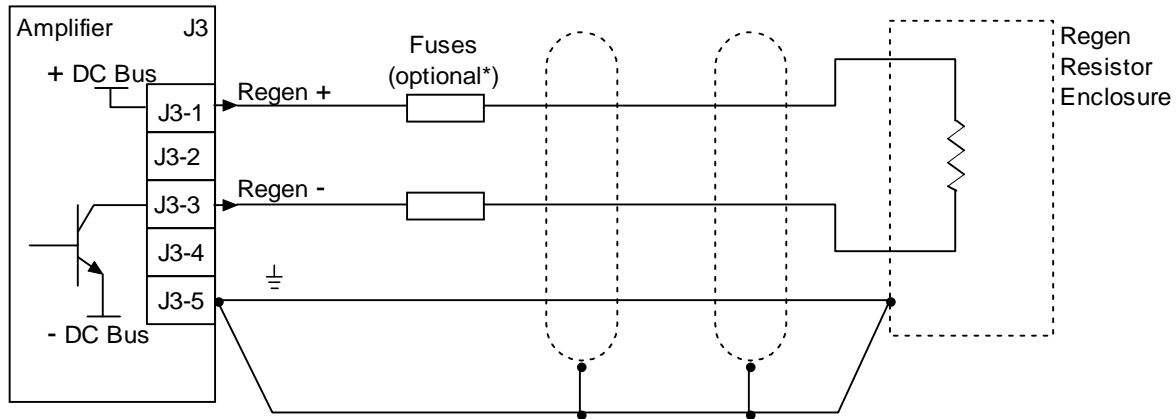

*Fuses may be required by local electrical codes

Regen Resistor Fusing

Recommended Fuses:

Regen Resistor	Fuse type
XTL-RA-03	Cooper Bussman KLM-8, Littelfuse KLKD008, Ferraz Shawmut ATM-10 or equivalent.
XTL-RA-04	Cooper Bussman KLM-12, Littelfuse KLKD012, Ferraz Shawmut ATM-15 or equivalent.
User Supplied	See Regen Resistor Sizing and Configuration (p. 145) .

4.5: Logic Supply / Brake (J4)

Mating Connector

Description	Euro-style, 3 position, 5.0 mm pluggable female terminal block.
Manufacturer PN	Wago: 51117974 or 721-103/026-047/RN01-0000
Wire Size	22 - 14 AWG
Recommended Wire	18 AWG
Wire Insertion/Extraction Tool	Wago: 231-131
Standard connector and tool are included in connector kit XTL-CK or XTL-CA	

Pin Description

Pin	Signal	Function
1	RTN	+24 Vdc return
2	Brake	Return or low side of motor brake
3	+24 Vdc	+24 Vdc Logic power supply

Logic Supply / Brake Wiring Diagram

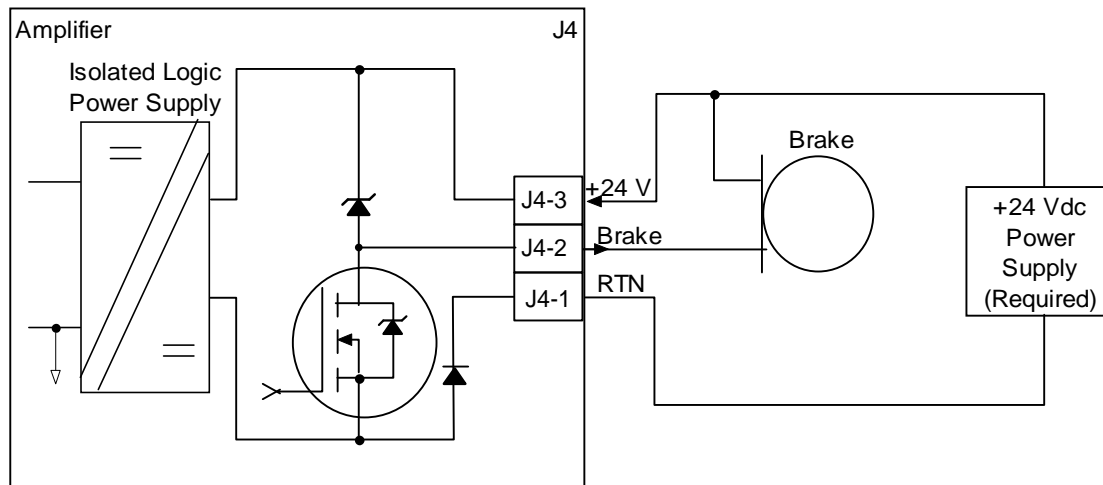

4.6: RS-232 Serial Communications (J5)

Mating Connector

6-position, modular connector (RJ-11 style).

Copley Controls provides a prefabricated cable and modular-to-9-pin sub-D adapter in RS-232 Serial Cable Kit, PN SER-CK.

A diagram of the female connector is shown below.

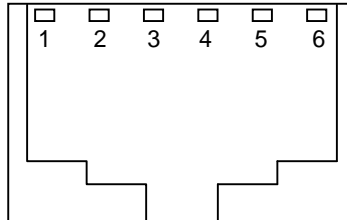

Pin Description

Pin	Signal	Function
1	N/C	No connection
2	RxD	Receive data input from computer
3	Signal ground	Power supply ground
4	Signal ground	Power supply ground
5	TxD	Transmit data output to computer
6	N/C	No connection

RS-232 Serial Communications Wiring Diagram

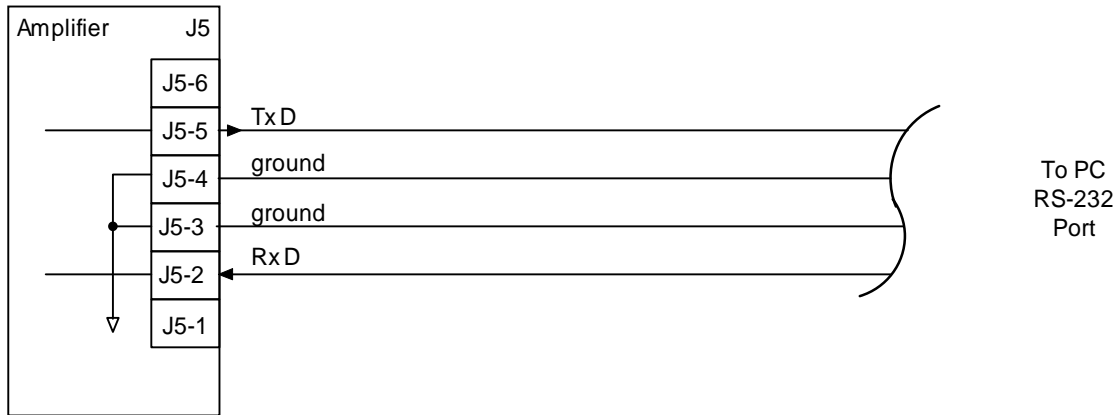

4.7: CAN Bus (J6)

Mating Connector

8-position, modular connector (RJ-45 style). Copley Controls provides the following assemblies:

- Prefabricated 10 foot cable, PN XTL-NC-10
- Prefabricated 1 foot cable, PN XTL-NC-01
- Terminator Plug, PN XTL-NT

A diagram of the female connector is shown below.

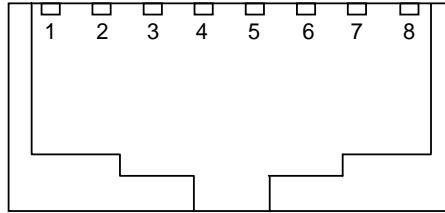

Pin Description*

Pin	Signal	Function
1	CAN_H	CAN_H bus line (dominant high)
2	CAN_L	CAN_L bus line (dominant low)
3	CAN_Gnd	Ground / 0 V / V-
4	--	No connection
5	--	Pass though to second connector, no internal connection
6	CAN_SHLD	Pass though to second connector, no internal connection
7	CAN_Gnd	Ground / 0 V / V-
8	CAN V+	Pass through to second connector, no internal connection

*Table applies to both CAN connectors

CAN Bus Wiring Diagram

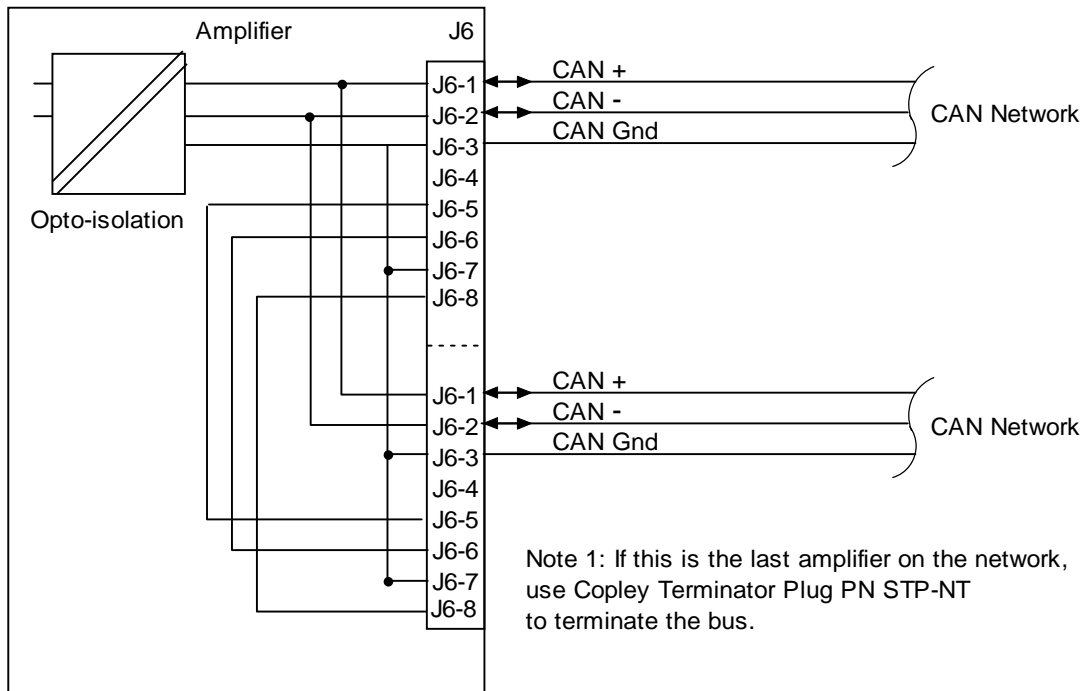

Note 1: If this is the last amplifier on the network, use Copley Terminator Plug PN STP-NT to terminate the bus.

4.8: Control (J7)

Mating Connectors

Description	Manufacturer PN	Wire Size
26 Position, 0.1 x 0.09 High Density D-Sub Male, Solder Style Connector	Norcomp 180-026-103L001	24 - 30 AWG
Back shell	Norcomp 979-015-020R121	
Solder style connector included in Connector Kit PN XTL-CK.		

Pin connections are shown here:

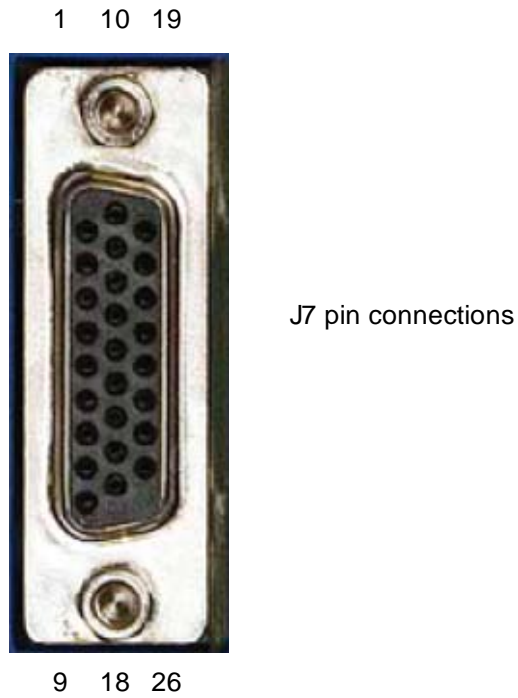

J7 Pin Description

Pin	Signal	Function		
1	Frame Ground	Cable shield connection		
2	Ref - Input	Analog command negative input		
3	Ref + Input	Analog command positive input		
			Speed	Pull-Up/Pull-Down
4	IN1	Enable	Standard	Group 1
5	IN2	Programmable inputs	Standard	Group 1
6	IN3		Standard	Group 1
7	IN4		Standard	Group 2
8	IN11		Standard	Group 4
9	IN12		Standard	Group 4
10	IN6		HS	Group 3
11	IN7	Mode-dependent. See Mode-Dependant Dedicated Inputs (p. 65)	HS	Group 3
12	IN8		HS	Group 3
13	IN9		HS	Group 4
14	IN10		HS	Group 4
15	Signal Ground	Signal ground reference for inputs and outputs		
16	OUT1	Programmable outputs		
17	OUT2			
18	OUT3			
19	Signal Ground	Signal ground for +5Vdc, inputs and outputs		
20	+5 Vdc	+5 Vdc output. Total load current on J7-20, J8-2, and J8-4 not to exceed 400 mA.		
21	Multi-Mode Port /X	Programmable differential input/output port. See Mode-Dependant Dedicated Inputs (p. 65)		
22	Multi-Mode Port X			
23	Multi-Mode Port /B			
24	Multi-Mode Port B			
25	Multi-Mode Port /A			
26	Multi-Mode Port A			

Mode-Dependant Dedicated Inputs

These inputs are dedicated to specific functions, depending on operating mode.

Mode	Selected Command Source			Function
	Digital Input Single Ended	Digital Input Differential	Multi-Mode Port	
Current & Velocity PWM 50%	9	9(+) & 7(-)	A & /A	PWM Input
Current & Velocity PWM 100%	9 10	9(+) & 7(-) 10(+) & 8(-)	A & /A B & /B	PWM Input Direction Input
Position Pulse & Direction	9 10	9(+) & 7(-) 10(+) & 8(-)	A & /A B & /B	Pulse Input Direction Input
Position Up/Down	9 10	9(+) & 7(-) 10(+) & 8(-)	A & /A B & /B	Count Up Count Down
Position Quadrature	9 10	9(+) & 7(-) 10(+) & 8(-)	A & /A B & /B	Channel A Channel B

Digital Inputs Wiring Diagram

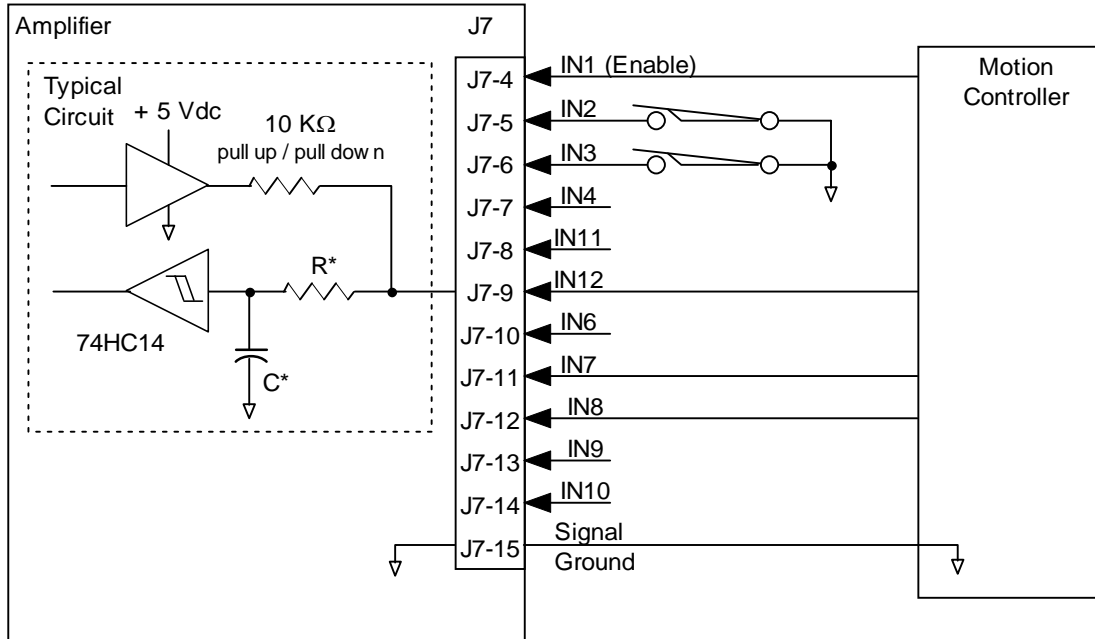

* Standard input R = 10 KΩ C = 0.033 μf
High-speed input R = 1KΩ C = 100 pf

Digital Outputs Wiring Diagram

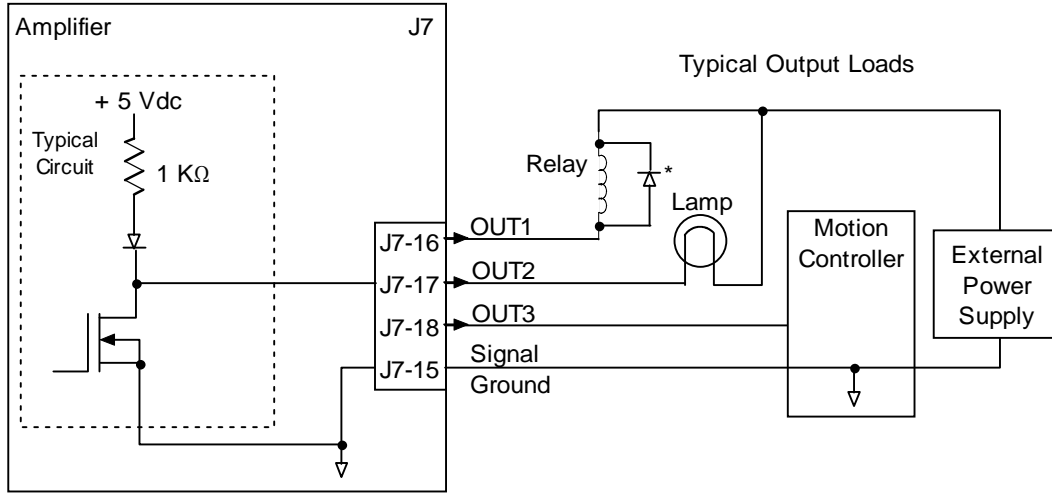

* Flyback diode required for inductive loads

Multi-Mode Port Interface Diagram

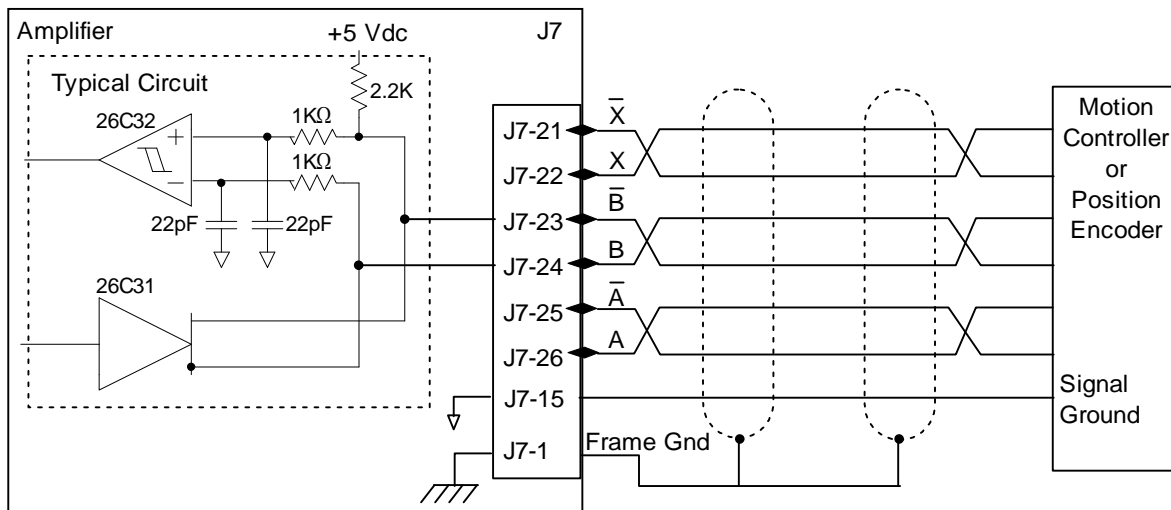

Analog Input Wiring Diagram

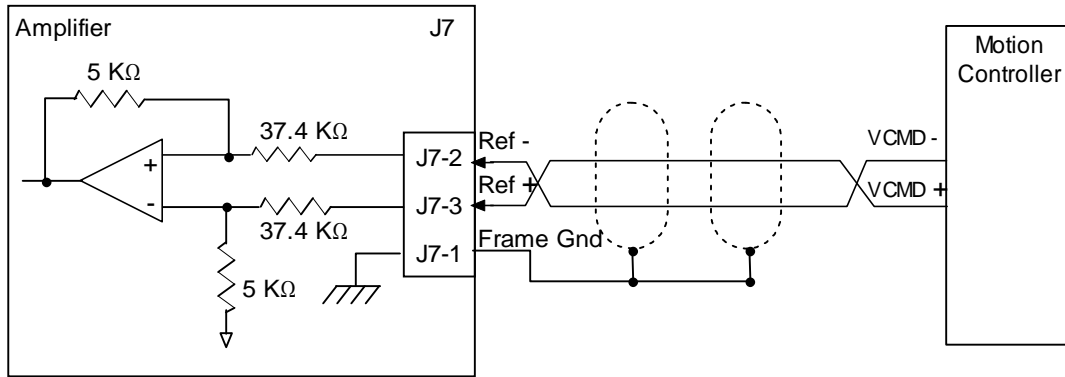

4.9: Motor Feedback (J8)

Mating Connector

Description	Manufacturer PN	Wire Size
15 Position, High-Density D-Sub Male Solder Style Connector	Norcomp 180-015-103L001	24 - 30 AWG
Back shell	Norcomp 939-009-020R121	
Solder style connector included in Connector Kit PN XTL-CK		

Pin connections are shown here:



J8 pin connections

J8 Pin Description Quad A/B Incremental Encoder Xenus

Pin	Signal	Function		
1	Frame Ground	Cable shield connection		
2	+5 Vdc	Encoder and/or Halls +5 Vdc power supply output. Total load current on J7-20, J8-2, and J8-4 not to exceed 400 mA.		
3	Digital Hall U			
4	+5 Vdc	Encoder and/or Halls +5 Vdc power supply output. Total load current on J7-20, J8-2, and J8-4 not to exceed 400 mA.		
5	Signal Ground	Signal and +5 Vdc ground		
6	Digital Hall V			
7	Encoder /X Input	Primary incremental encoder inputs		
8	Encoder X Input			
9	Digital Hall W			
10	[IN5] Motemp	Motor over temperature switch May be programmed to other functions	Standard speed	Pull-up/pull-down group 2
11	Encoder /B Input	Primary incremental encoder inputs		
12	Encoder B Input			
13	Encoder /A Input			
14	Encoder A Input			
15	Signal Ground	Signal and +5 Vdc ground		

J8 Pin Description Resolver Xenus (-R)

Pin	Signal	Function		
1	Frame Ground	Cable shield connection		
2	Ref(-) Output R2	Resolver excitation		
3	Ref(+) Output R1			
4	N.C.			
5	Signal Ground	Signal and +5 Vdc ground		
6	Frame Ground	Cable shield connection		
7	Sin(-) Input S1	Resolver inputs		
8	Sin(+) Input S3			
9	N.C.			
10	[IN5] Motemp	Motor over temperature switch May be programmed to other functions	Standard speed	Pull-up/pull-down group 2
11	Frame Ground	Cable shield connection		
12	Cos(-) Input S4	Resolver inputs		
13	Cos(+) Input S2			
14	N.C.			
15	Signal Ground	Signal and +5 Vdc ground		

J8 Pin Description Analog Sin/Cos Encoder Xenus (-S)

Pin	Signal	Function
1	Frame Ground	Cable shield connection
2	+5 Vdc	Encoder and/or Halls +5 Vdc power supply output. Total load current on J7-20, J8-2, and J8-4 not to exceed 400 mA.
3	Digital Hall U	
4	+5 Vdc	Encoder and/or Halls +5 Vdc power supply output. Total load current on J7-20, J8-2, and J8-4 not to exceed 400 mA.
5	Signal Ground	Signal and +5 Vdc ground
6	Digital Hall V	
7	Encoder /X Input	
8	Encoder X Input	
9	Digital Hall W	
10	[IN5] Motemp	Motor over temperature switch May be programmed to other functions
11	Encoder Cos(-)	Analog encoder inputs
12	Encoder Cos(+)	
13	Encoder Sin(-)	
14	Encoder Sin(+)	
15	Signal Ground	Signal and +5 Vdc ground

Quad A/B Incremental Encoder Wiring Diagram

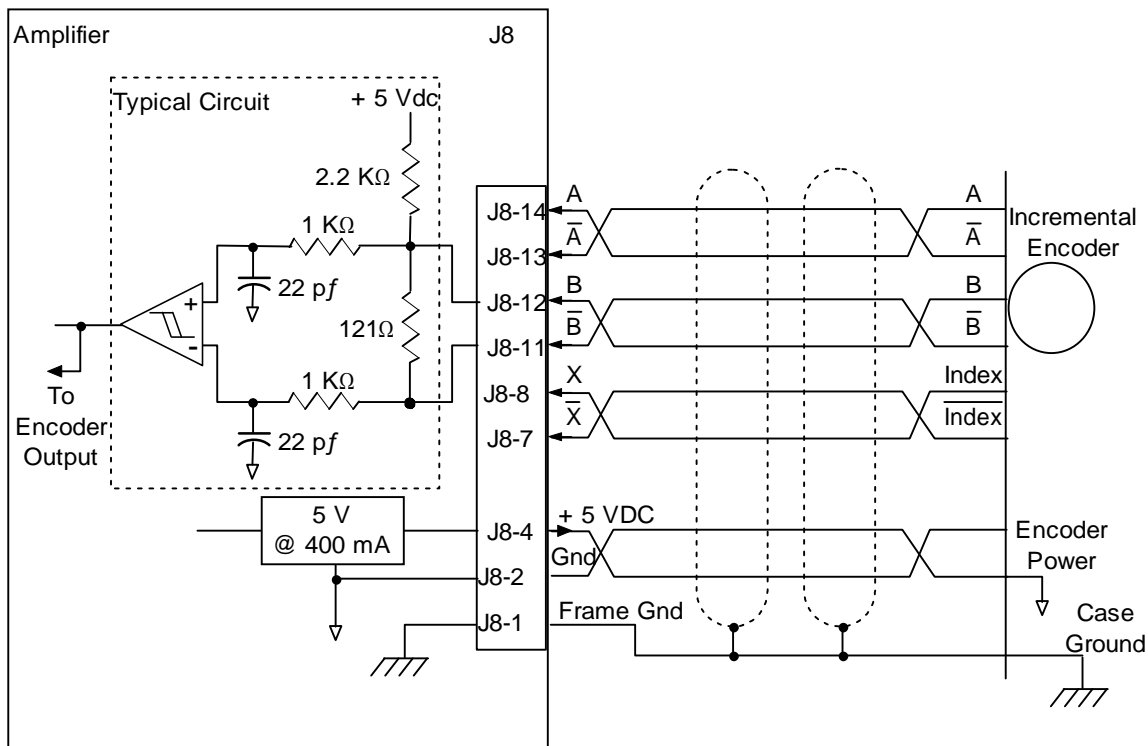

Hall Switch Wiring Diagram

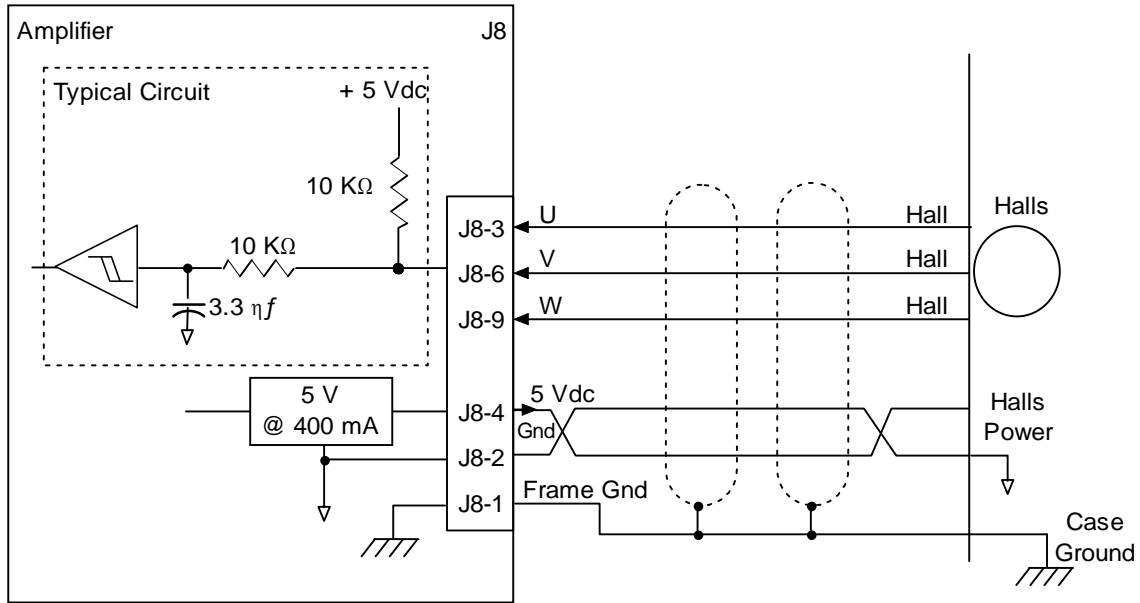

Analog Sin/Cos Encoder Wiring Diagram

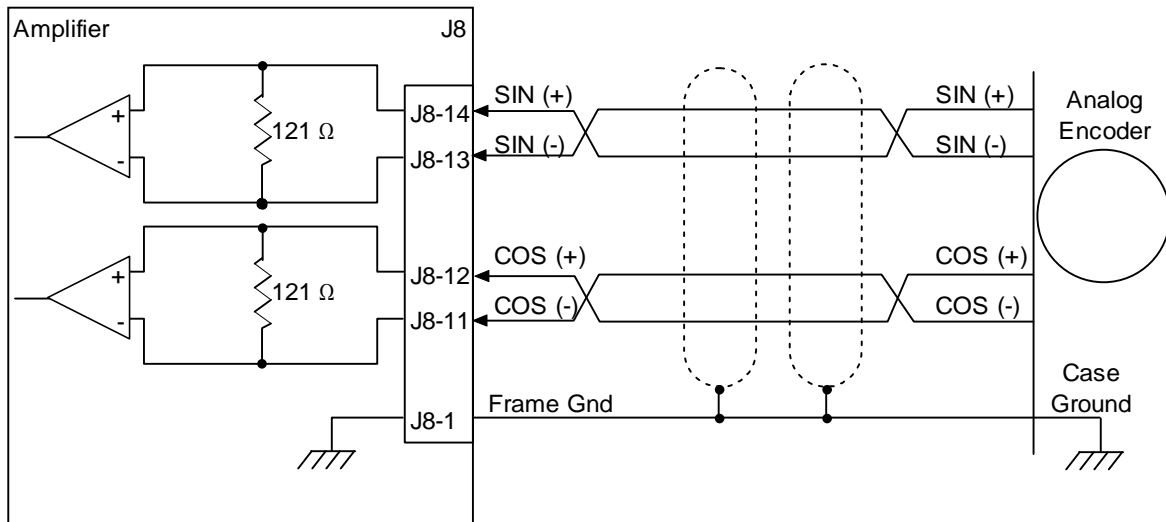

Resolver Wiring Diagram

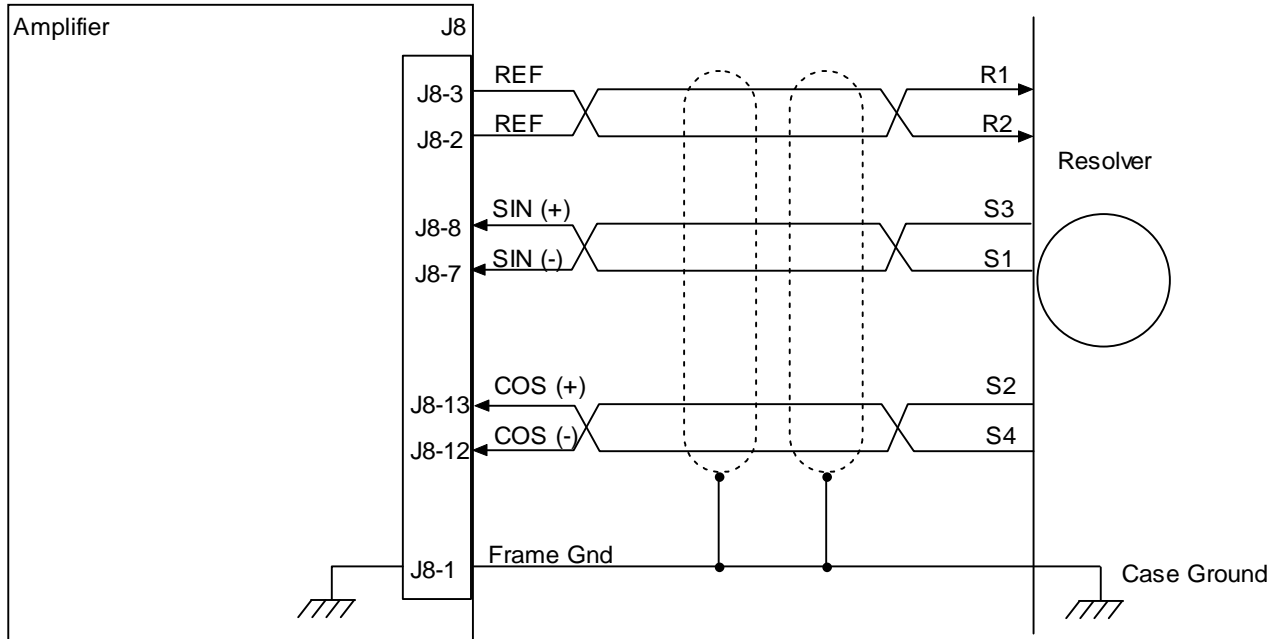

Motor Over Temperature Wiring Diagram

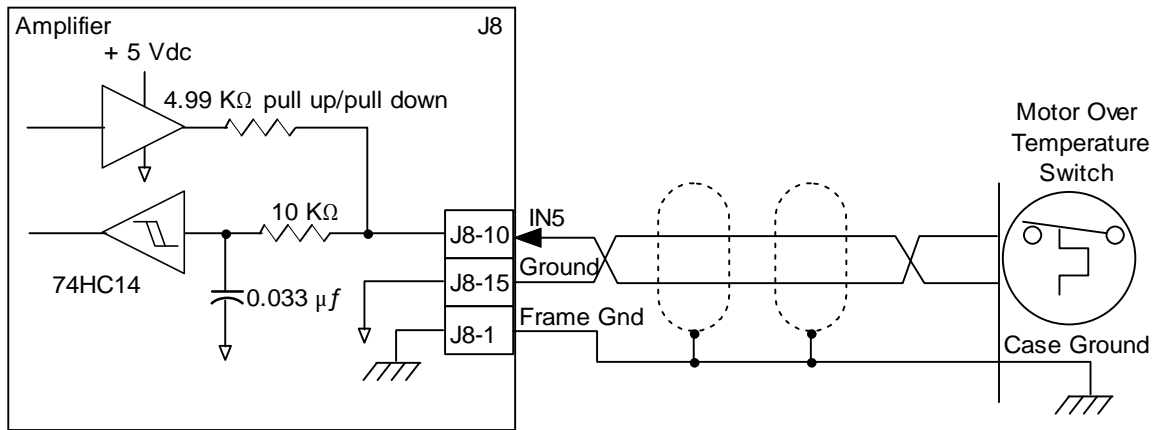

CHAPTER

5: QUICK SETUP WITH CME 2

This chapter describes the general procedure for configuring and tuning an amplifier with a motor.
(To copy setup data from an existing Copley Controls axis file (.ccx), skip to [Quick Copy Setup Procedure \(p. 135\)](#).)

Step	Page
5.1: Warnings	74
5.2: CME 2 Installation and Serial Port Setup	75
5.2.1: Requirements	75
5.2.2: Special Notes for Vista Users	75
5.2.3: Downloading Software from Web (Optional)	76
5.2.4: Installing CME 2 Software.....	76
5.2.5: Serial Port Setup.....	77
5.3: Prerequisites	79
5.3.1: Hardware and Equipment	79
5.3.2: Starting CME 2 and Choosing an Amplifier.....	80
5.4: Basic Setup	81
5.4.1: Basic Setup Screen	81
5.5: Motor/Feedback Setup	84
5.5.1: Load Motor/Feedback/Brake Settings from a File	84
5.5.2: Enter Motor/Feedback/Brake Settings Manually	85
5.5.3: Rotary Motor Setup Parameters	86
5.5.4: Linear Motor Setup Parameters	87
5.5.5: Feedback Parameters, Rotary	88
5.5.6: Feedback Parameters, Linear.....	89
5.5.7: Feedback Notes.....	90
5.5.8: Brake/Stop Parameters	91
5.5.9: The Calculate Function.....	92
5.6: Amplifier Configuration	93
5.6.1: Digital Inputs.....	93
5.6.2: Digital Input Functions	94
5.6.3: Standard Input Function Assignments	94
5.6.4: Standard Digital Outputs.....	95
5.6.5: Custom Digital Output Settings: Custom Event.....	96
5.6.6: Custom Digital Output Settings: Custom Trajectory Status.....	98
5.6.7: Custom Digital Output Settings: Position Triggered Output.....	99
5.6.8: Save Input/Output Changes.....	99
5.6.9: Non-Latched and Latched Custom Outputs	100
5.6.10: Fault Latching	101
5.6.11: Regen Resistor	102
5.7: Command Input	103
5.7.1: Analog Input	104
5.7.2: PWM Input.....	106
5.7.3: Digital Position Input.....	107
5.7.4: CAN Interface.....	109
5.8: Auto Phase.....	110
5.8.1: Auto Phase Warnings and Notes.....	110
5.8.2: Auto Phase Procedure.....	111
5.8.3: Guidelines for Choosing Auto Phase Current and Increment Rate Values.....	115
5.8.4: Trouble Shoot Motor Direction Setup.....	115
5.8.5: Trouble Shoot Motor Wiring Setup.....	115
5.8.6: Trouble Shoot Halls Wiring Setup.....	115
5.8.7: Trouble Shoot Other Problems	115
5.9: Current Loop.....	116
5.9.1: Current Loop Settings	116
5.9.2: Auto Tune the Current Loop.....	117
5.10: Velocity Loop.....	120
5.10.1: Velocity Loop Settings	120
5.10.2: Manually Tune the Velocity Loop	121
5.11: Position Loop.....	122
5.11.1: Position Loop Settings	122
5.11.2: Manually Tune the Position Loop.....	123
5.11.3: Test S-Curve Profile.....	125
5.12: Completion Steps	126

5.12.1: Objective 126
5.12.2: Steps 126

5.1: Warnings



DANGER: Hazardous voltages.

Exercise caution when installing and adjusting.

Failure to heed this warning can cause equipment damage, injury, or death.

DANGER



Make connections with power OFF.

Do not make connections to motor or drive with power applied.

Failure to heed this warning can cause equipment damage, injury, or death.

DANGER



Spinning motor with power off may damage amplifier.

Do not spin motors with power off. Voltages generated by a motor can damage an amplifier.

Failure to heed this warning can cause equipment damage.

WARNING

5.2: CME 2 Installation and Serial Port Setup

5.2.1: Requirements

Computer Requirements

Minimal hardware requirements:

- **CPU:** Minimum: 400 MHZ*
- **RAM:** Minimum: 128 MB*

*Using the minimum requirements will allow CME 2 to run, but performance will be significantly reduced.

Communication Requirements

For serial communications:

- At least one standard RS-232 serial port or a USB port with a USB to RS-232 adapter.
- At least one serial communication cable. Available from Copley Controls. Copley Controls cable part number: SER-CK.

For CAN communications:

- One Copley Controls CAN PCI network card (part number CAN-PCI-02).
CME 2 also supports CAN network cards made by these manufacturers: KVaser, Vector, and National Instruments.
- One PC-to-amplifier CANopen network cable.

Software Requirements

Copley Controls CME 2 software, Version 5.0 or higher.

Operating System Requirements

Operating Systems Supported: Windows NT, 2000, XP. Vista users see [Special Notes for Vista Users](#).

5.2.2: Special Notes for Vista Users

Copley Controls is actively working on support for Windows Vista. CME 2, version 5.0, operates under Windows Vista, with the following open issues:

- When the installer starts, Vista displays a message stating that an unidentified program is trying to access the computer. Click the button to allow the installer to continue, and CME 2 will be installed properly.
- When CME 2 is started up for the first time after installation, Vista displays a message stating that CME 2 may not have been installed properly. Click the button to indicate that CME 2 was installed properly. CME 2 will start and operate normally from this point on.
- The default file locations for CME 2's data files (ccx, ccm, etc.) are in the "Program Files/Copley Motion/CME 2" folder. Vista does not allow programs to write to the Program Files folder; instead, it re-directs the file writes to a separate users folder.
All of CME 2's data folders will be under this path:
C:\Users\user name\AppData\Local\VirtualStore\ProgramFiles\Copley Motion\CME 2
where "user name" is the account name displayed when logging in to Vista. Because the user account name is part of the path, it is recommended that CME 2 be run under the same user account until CME 2 fully supports Vista. If a user without administrative privileges logs in and runs CME 2, that user will not be able to access any files created by CME 2 under a different user account.

5.2.3: Downloading Software from Web (Optional)

- 5.2.3.1 Choose or create a folder where you will download the software installation file.
- 5.2.3.2 In an internet browser, navigate to <http://www.copleycontrols.com/Motion/Downloads/index.html>.
- 5.2.3.3 Under *Software Releases*, click on *CME 2*.
- 5.2.3.4 When prompted, save the *CME2.zip* file to the folder chosen or created in Step 5.2.3.1.
The folder should now contain a file named *CME2.zip*.
- 5.2.3.5 Extract the contents of the zip file to the same location.
The folder should now contain the files *CME2.zip* and *Setup.exe*.
- 5.2.3.6 If desired, delete *CME2.zip* to save disk space.

5.2.4: Installing CME 2 Software

- 5.2.4.1 If installing from a CD, insert the CD (Copley Controls part number *CME2*).
Normally, inserting the CD causes the installation script to launch, and a CME 2 Installation screen appears. If so, skip to Step 5.2.4.3.
- 5.2.4.2 If the software installation file was downloaded from the Copley Controls website, navigate to the folder chosen or created in Step 5.2.3.1, and then double-click on *Setup.exe*
OR
if you inserted the CD and the CME 2 *Installation* screen did not appear, navigate to the root directory of the installation CD and then double-click on *Setup.exe*.
- 5.2.4.3 Respond to the prompts on the CME 2 *Installation* screens to complete the installation. We recommend accepting all default installation values.

5.2.5: Serial Port Setup

One or more serial ports on a PC can be used to connect amplifiers. Use the following instructions to add (enable) ports for amplifiers, to choose baud rates for those ports, and to remove (disable) ports for amplifiers.

- 5.2.5.1 Start CME 2 by double-clicking the CME 2 shortcut icon on the Windows desktop:



If a serial or CAN port has not been selected, the *Communications Wizard Select device* screen appears.



- 5.2.5.2 If the CME 2 *Main* screen appears instead of *Select device*, choose **Tools**→**Communications Wizard**.

- 5.2.5.3 Choose **Serial Ports** and click **Next** to open the *Communications Wizard Select Ports* screen.

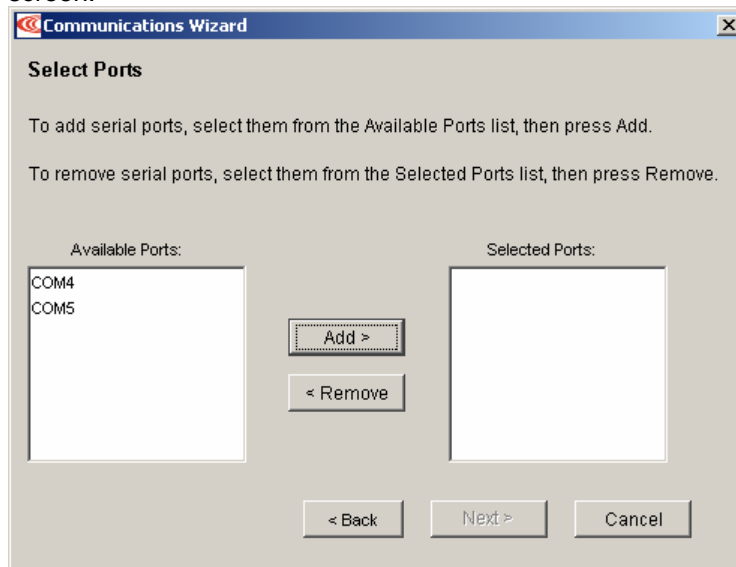

- 5.2.5.4 From the *Available Ports* list on the *Select Ports* screen, choose the serial ports that will be used to connect to amplifiers.

- 1 To allow connection of an amplifier through a port, highlight the port name and click **Add** (or click **Add All** to enable all available ports).
- 2 To remove a port from the *Selected Ports* list, highlight the port name and click **Remove**.

- 5.2.5.5 Click **Next** to save the choices and open the *Communications Wizard Configure Serial Ports* screen.

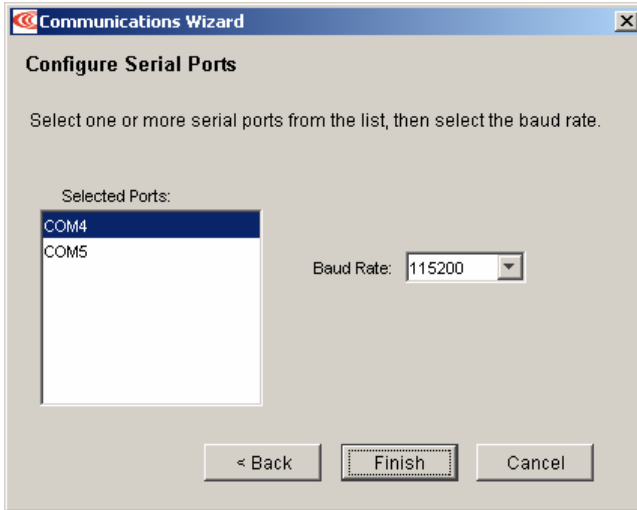

- 5.2.5.6 Configure the selected ports.
- 1 Highlight a port in the *Selected Ports* list.
 - 2 Choose a *Baud Rate* for that port.
 - 3 Repeat for each selected port.
- 5.2.5.7 Click **Finish** to save the choices.

5.3: Prerequisites

5.3.1: Hardware and Equipment

- 5.3.1.1 Verify that +24 Vdc power is OFF and AC power is OFF.
- 5.3.1.2 Verify wiring and connections.
Ensure the following connections are wired according to the guidelines in [Wiring \(p. 53\)](#).
- 1 J8 "FDBCK" motor signals
 - 2 J2 "U V W Earth" motor power
 - 3 J7 "CNTRL" control signals
 - 4 J4 "+24 Vdc, BRAKE" required +24 Vdc (power OFF)
 - 5 J5 "RS-232" PC serial link
 - 6 J1 "L1 L2 L3 Earth" line power (power OFF)
- 5.3.1.3 Secure the motor:
- 1 Make sure motor is securely fastened.
 - 2 Make sure that no load is connected to the motor.
- 5.3.1.4 Apply +24 Vdc to the amplifier's J4 connection.
(Do NOT apply AC voltage to the amplifier at this point.)



DANGER

Risk of unexpected or uncontrolled motion with CME 2 in CAN or DeviceNet mode.

CME 2 can be used while the amplifier is under CAN or DeviceNet control. However, some extreme changes made with CME 2 could cause unexpected or uncontrolled motion.

Failure to heed this warning can cause equipment damage, injury, or death.

5.3.2: Starting CME 2 and Choosing an Amplifier

NOTE: Digital input 1 (IN1) should be configured as a hardware disable. It may then be used to immediately disable the amplifier. To software disable the amplifier at any time while running CME 2, press function key **F12**.

5.3.2.1 Verify CME 2 installation and serial port configuration.

5.3.2.2 Start CME 2 by double-clicking the CME 2 shortcut icon on the Windows desktop:  If there are multiple ports, the Copley Neighborhood root will be selected:

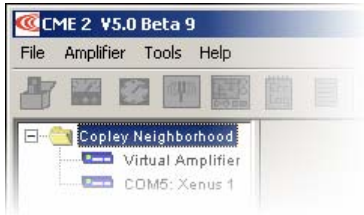

5.3.2.3 Select the desired amplifier. For instance:



After an amplifier has been selected, the CME 2 Main Screen looks similar to this:

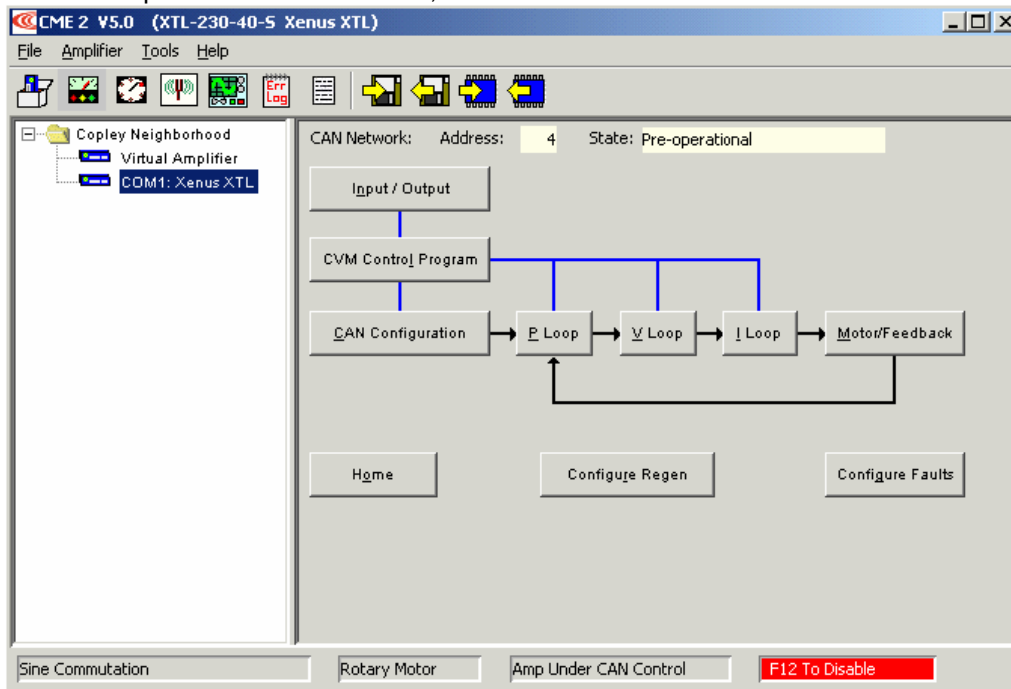

If the Basic Setup options have not been chosen, the *Basic Setup* screen opens.

5.4: Basic Setup

5.4.1: Basic Setup Screen

- 5.4.1.1 To configure an amplifier for use with a Copley Controls ServoTube motor, see the *CME 2 User's Guide*.
- 5.4.1.2 To load a .ccx file that was prepared for the amplifier/motor combination, see [Quick Copy Setup Procedure \(p. 135\)](#).
- 5.4.1.3 Click the **Basic Setup** button () to display the *Basic Setup* screen.

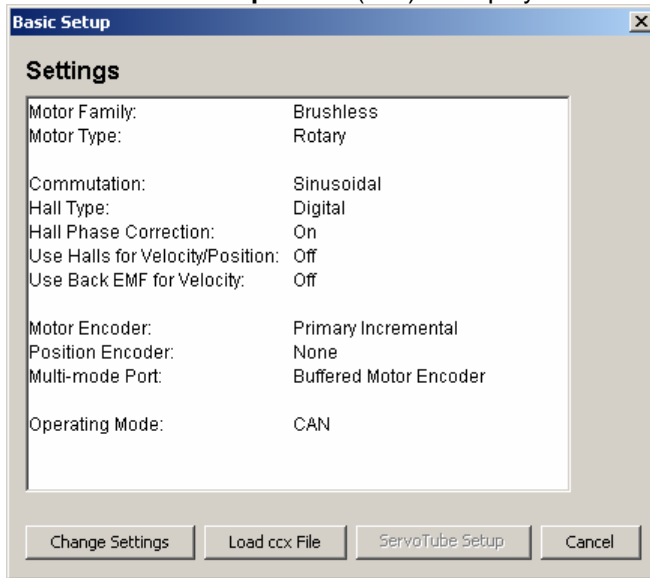

- 5.4.1.4 Click **Change Settings** to start the Basic Setup wizard. Use the Back and Next buttons to navigate screens. Screen details vary depending on amplifier model and mode selection.
- 5.4.1.5 View or change the Motor settings described below. Options vary with amplifier model.

Setting	Description
Motor Family	Select motor family: Brushless or Brush.
Motor Type	Select motor type: Rotary or Linear.

5.4.1.6 View or change the Feedback settings described below. Options vary with amplifier model.

Setting	Description
Hall Type	Select Hall type: None, Digital, or Analog (Analog is used with Copley Controls ServoTube motors).
Hall Phase Correction	If selected, will enable error checking between Hall switches and encoder based phase angle.
Motor Encoder	Select type and source of motor feedback. <ul style="list-style-type: none"> • None: No motor encoder. • Primary Incremental: Incremental encoder on primary feedback connector. • Secondary Incremental: Incremental encoder on multi-mode port. • Analog: Analog encoder on primary feedback connector. • Low Frequency Analog: Copley ServoTube motor on primary feedback connector. • Resolver (Resolver version only): Resolver on primary feedback connector.
Position Encoder	Select type and source of Position (load) feedback. <ul style="list-style-type: none"> • None: No position encoder. • Primary Incremental: Incremental encoder on primary feedback connector. • Secondary Incremental: Incremental encoder on multi-mode port. • Analog: Analog encoder on primary feedback connector.
Position Encoder Type	Select the type of Position (load) encoder: <ul style="list-style-type: none"> • Rotary. • Linear.
Use Position Encoder in Passive (Monitor) Mode	When this is checked, the position of the position encoder will be reported by the passive load position variable but it will not be used to control the position of the axis.

5.4.1.7 View or change the Operating Mode settings described below. Options vary with amplifier model.

Setting	Description
Operating Mode	Choose the mode of operation: Current, Velocity, or Position.
Command Source	Choose the command input source: <ul style="list-style-type: none"> • Analog Command: Analog voltage provides command input. See Analog Input (p. 104). • PWM command (current and velocity mode only): Digital pulse-width modulated signal provides command input. See PWM Input (p. 106). • Function Generator: Internal function generator provides command input. • Software Programmed: The amplifier is controlled by software commands from either the Copley Virtual Machine (CVM) or an external source. See <i>Copley Indexer Program User's Guide</i> or the <i>Copley ASCII Interface Programmer's Guide</i>. • Camming: Amplifier runs in Camming Mode. See <i>Copley Camming User Guide</i>. • Digital Input: Command input is provided via the Input Source selected from the choices described below. See Digital Position Input (p. 107). • CAN: Command input is provided over the CANopen network. See the <i>CANopen Programmer's Guide</i>.
Input Source	Choose the input source for PWM or Digital input commands: <ul style="list-style-type: none"> • Single-ended Inputs: Command input is provided via two of the amplifier's programmable digital inputs. • Multi-mode Port: Command input is provided via differential inputs on the amplifier's multi-mode port. • Differential Inputs: Command is provided via the amplifier's differential inputs.

5.4.1.8 View or change the Miscellaneous settings described below. Options vary with amplifier model.

Setting	Description
Commutation	Select commutation method: Sinusoidal or Trapezoidal.
Use back EMF for Velocity	If selected, will use the motor’s measured back EMF to determine motor velocity. Recommended only for medium- to high-speed. Accuracy depends on the accuracy of the programmed Back EMF value, and may be affected by factors such as cable resistance.
Use Halls for Velocity and Position	If selected, will use transitions of the Hall switches to determine motor velocity and position. Recommended only for medium- to high-speed applications (may run roughly at low speeds).
Multi-mode Port	Selects the mode for the amplifier’s multi-mode port: <ul style="list-style-type: none"> • Buffered Motor Encoder. The multi-mode port functions as a buffered digital encoder output based on the digital encoder input. • Emulated Motor Encoder. The multi-mode port functions as an emulated digital encoder output based on the motor analog encoder or motor resolver. • Emulated Position Encoder. The multi-mode port functions as an emulated digital encoder output based on the position analog encoder. • Differential Input. The multi-mode port functions as a differential command input.

5.4.1.9 Click **Finish** to close the **Basic Setup** screen.

5.5: Motor/Feedback Setup

Motor, Feedback, and Brake settings can be loaded from a file or entered manually into the fields. Choose the appropriate method and perform the steps described:



- Load Motor/Feedback/Brake Settings from a File (p. 84)
- Enter Motor/Feedback/Brake Settings Manually (p. 85)

5.5.1: Load Motor/Feedback/Brake Settings from a File

5.5.1.1 To download motor data files from the website:

- 1 In an internet browser, navigate to <http://www.copleycontrols.com/Motion/Downloads/motorData.html>
- 2 Click on the appropriate motor name.
- 3 When prompted, save the file to the *MotorData* folder in the CME 2 installation folder.
- 4 (The default installation folder is C:\Program Files\Copley Motion\CME 2\MotorData.)
- 5 Extract the contents of the zip file to the same location.
- 6 The folder should now contain the new motor data file (with a *.ccm* filename extension).
- 7 If desired, delete the *.zip* file to save disk space.

5.5.1.2 To load motor data from a motor data file

- 1  Click **Motor/Feedback** to open the *Motor/Feedback* screen.
- 2 On the *Motor/Feedback* screen, click **Restore Motor Data from Disk** (). When prompted, navigate to the folder containing the file, then click on the file name, and then click **Open**.
- 3 Proceed to [The Calculate Function \(p. 92\)](#).

5.5.2: Enter Motor/Feedback/Brake Settings Manually

5.5.2.1

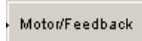

Click **Motor/Feedback** to open the *Motor/Feedback* screen.

A Motor/Feedback screen representing a typical rotary motor is shown below. Parameters vary with amplifier model.

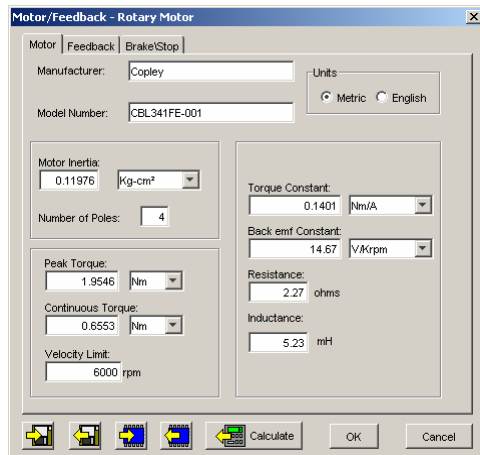

5.5.2.2

Click the **Motor** tab to view or change [Rotary Motor Setup Parameters \(p. 86\)](#) or [Linear Motor Setup Parameters \(p. 87\)](#).

5.5.2.3

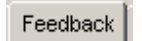

Click the **Feedback** tab to view or change [Feedback Parameters, Rotary \(p. 88\)](#) or [Feedback Parameters, Linear \(p. 89\)](#). Read the [Feedback Notes \(p. 90\)](#) for important related information.

5.5.2.4

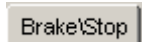

Click the **Brake/Stop** tab to view or change [Brake/Stop Parameters \(p. 91\)](#). Read the [Brake/Stop Notes \(p. 91\)](#) for important related information.

5.5.2.5

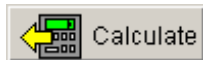

Use [The Calculate Function \(p. 92\)](#) to calculate initial gains and limits.

5.5.2.6



On the Main screen, click **Save to Flash** to avoid losing the changes.

5.5.2.7

View or change the settings described below. Options vary with amplifier model. Metric units are shown here.

5.5.3: Rotary Motor Setup Parameters

View or change the settings described below. Options vary with amplifier model. Metric units are shown here.

Setting	Description
Manufacturer	Motor manufacturer's name. Saved for reference in the motor data file.
Model Number	Motor model number. Saved for reference in the motor data file.
Units	Selects whether the parameters entered in this screen are in Metric or English units.
Motor Inertia	The rotor inertia of the motor. Used for calculating initial velocity loop tuning values. Range: 0.00001 to 4,294 kg cm ² . Default: 0.00001 kg-cm ² .
Number of Poles	(Brushless only.) The number of magnetic poles in the motor. Required for correct commutation of the motor. Range: 2 to 200. Default: 4.
Peak Torque	The peak torque that the motor can produce. Peak Torque divided by torque constant = motor's peak current limit. Range: 0.001 to 2,100 Nm. Default: 0.0001 Nm.
Continuous Torque	The continuous torque that the motor can produce. Used with the torque constant to calculate continuous current. Range: 0.001 to 1,000 Nm. Default: 0.0001 Nm.
Velocity Limit	Maximum speed of the motor. Used to calculate the velocity and acceleration limits for the velocity loop. Range dependent on encoder resolution.
Torque Constant	Relates the motor's input current to torque produced. Sometimes abbreviated as Kt. Range: 0.001 to 1,000 Nm/Apk. Default: 0.001 Nm/Apk.
Back emf Constant	Relates the motor's input voltage to speed. Sometimes abbreviated as Ke. Used for calculating the maximum velocity for a given amplifier bus voltage. Range: 0.01 to 21,000,000 V/Krpm. Default: 0.01 V/Krpm.
Resistance	Motor resistance line-to-line. Used for calculating the initial current loop tuning values. Range: 0.01 to 327 Ω. Default: 0.01 Ω.
Inductance	Motor inductance line-to-line. Used for calculating the initial current loop tuning values. Range: see Power Output (p. 44) .

5.5.4: Linear Motor Setup Parameters

View or change the settings described below. Options vary with amplifier model. Metric units are shown here.

Setting	Description
Manufacturer	Motor maker's name. Saved in the motor data file. Choose from list or enter manually.
Model Number	Motor model number. Saved in the motor data file. Choose from list or enter manually.
Units	Selects whether the parameters entered in this screen are in Metric or English units.
Mass	The mass of the motor. Used for calculating initial velocity loop tuning values. Range: .0001 Kg to 100,000 Kg. Default: .0001 Kg.
Peak Force	The peak force that the motor can produce. Peak Force divided by Force Constant = motor's peak current limit. Range: 0.00001 to 2,000 N. Default: 0.00001 N.
Continuous Force	The continuous force that the motor can produce. Used with the force constant to calculate continuous current. Range: 0.00001 to 1,000 N. Default: 0.00001 N.
Velocity Limit	Maximum speed of the motor. Used to calculate the velocity and acceleration limits for the velocity loop. Range dependent on encoder resolution.
Force Constant	Relates the motor's input current to force produced. Sometimes abbreviated as Kf. Range: 0.00001 to 2,000 N/Amp. Default: 0.00001 N/Amp.
Back emf Constant	Relates the motor's input voltage to speed. Sometimes abbreviated as Ke. Used for calculating maximum velocity for a given amplifier voltage. Range: 0.01 to 1,000 V/M/Sec. Default: 0.01 V/M/Sec.
Resistance	Motor resistance line to line. Used for calculating the initial current loop tuning values. Range: 0.01 to 327 Ω . Default: 0.01 Ω .
Inductance	Motor inductance line to line. Used for calculating the initial current loop tuning values. Range: see Power Output (p. 44) .
Magnetic Pole Pair Length	The length of a pair of magnets which equals the distance moved in one electrical cycle of the motor.

5.5.5: Feedback Parameters, Rotary

As appropriate for each encoder or resolver, enter the options described here.

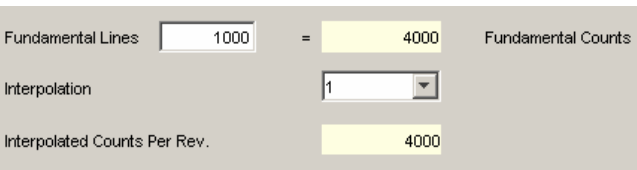
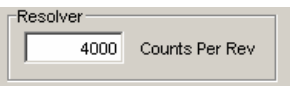
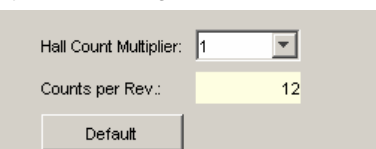
Feedback Type	Parameters/Actions
Incremental	<p>In the <i>Motor Encoder</i> lines or <i>Position Encoder</i> lines field, enter the number of encoder lines (see encoder or motor data sheet). As indicated by the counts field, the number of encoder counts per revolution is equal to 4 x the number of lines.</p> 
Analog	<p>In Fundamental Lines, enter the number of fundamental encoder lines (see encoder or motor data sheet). As indicated by the <i>Fundamental Counts</i> field, the number of fundamental encoder counts per revolution is equal to 4 x the number of Fundamental Lines.</p> <p>Optionally modify the encoder resolution by changing the Interpolation value. The interpolated resolution (Interpolated Counts Per Rev) is the product of Fundamental Counts value and the Interpolation value.</p> 
Resolver	<p>Optionally modify the feedback resolution by changing the value in Counts Per Rev. Default: 16384.</p> 
Halls	<p>With amplifier set to Use Halls for Velocity/Position, optionally increase the counts per rev ratio by incrementing the Halls Count Multiplier.</p> 

If two feedback devices are installed, verify that the values of Motor Turns to Position Turns correctly represent the ratio of motor encoder turns to position encoder turns.

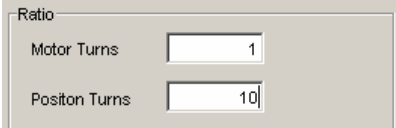

5.5.6: Feedback Parameters, Linear

As appropriate for each encoder installed, enter the options described below.

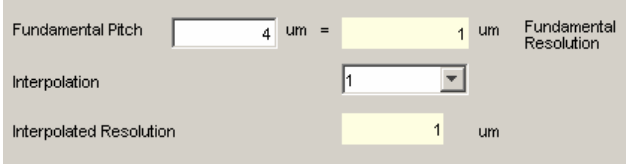
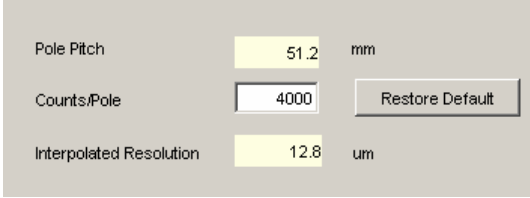
Feedback Type	Parameters/Actions
Incremental	<p>Choose units and then enter the Encoder Resolution (see encoder or motor data sheet).</p> 
Analog	<p>Enter the Fundamental Pitch (distance between encoder lines; see encoder or motor data sheet). As indicated by the <i>Fundamental Resolution</i> field, Fundamental Pitch divided by four gives Fundamental Resolution. The interpolated resolution is the dividend of Fundamental Resolution value/Interpolation value. Optionally modify the Interpolated Resolution by changing the Interpolation value.</p> 
Low Frequency Analog	<p>(Normally used with ServoTube) Pole Pitch is the distance between poles in a pole pair, as entered in the <i>Magnetic Pole Pair Length</i> field on the Motor tab. The interpolated resolution is the dividend of Pole Pitch/Counts per pole value, expressed in micrometers. Optionally modify the resolution by changing the Counts/Pole value. Click Restore Default to restore default Counts/Pole.</p> 

5.5.7: Feedback Notes

Encoder and Resolver Support

The Xenus XTL is offered in three versions to support quad A/B encoder, analog sin/cos encoder, or resolver feedback. The encoder versions normally require Hall switches for the commutation of brushless motors. The resolver versions support standard, single speed, transmit-type resolvers.

Dual Feedback

The Xenus XTL can receive position feedback from sensors on the motor, the load, or both, through the primary feedback channel, a multi-mode encoder port, or both. (The amplifier can also operate in certain modes without encoders or resolvers.)

The multi-mode port can:

- Provide a buffered digital encoder output based on the digital encoder input.
- Provide an emulated digital encoder output based on the analog encoder or resolver input.
- Provide a second digital encoder input to be used in the dual encoder position mode. In this mode, an encoder attached to the load provides position loop feedback, and the motor encoder or resolver provides velocity loop feedback.

A dual-feedback setup is shown below. The amplifier receives feedback from an incremental motor encoder through the primary feedback channel. Position (load) encoder feedback comes through the multi-mode port. The ratio of motor turns to position encoder turns is 1 to 10.

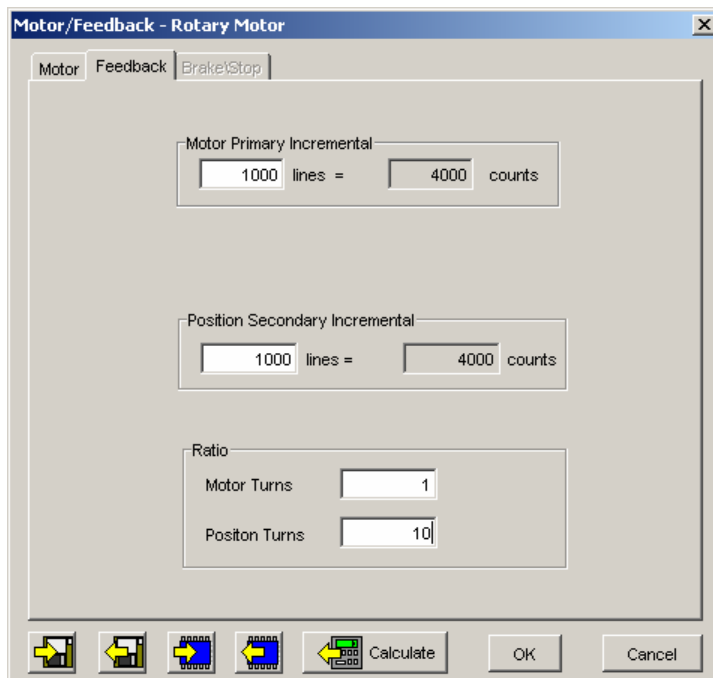

5.5.8: Brake/Stop Parameters

Enter the following parameters as appropriate.

Parameter	Description
Brake/Stop Delay Time	Range of accepted values: 0 to 10,000 mSec.
Brake Activation Velocity	Range of accepted values: motor-dependent.
PWM Delay Brake/Stop Response Time	Range of accepted values: 0 to 10,000 mSec.

Brake/Stop Notes

Many control systems employ a brake to hold the axis when the amplifier is disabled. On brake-equipped systems, disabling the amplifier by a hardware or software command starts the following sequence of events.

- The motor begins to decelerate (at Abort Deceleration rate in position mode or Fast Stop Ramp rate in velocity mode). At the same time, the Brake/Stop Delay Time count begins. This allows the amplifier to slow the motor before applying the brake.
- When the motor slows to Brake/Stop Activation Velocity OR the Brake/Stop Delay Time expires, the brake output activates and PWM Delay Brake/Stop Response Time count begins.
- When response time has passed, the amplifier's output stages are disabled. This delay ensures the brake has time to lock in before disabling the power section.

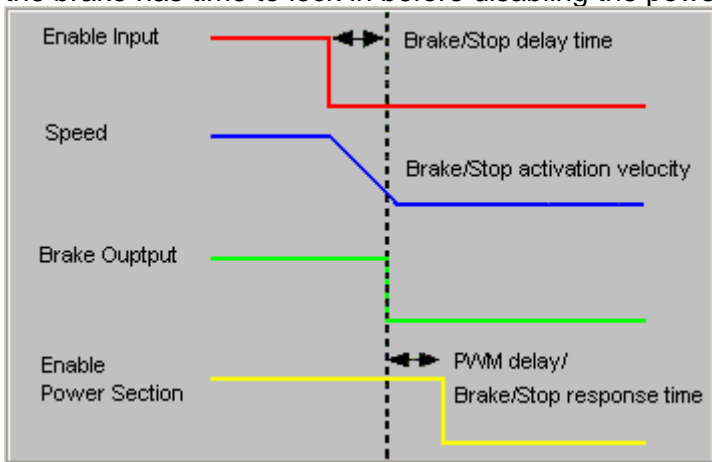

This sequence is not available in the current mode of operation. Instead, in current mode, the amplifier output turns off and the brake output activates immediately when the disable command is received.

5.5.9: The Calculate Function

The *Calculate* function uses the motor and encoder values entered to calculate initial loop gains and limits. These can be modified later to fine-tune the amplifier.

- 5.5.9.1  Click **Calculate** to calculate and display the settings.

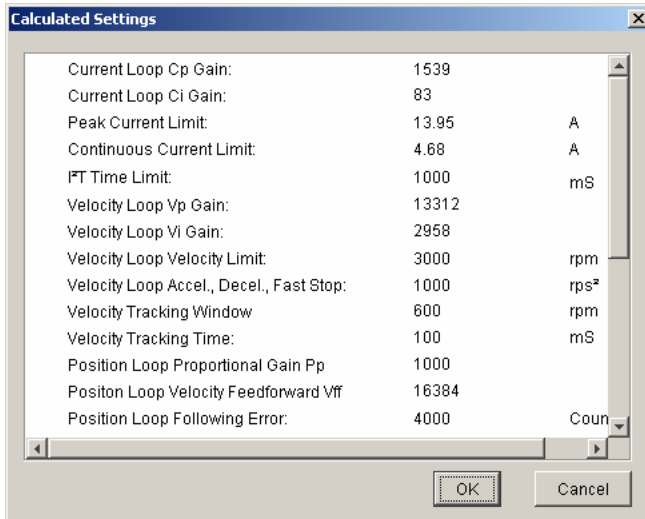

Verify the peak current limit, continuous current limit, and velocity loop velocity limit. If one or more of these values seems inappropriate, click **Cancel** and check: Peak Torque (or Force), Continuous Torque (or Force), Velocity Limit, and Torque (or Force) Constant. Correct them if needed. See [Rotary Motor Setup Parameters \(p. 86\)](#) or [Linear Motor Setup Parameters \(p. 87\)](#).

If the Motor/Feedback values were correct but the peak current limit, continuous current limit, or velocity loop velocity limit values are not optimal for the application, change these limits during the tuning process.

- 5.5.9.2 Load the values into volatile memory by clicking **OK**.

NOTE: If the motor wiring configuration in the motor file does not match the configuration currently stored in the amplifier, CME prompts for verification on which configuration to use. Select the file configuration by clicking **Yes**. The configuration will be tested later, in [Auto Phase \(p. 110\)](#).

- 5.5.9.3  On the Main screen, click **Save to Flash** to avoid losing the changes.

5.6: Amplifier Configuration

5.6.1: Digital Inputs

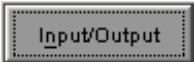

5.6.1.1 Click **Input/Output** to open the *Input/Output* screen.

A typical Input/Output screen is shown below. (Features vary with amplifier model and configuration.)

Red: inhibited motion or active input, depending on input function. Grey: motion not inhibited. None: not configured.

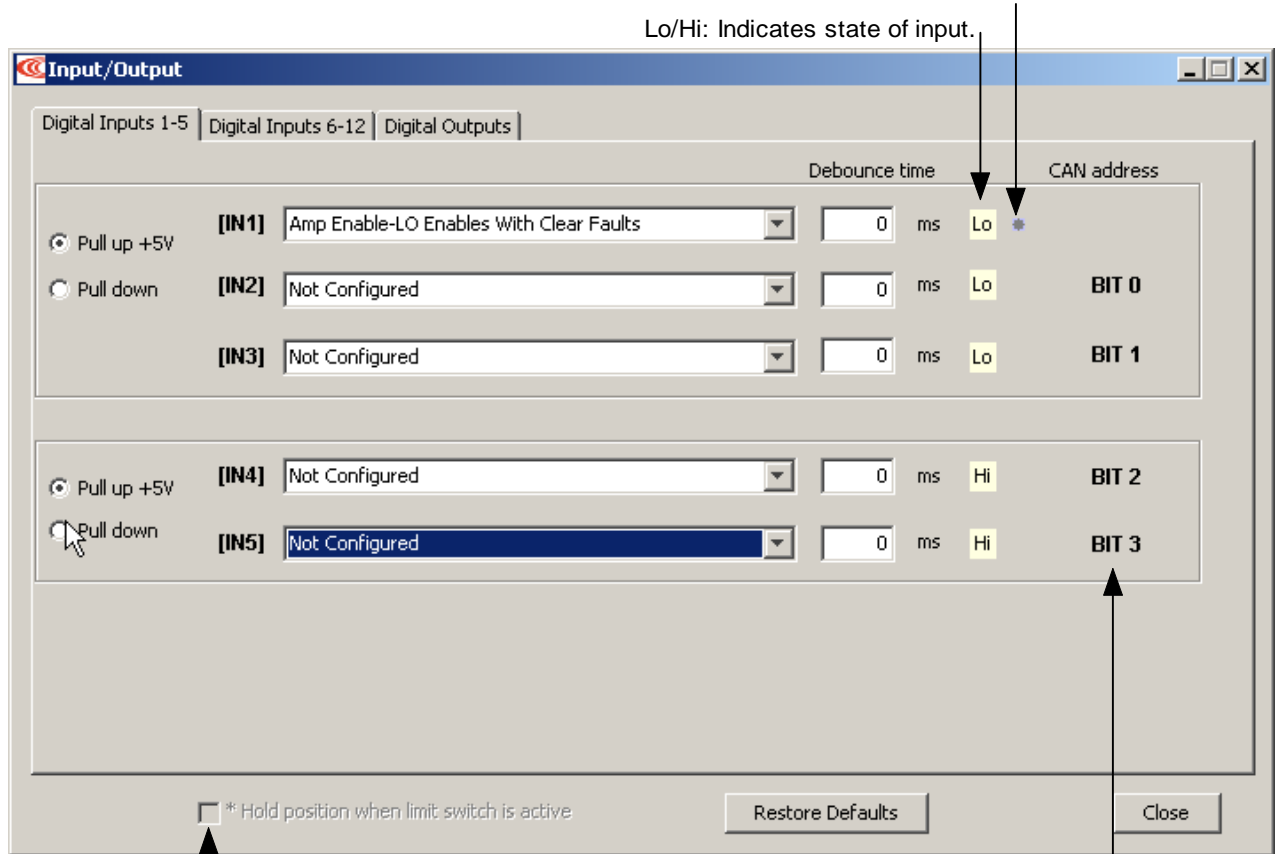

Hold position setting

Indicates input is used as a CAN address bit.

5.6.1.2 Enter the following options:

Parameter	Description
Pull up +5 V	Pulls up the group of inputs up to internal +5 V.
Pull down	Pulls the group of inputs down to internal signal ground.
Debounce Time	Sets the input debounce time (how long an input must remain stable at a new state before the amplifier recognizes the state). Increase to prevent undesired multiple triggering caused by switch bounce. Debounce time is ignored for digital command inputs such as PWM. Range: 0 to 10,000 mSec. See Debounce Time (p. 40) .
IN1-IN12	Select the function for the input. See Digital Input Functions (p 94) .
*Hold position when limit switch is active	Available in position mode when one or more inputs are configured as a limit switch (NEG Limit-HI Inhibits, NEG Limit-LO Inhibits, POS Limit-HI Inhibits, or POS Limit-LO Inhibits). The *Hold position option prevents any motion while a limit switch is active. CAUTION: If the amplifier is switched back to current or velocity mode with this option selected, the limit switches will no longer function.

The **Restore Defaults** button restores all inputs and outputs to factory defaults. The **Close** button closes the screen.

5.6.2: Digital Input Functions

The digital input functions are described below.

Input Function	Description
AMP Enable-LO Enables with clear faults	A low input will enable the amplifier. A low to high transition will clear latched faults and outputs.
AMP Enable-HI Enables with clear faults	A high input will enable the amplifier. A high to low transition will clear latched faults and outputs.
AMP Enable-LO Enables with reset	A low input will enable the amplifier. A low to high transition will reset the amplifier.
AMP Enable-HI Enables with reset	A high input will enable the amplifier. A high to low transition will reset the amplifier.
AMP Enable-LO Enables	A low input will enable the amplifier.
AMP Enable-HI Enables	A high input will enable the amplifier.
Not Configured	No function assigned to the input.
NEG Limit-HI Inhibits*	A high input will inhibit motion in negative direction.
NEG Limit-LO Inhibits*	A low input will inhibit motion in negative direction.
POS Limit-HI Inhibits*	A high input will inhibit motion in positive direction.
POS Limit-LO Inhibits*	A low input will inhibit motion in positive direction.
Reset on LO-HI Transition	A low to high transition of the input will reset the amplifier.
Reset on HI-LO Transition	A high to low transition of the input will reset the amplifier.
Motor Temp HI Disables	A high input will generate a Motor Over Temperature fault.
Motor Temp LO Disables	A low input will generate a Motor Over Temperature fault.
Home Switch Active HI	A high input indicates the home switch is activated.
Home Switch Active LO	A low input indicates the home switch is activated.
Motion Abort Active HI	A high input will stop motion, leaving amplifier enabled.
Motion Abort Active LO	A low input will stop motion, leaving amplifier enabled.
Hi Res Analog Divide Active HI	A high input causes the firmware to divide the level of the analog input signal by 8.
Hi Res Analog Divide Active LO	A low input causes the firmware to divide the level of the analog input signal by 8.
PWM Sync Input	PWM synchronization input. See Synchronizing PWM Switching Frequency (p. 16) . (For high-speed inputs only.)

5.6.3: Standard Input Function Assignments

Enable Input: On the XTL amplifier, IN1 is dedicated to the enable function.

Other inputs can be programmed as additional enables. If there is more than one input programmed as an enable then all the inputs must be in the enabled state before the amplifier PWM output stage will be enabled.

Motor Over Temperature: On the XTL amplifier, IN5 is located on the motor feedback connector and is intended to be used for Motor Over Temperature. **Other:** Other inputs may have predefined functions depending on mode of operation.

5.6.4: Standard Digital Outputs

5.6.4.1 Click the *Digital Outputs* tab of the *Input/Output* screen. A typical *Digital Outputs* screen is shown below. (Features may vary with amplifier model and configuration.)

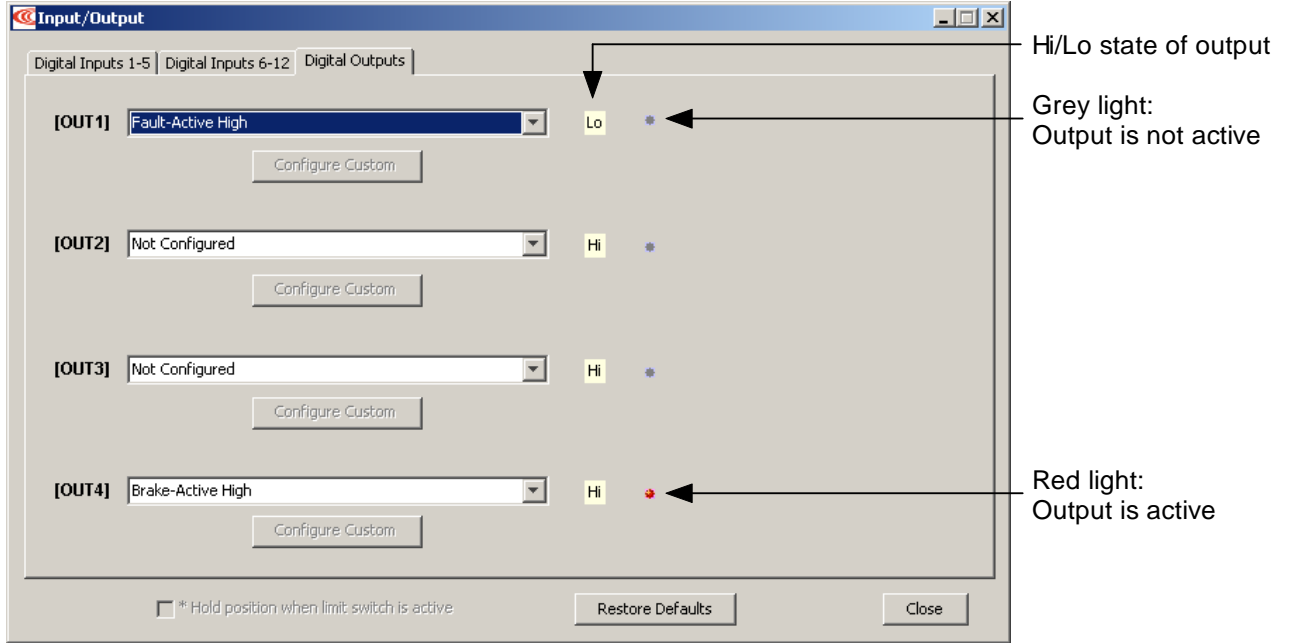

5.6.4.2 Choose any of the following functions for any output. OUT4 is recommended for brake function.

Output Function	Description	For More Information
Not Configured	No function assigned. Output remains high.	
Fault Active High	Output goes high when at least one fault is detected.	Faults (p. 34).
Fault-Active Low	Output goes low when at least one fault is detected.	
Brake-Active High	Output goes high to activate the brake.	Brake Operation (p. 31).
Brake-Active Low	Output goes low to activate the brake.	
PWM Sync Output (OUT1 only)	The PWM synchronization output.	Synchronizing PWM Switching Frequency (p. 16) and Digital Input Functions (p. 94).
Custom Event	See Custom Digital Output Settings: Custom Event (p. 96).	
Custom Trajectory Status	See Custom Digital Output Settings: Custom Trajectory Status (p. 98).	
Custom Position Triggered Output	See Custom Digital Output Settings: Position Triggered Output (p. 99).	
Program Control Active High	Output state controlled by CVM or external program.	
Program Control Active Low	Output state controlled by CVM or external program	

5.6.5: Custom Digital Output Settings: Custom Event

Any of the amplifier’s digital outputs can be programmed to respond to a combination of events including faults, warnings, and status indications. The output goes active when one or more of the selected events take place.

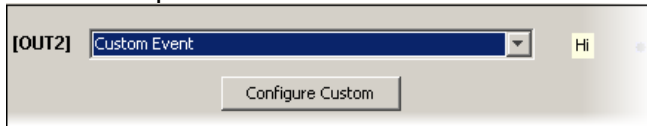

5.6.5.1

Choose **Custom Event** for an output and then click **Configure Custom** to open the *Event Configuration* screen.

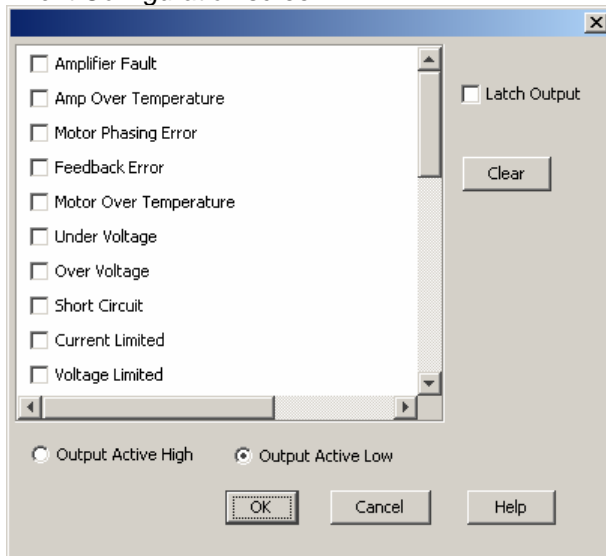

5.6.5.2

Select one or more of the faults described in [Fault Descriptions \(p. 35\)](#) or any of the following warnings or status conditions described below. Note that multiple functions are OR’ed together, so any event activates the output.

Custom Events: Warnings	
Warning	Description
Current Limited	The current output is being limited by the I ² T algorithm or a latched current fault has occurred. See I²T Time Limit Algorithm (p. 153) .
Voltage Limited	The current loop is commanding the full bus voltage in an attempt to control current. Commonly occurs when the motor is running as fast as the available bus voltage will allow.
Positive Limit Switch	Axis has contacted positive limit switch.
Negative Limit Switch	Axis has contacted negative limit switch.
Positive Software Limit	Actual position has exceeded the positive software limit setting. See Home Function (p. 144) .
Negative Software Limit	Actual position has exceeded the negative software limit setting. See Home Function (p. 144) .
Following Warning	Following error has reached programmed warning limit. See Following Error Fault Details (p. 37) .
Velocity Limit Reached	Velocity command (from analog input, PWM input, or position loop) has exceeded the velocity limit that was set as described in Velocity Loop Limits (p. 20) .
Acceleration Limit reached	In velocity mode, motor has reached an acceleration or deceleration limit that was set as described in Velocity Loop Limits (p. 20) .
Velocity Outside of Tracking Window	Difference between target and actual velocity has exceeded the window. See Tracking Window Details (p. 38) .
Position Outside of Tracking Window	The following error has exceeded the programmed value. See Tracking Window Details (p. 38) .
<i>Continued...</i>	

...Continued:	
Custom Events: Status	
Status	Description
Amplifier Disabled by Hardware	Amplifier enable input(s) is not active.
Amplifier Disabled by Software	Amplifier is disabled by a software command.
Attempting to Stop Motor	The amplifier, while in velocity or position mode, has been disabled. In velocity mode, amplifier is using the Fast Stop Ramp described in Velocity Loop Limits (p. 20) . In position mode, the amplifier is using the Abort Deceleration rate described in Trajectory Limits (p. 22) . The output remains active until the amplifier is re-enabled.
Motor Brake Activated	Motor brake activated. See Brake Operation (p. 31) for more information.
PWM Outputs Disabled	The amplifier's PWM outputs are disabled.
Home Switch is Active	Axis has contacted the home limit switch.
Not Settled	The motor is moving, or it has not yet settled after a move. The amplifier is settled when it comes within the position tracking window and stays there for the tracking time at the end of a move. Once settled, it remains settled until a new move is started.

5.6.5.3 Choose Output Active High to have the output go high when active or Output Active Low to have the output go low when active.

5.6.5.4 Latch Output To optionally latch the selected events, set **Latch Output**. For more information on latching, see [Non-Latched and Latched Custom Outputs \(p. 100\)](#).



DANGER

Latching an output does not eliminate the risk of unexpected motion with non-latched faults.

Associating a fault with a latched, custom-configured output does not latch the fault itself. After the cause of a non-latched fault is corrected, the amplifier re-enables without operator intervention. In this case, motion may re-start unexpectedly.

Failure to heed this warning can cause equipment damage, injury, or death.

5.6.5.5 Click **OK** to save changes to volatile memory and close the *Custom Output Configuration* screen.

5.6.6: Custom Digital Output Settings: Custom Trajectory Status

Any of the amplifier’s digital outputs can be programmed to respond to a combination of amplifier trajectory status conditions. The output goes active when one or more of the conditions is met.

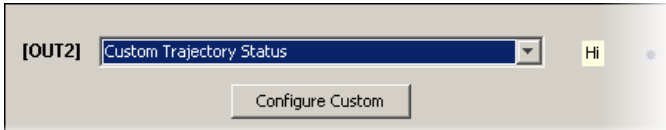

5.6.6.1

Choose **Custom Trajectory Status** for an output and then click **Configure Custom** to open the *Trajectory Status Configuration* screen.

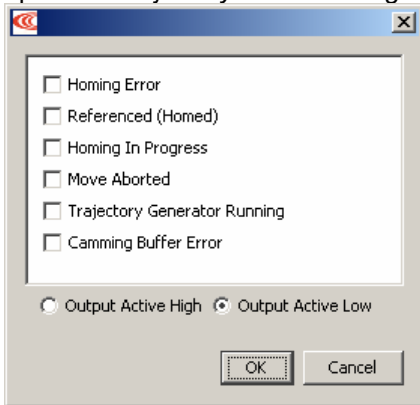

5.6.6.2

Select one or more trajectory status conditions described below. Multiple functions are OR’ed together, so any status match activates the output.

Trajectory Status Functions	
Status	Description
Homing Error	Activate output if an error occurred in the last homing attempt.
Referenced (Homed)	Activate output if the most recent homing attempt was successful.
Homing in Progress	Activate output when a homing move is in progress.
Move Aborted	Activate output if move is aborted.
Trajectory Generator Running	Activate output while trajectory generator is generating a move.
Camming Buffer Error	A camming buffer error has occurred.

5.6.6.3

Choose Output Active High to have the output go high when active or Output Active Low to have the output go low when active.

5.6.6.4

Click **OK** to save changes to volatile memory and close the screen.

5.6.7: Custom Digital Output Settings: Position Triggered Output

Any of the amplifier’s digital outputs can be programmed to respond in certain ways to the position of the controlled axis. The output goes active when the axis position meets the specified criteria.

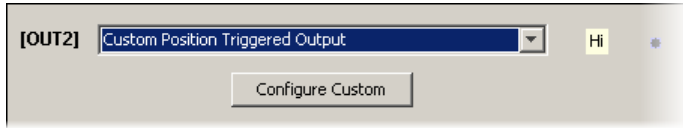

5.6.7.1

5.6.7.2 Choose **Custom Position Triggered Output** for an output and then click **Configure Custom** to open the *In Position Configuration* screen.

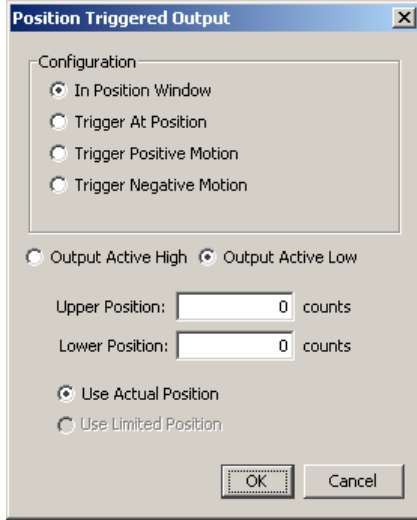

5.6.7.3 Select one of the configurations described below and enter appropriate values for the parameters.

Configuration	Description and Parameters
In Position Window	Activates the output while the axis is in the window between the programmed Upper and Lower positions.
Trigger at Position	Activates the output for the programmed Time when the axis travels through the programmed Position .
Trigger Positive Motion	Activates the output for the programmed Time when the axis travels in the positive direction through the programmed Position .
Trigger Negative Motion	Activates the output for the programmed Time when the axis travels in the negative direction through the programmed Position .

5.6.7.4 Choose Output Active High to have the output go high when active or Output Active Low to have the output go low when active.

5.6.7.5 Choose **Use Actual Position** (the Limited Position choice is for stepper amplifiers only).

5.6.7.6 Click **OK** to save changes to volatile memory and close the *Custom Output Configuration* screen.

5.6.8: Save Input/Output Changes

5.6.8.1 On the *Input/Output* screen, click **Close**.

5.6.8.2  On the *Main* screen, click **Save to Flash**.

5.6.9: Non-Latched and Latched Custom Outputs

Like an amplifier fault, a custom-configured output can be non-latched or latched.

If a non-latched, custom-configured digital output goes active, it goes inactive as soon as the last of the selected events is cleared.

If a latched output goes active, it remains active until at least one of the following actions has been taken:

- power-cycle the amplifier
- cycle (disable and then enable) an enable input that is configured as *Enables with Clear Faults* or *Enables with Reset*
-  access the CME 2 *Control Panel* and press **Clear Faults** or **Reset**
- clear faults over the CANopen network



DANGER

Latching an output does not eliminate the risk of unexpected motion with non-latched faults.

Associating a fault with a latched, custom-configured output does not latch the fault itself. After the cause of a non-latched fault is corrected, the amplifier re-enables without operator intervention. In this case, motion may re-start unexpectedly.

For more information, see [Clearing Non-Latched Faults \(p. 34\)](#).

Failure to heed this warning can cause equipment damage, injury, or death.

Custom Event Output Faults

An output configured for Custom Event can be programmed to go active in response to events, including any of the amplifier faults described in [Fault Descriptions \(p. 35\)](#).

Example: Custom Output Fault Handling vs. Overall Fault Handling

A fault on an output configured for Custom Event is separate from a fault on the amplifier. For instance, suppose:

- OUT3 has a *Custom Event* configuration. Only the *Under Voltage* fault condition is selected, and the output is latched.
- *Under Voltage* is not latched on the *Configure Faults* screen.

An under voltage condition occurs, and the amplifier goes into fault condition, output stages are disabled, and faults are reported. At the same time, OUT3 goes active.

The under voltage condition is corrected, and:

- The amplifier fault is cleared. Output stages are enabled.
- OUT3 remains active.

5.6.10: Fault Latching

5.6.10.1  Click **Configure Faults** to open the *Fault Configuration* screen.

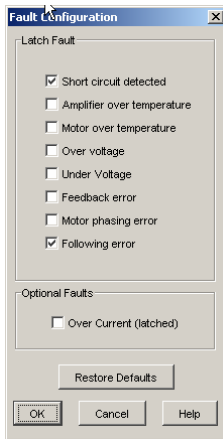

5.6.10.2 To make a fault condition latching, click to put a check mark next to the fault description.



DANGER

Risk of unexpected motion with non-latched faults.

After the cause of a non-latched fault is corrected, the amplifier re-enables the PWM output stage without operator intervention. In this case, motion may re-start unexpectedly. Configure faults as latched unless a specific situation calls for non-latched behavior. When using non-latched faults, be sure to safeguard against unexpected motion.

Failure to heed this warning can cause equipment damage, injury, or death.

For more information, see [Faults \(p. 34\)](#).

5.6.10.3 To restore factory defaults if needed, click **Restore Defaults**.

5.6.10.4 Click **OK** to save fault configuration settings to volatile memory and close the *Fault Configuration* screen.

5.6.10.5 On the *Main* screen, click **Save to Flash** (.

5.6.11: Regen Resistor

For more information on the external regen resistor, see [Regen Resistor Theory \(p. 42\)](#), and [Regen Resistor Sizing and Configuration \(p. 145\)](#).

- 5.6.11.1  Click **Configure Regen** to open the *Regen Resistor* screen.

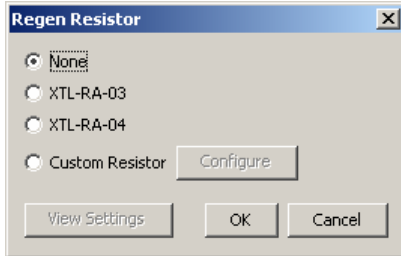

- 5.6.11.2 Select a resistor option.

Option	Description
None	No external regen resistor is used.
XTL-RA-03	Standard regen resistors supplied by Copley Controls.
XTL-RA-04	
Custom Resistor	User-supplied resistor. See Regen Resistor Sizing and Configuration (p. 145) .

- 5.6.11.3 Click **OK** to save regen settings to flash memory and close the *Regen Resistor* screen.

5.7: Command Input

Choose the appropriate step for the input format.

Input Format	Step
Analog	Analog Input (p. 104)
PWM	PWM Input (p. 106)
Digital Position	Digital Position Input (p. 107)
CAN	CAN Interface (p. 109)
ASCII	Connecting for Serial Control (p. 173), the <i>Copley Controls ASCII Interface Programmer's Guide</i> , and the <i>Copley Amplifier Parameter Dictionary</i> .

5.7.1: Analog Input

For more information, see [Analog Command Input \(p. 23\)](#).

5.7.1.1 Click **Analog Command** to open the mode-specific *Analog Command* screen.

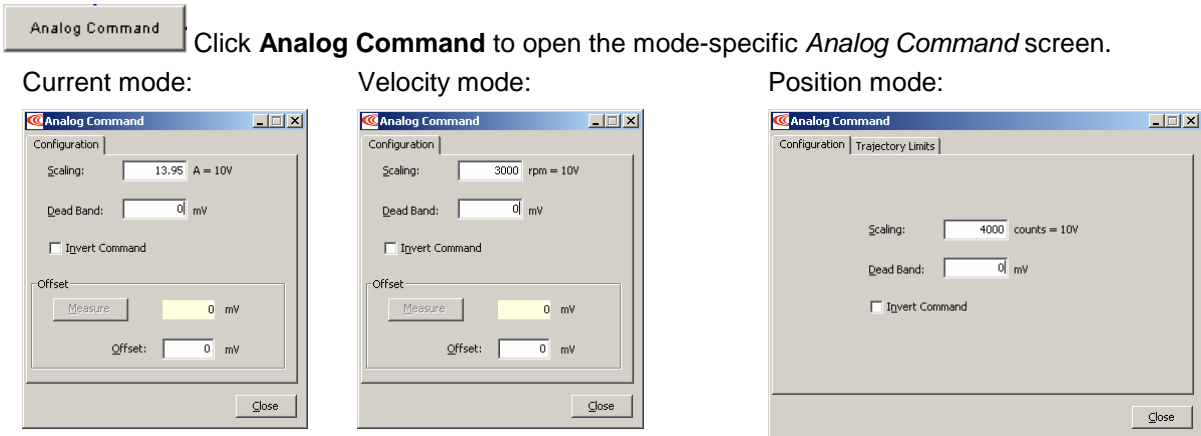

5.7.1.2 Set the input *Configuration* options described below.

Option	Description
Scaling	<p>Current mode: output current produced by +10 Vdc of input. Range: 0 to 10,000,000 A. Default: <i>Peak Current</i> value.</p> <p>Velocity mode: output velocity produced by +10 Vdc of input. Range: 0 to 100,000 rpm (mm/sec). Default: <i>Maximum Velocity</i> value.</p> <p>Position mode: position change (counts or mm) produced by +10 Vdc of input. Range: 0 to 1,000,000,000 counts. Default: 1 Revolution of a rotary motor or 1 pole pair distance for a linear motor.</p> <p>For more information, see Scaling (p. 23).</p>
Dead Band	<p>Sets dead band. Range: -10,000 to 10,000 mV. Default: 0.</p> <p>For more information, see Dead Band (p. 23).</p>
Invert Command	<p>Inverts polarity of amplifier output with respect to input signal.</p>
Offset	<p>(Current and Velocity modes only.) Used to offset input voltage error in an open loop system. Not recommended for use when the amplifier is part of a closed loop system. Range: -10,000 to 10,000 mV. Default: 0. For more information, see Offset (p. 24).</p>

5.7.1.3 In position mode, open the *Trajectory Limits* tab:

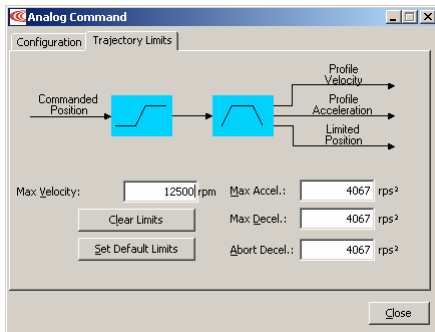

5.7.1.4 In position mode, set the *Trajectory Limits* described below:

Option	Description
Max Velocity	Maximum trajectory velocity. Max value may depend upon the back EMF and the Max feedback count. Min:0. Default: 0.25 x motor velocity limit.
Max Accel	Maximum trajectory acceleration. Max value may depend upon the load inertia and peak current. Min:0. Default: 0.5 x velocity loop <i>Accel. Limit</i> value. Setting to zero will disable trajectory limits.
Max Decel	Maximum trajectory deceleration. Max value may depend upon the load inertia and peak current. Min:0. Default: 0.5 x velocity loop <i>Accel. Limit</i> value.
Abort Decel	Deceleration rate used by the trajectory generator when motion is aborted. Min:0. Default: 0.5 x velocity loop <i>Accel. Limit</i> value.

5.7.1.5 Click **Close**.



5.7.1.6 On the *Main* screen, click **Save to Flash**.

5.7.1.7 Proceed to [Auto Phase \(p. 110\)](#).

5.7.2: PWM Input

For more information, see [PWM Input \(p. 25\)](#).

5.7.2.1



Click **PWM Command** to open the *PWM Command* screen.

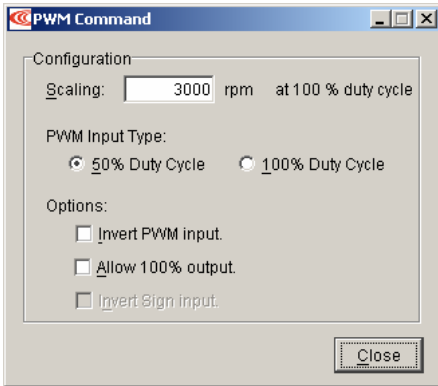

5.7.2.2

Set the input options described below.

Option	Description
Scaling	Current mode: output current at 100% duty cycle. Range: 0 to 10,000,000 A. Default: <i>Peak Current</i> value. Velocity mode: output velocity at 100% duty cycle. Range: 0 to 100,000 rpm (mm/sec). Default: <i>Maximum Velocity</i> value.
PWM Input Type	One wire 50% or two wire 100% with direction.
Options	Invert PWM input: Inverts the PWM logic. Allow 100% output: Overrides the 100% command safety measure. See Failsafe Protection from 0 or 100% Duty Cycle Commands (p. 25) . Invert Sign Input: In 100% duty cycle mode, inverts the polarity of the directional input.

5.7.2.3

Click **Close**.

5.7.2.4



On the *Main* screen, click **Save to Flash**.

5.7.2.5

Proceed to [Auto Phase \(p. 110\)](#).

5.7.3: Digital Position Input

For more information, see [Digital Input](#) (p. 26).

5.7.3.1 Click **Digital Position Inputs** to open the *Digital Position Input* screen, *Configuration* tab.

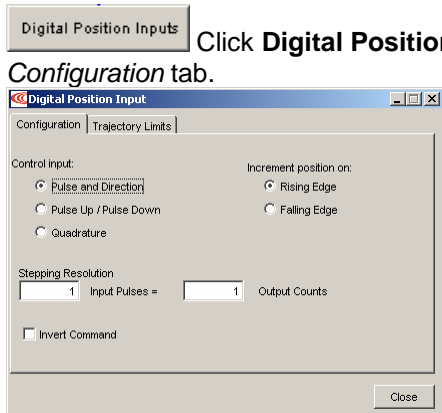

5.7.3.2 Set the options described below:

Option	Description
Control Input	<p>Pulse and Direction: One input takes a series of pulses as motion step commands, and another input takes a high or low signal as a direction command.</p> <p>Pulse Up / Pulse Down: One input takes each pulse as a positive step command, and another takes each pulse as a negative step command.</p> <p>Quadrature: A/B quadrature commands from a master encoder (via two inputs) provide velocity and direction commands.</p>
Increment position on	<p>Rising Edge: Increment position on the rising edge of the input pulse.</p> <p>Falling Edge: Increment position on the falling edge of the input pulse.</p>
Stepping Resolution	<p>Input Pulses: Number of Input Pulses required to produce output counts. Range: 1 to 32,767. Default: 1.</p> <p>Output Counts: Number of Output Counts per given number of input pulses. Range: 1 to 32,767. Default: 1.</p>
Invert Command	When selected, inverts commanded direction.

5.7.3.3 In position mode, click the *Trajectory Limits* tab.

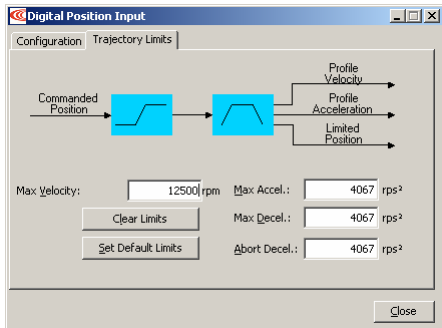

5.7.3.4 In position mode, enter the options described below:

Option	Description	For More Information
Max Velocity	Maximum trajectory velocity. Max value may depend upon the back EMF and the Max feedback count. Min:0. Default: 0.25 x motor velocity limit.	Position Mode and Position Loop (p. 22)
Max Accel	Max trajectory acceleration. Max value may depend on load inertia and peak current. Min:0. Default: 0.5 x velocity loop <i>Accel. Limit</i> value.	
Max Decel	Maximum trajectory deceleration. Max value may depend upon the load inertia and peak current. Min:0 (disables limit). Default: 0.5 x velocity loop <i>Accel. Limit</i> value.	
Abort Decel	Deceleration rate used by the trajectory generator when motion is aborted. Min:0 (disables limit). Default: 0.5 x velocity loop <i>Accel. Limit</i> value.	See Brake Operation (p. 31)

5.7.3.5 Click **Close**.



5.7.3.6 On the *Main* screen, click **Save to Flash**.

5.7.3.7 Proceed to [Auto Phase \(p. 110\)](#).

5.7.4: CAN Interface

For more information on CAN see [CANopen Operation \(p. 28\)](#).

For information on DeviceNet, see the *Copley DeviceNet Programmer's Guide*.

5.7.4.1 Verify that the following connections are wired according to the instructions in [CAN Bus \(J6\) \(p. 62\)](#):

1. J6 "CAN" CANopen cable
2. J6 "CAN" Termination plug

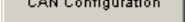
5.7.4.2  Click **CAN Configuration** to open the *CAN Configuration* screen. (If CAN is not the Position Loop Input, choose **Amplifier**→**CAN Configuration** instead.) Here is a typical *CAN Configuration* screen. (Features may vary based on amplifier model and configuration.)

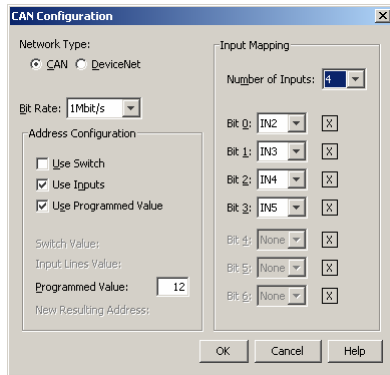

5.7.4.3 Set **Network Type** to **CAN**.

5.7.4.4 Choose a Bit Rate and choose any combination of address sources (Switch, Inputs, and Programmed Value). The address is the sum of the values from these sources. See [CAN Addressing \(p. 29\)](#).

5.7.4.5 For each source selected, perform the additional steps described below.

Source	Additional Steps
Use Switch	Verify the S1 switch setting. (Assigns values for Bit 0 – Bit 3 of CAN address.)
Use Inputs	Enter the Number of inputs . Choose the input that will represent each CAN address bit.
Use Programmed Value	Enter the Programmed value .

5.7.4.6 Click **OK** to close the screen and save the changes to flash.

NOTE: CAN address and bit rate are changed only after power-up or reset.

5.8: Auto Phase

5.8.1: Auto Phase Warnings and Notes

Warnings



Danger

Motor Motion

Applying AC power to the amplifier may result in motor motion. Be sure that motor motion will not cause injury.

Failure to heed this warning can result in equipment damage, injury, or death.



Danger

High Voltage

Applying AC power to the amplifier applies high voltage to the amplifier-motor connections and cabling. Protect personnel against electrical shock.

Failure to heed this warning can result in equipment damage, injury, or death.

Notes

- Do not connect a load to the motor before performing Auto Phase procedure.
- Always connect the motor using the same configuration.
- Wire properly and consistently.
- Connections are actually changed within the DSP, not at the motor terminals, and the results are saved to flash memory. The actual wire configuration should NEVER change.
- Brushless motors require two electrical cycles for auto phasing.

Phasing accomplishes several objectives:

- Checks the encoder or resolver and establishes proper commutation.
- Checks the motor power wires for proper connection and establishes proper phasing.
- Checks the Hall switches and establishes proper commutation.

5.8.2: Auto Phase Procedure

NOTE: The following steps use a brushless rotary motor. Screens and sequences vary by motor type.

5.8.2.1 Verify that the Enable Input is not activated.

5.8.2.2 Apply HV or AC power.

 Click **Auto Phase** to open the *Auto Phase Motor Direction Setup* screen.

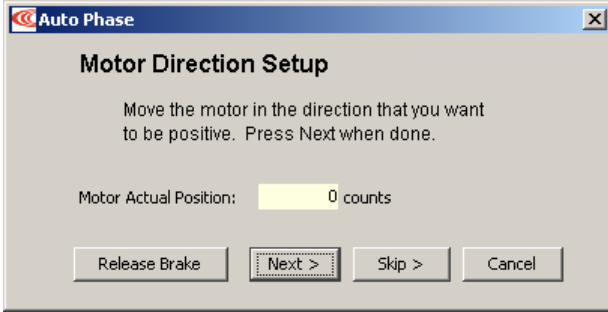

5.8.2.3 Move the motor in the direction to be considered positive OR if you cannot move the motor, click **Skip** (you will confirm motor direction later). NOTE: If an output is configured as a brake you can temporarily release the brake by holding down the **Release Brake** button. The brake will be reactivated when you release the button..

The Actual Position value on the screen should change. If it does not change, see Trouble Shoot Motor Direction Setup (p. 115).

5.8.2.4 Click **Next** to display the *Auto Phase Motor Wiring Setup* screen.

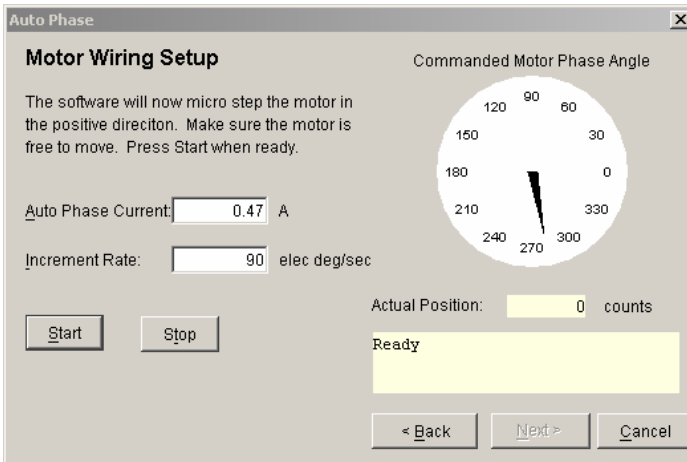

5.8.2.5 Activate the Enable Input.

5.8.2.6 Click **Start** to begin the motor wiring setup.

The software displays messages: *Configuring Initial Settings, Microstepping, Test Complete, Motor Wiring has been configured.*

During microstepping, a current vector is applied to the motor windings and microstepped through an electrical cycle at a set rate, causing the motor to move.

If you chose to **Skip** the motor direction setup step, Auto Phase will prompt for confirmation of correct motor direction.

If the step fails see [Trouble Shoot Motor Wiring Setup \(p. 115\)](#).

NOTE: If incorrect values were entered for inductance and resistance, the calculated Cp and Ci values may produce current loop oscillation, evidenced by an audible high frequency squeal during auto phasing.

5.8.2.7 Click **Next** to open the *Auto Phase Phase Count Test* screen.

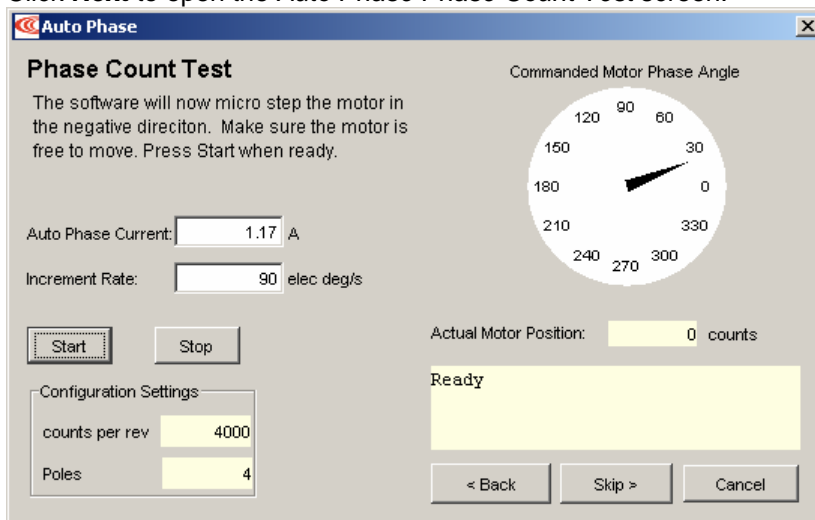

5.8.2.8 Click **Start** to begin the Phase Count Test. Observe status messages. See the prompt:

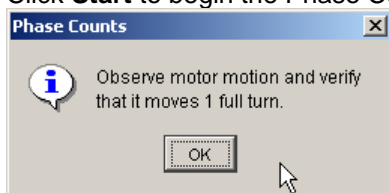

5.8.2.9 When you are ready to observe motion, click **OK**. See the prompt:

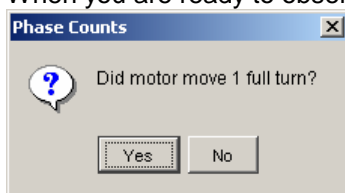

5.8.2.10 If motor did not turn 1 full turn, click **No** and verify that in the Motor/Feedback screen the following parameters have been set correctly:

- Number of Poles for rotary motors.
- Magnetic Pole Pair Length for linear motors
- Encoder Lines or Fundamental Lines for rotary encoders.

- 5.8.2.11 Encoder Resolution for linear encoders.
- 5.8.2.12 If motor turned 1 full turn, click **Yes**.
- 5.8.2.13 For a -R version of Xenus with a resolver, skip to [5.8.2.16](#).
- 5.8.2.14 For a non-resolver Xenus, click **Next** to display the *Halls Wiring Setup* screen.

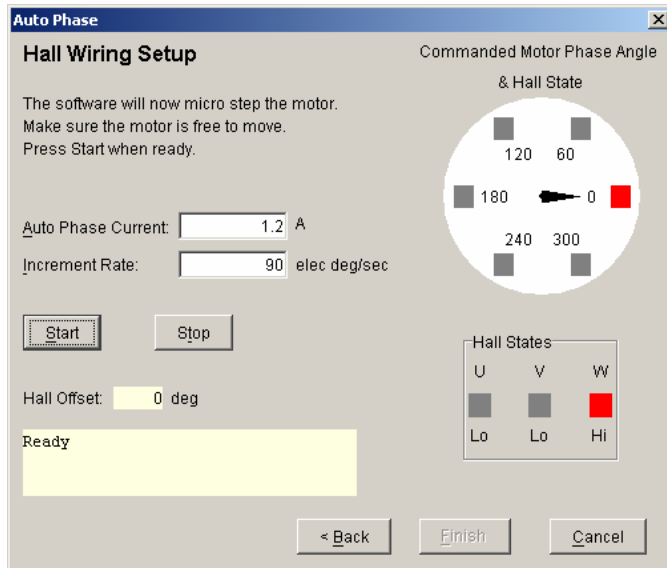

- 5.8.2.15 Click **Start** to begin the Halls wiring setup. The message area displays the messages: *Microstepping. Test Complete. Motor has been properly phased.*

During microstepping, a current vector is applied to the motor windings and microstepped through an electrical cycle at a set rate. The field produced should push on the permanent magnet's magnetic field causing the motor to move. As the motor moves the Hall lines are decoded for proper commutation.

If the step fails, see [Trouble Shoot Halls Wiring Setup \(p. 115\)](#).

- 5.8.2.16 For a resolver (-R) version of Xenus, click **Next** to open the Resolver Phase Angle Setup screen.

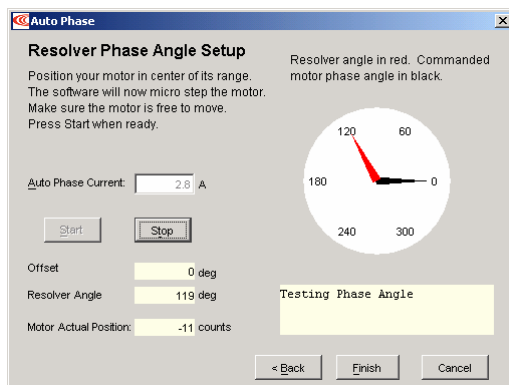

- 5.8.2.17 Click **Start** to start the resolver phase angle setup. The message area displays status messages.

- 5.8.2.18 Click **Finish** to close the screen and save values to flash memory
OR
to close the screen without saving changes, click **Cancel**.
- 5.8.2.19 If the Auto Phase algorithm does not produce desired results, try adjusting the Auto Phase Current and Increment Rate values, using the guidelines in [Guidelines for Choosing Auto Phase Current and Increment Rate Values \(p. 115\)](#).
- 5.8.2.20 If desired results are not obtained, see “Manual Phasing” in the *CME 2 User Guide*.

5.8.3: Guidelines for Choosing Auto Phase Current and Increment Rate Values

Here are some considerations in choosing Auto Phase Current and Increment Rate values:

- If friction is high, then more current may be required to move the load.
- High static friction may require more current to overcome stiction.
- Transition from static friction to dynamic friction, and back, may produce jerky motion.
- A faster rate will operate in the dynamic friction range.
- A slower rate will operate in the static friction range.
- If the friction is low, as in the case of air bearings, low frequency oscillations may occur; thus, less current and slower rates may be required. If oscillations persist, then friction may need to be temporarily added.

5.8.4: Trouble Shoot Motor Direction Setup

If motor direction setup step failed:

- 5.8.4.1 Check Encoder or resolver power and signals.
- 5.8.4.2 Verify that the encoder is differential. (Contact factory if encoder is single-ended.)
- 5.8.4.3 Check shielding for proper grounding.

5.8.5: Trouble Shoot Motor Wiring Setup

If motor wiring setup step failed:

- 5.8.5.1 Verify that amplifier is disabled.
- 5.8.5.2 Check for mechanical jamming.
- 5.8.5.3 Check for smooth motion with no mechanical jerking.
- 5.8.5.4 Check for good connections to the motor power wires.
- 5.8.5.5 Disconnect motor power wires.
- 5.8.5.6 Measure for proper motor resistance.

5.8.6: Trouble Shoot Halls Wiring Setup

If Halls wiring setup step failed:

- 5.8.6.1 Check Halls power and signals.
- 5.8.6.2 Check for smooth motion with no mechanical jerking.
- 5.8.6.3 Check shielding for proper grounding.

5.8.7: Trouble Shoot Other Problems

If the auto phase procedure fails despite these corrective measures, see “Manual Phasing” in the *CME 2 User Guide*.

5.9: Current Loop

Initial current loop proportional gain (**Cp**) and current loop integral gain (**Ci**) values were calculated in a [previous step](#). For an introductory overview of the control loops, see [Operating Modes \(p. 17\)](#).

NOTE: For Copley Controls digital amplifiers, the current loop gain is independent of the power supply voltage.

5.9.1: Current Loop Settings

For more information, see [Current Mode and Current Loop \(p. 18\)](#).

5.9.1.1 Click I Loop to open the *Current Loop* screen:

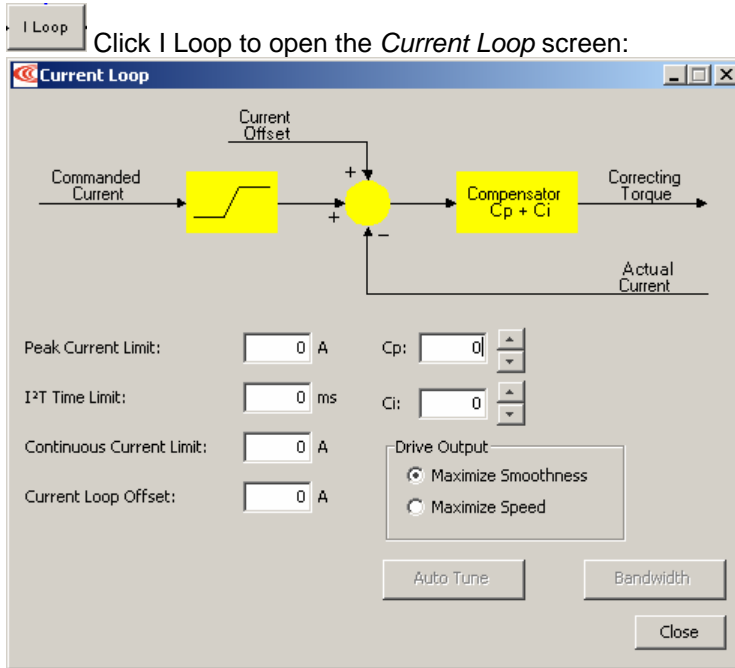

5.9.1.2 Change/verify Current Loop parameters as needed.

Parameter	Description
Peak Current Limit	Used to limit the peak phase current to the motor. Max value depends upon the amplifier model; Min value > continuous limit.
I ² T Time Limit	Sets I ² T Time Limit in mS. See I²T Time Limit Algorithm (p. 153) .
Continuous Current Limit	Used to limit the Phase Current. Max Value is < <i>Peak Current</i> and depends upon the amplifier model. Min value: 0
Current Loop Offset	Sets current loop offset. Leave it set to zero until after tuning. For more information, see Offset (p. 18) .
Cp	Current loop proportional gain. Range 0 – 32,767.
Ci	Current loop integral gain. Range 0 – 32,767.
Drive Output	Maximize Smoothness: Amplifier uses circular vector limiting to produce smooth operation even into the voltage limits. Maximize Speed: Allows for slightly more of the bus voltage to be used when in the voltage limit. This may produce a small disturbance at top speed.
Auto Tune	See Auto Tune the Current Loop (p. 117) .
Bandwidth	Measure bandwidth using the Cp and Ci values now in the amplifier.

5.9.2: Auto Tune the Current Loop

(For instructions on manually tuning the current loop, see the *CME 2 User Guide*.)

The current loop auto tune algorithm applies a square-wave command to the current loop and adjusts current loop proportional gain (C_p) and current loop integral gain (C_i) until a desirable waveform is obtained.

Initial current loop proportional gain (C_p) and current loop integral gain (C_i) values can be calculated with [The Calculate Function](#) (p. 92).

- 5.9.2.1 Verify that the following steps in [Quick Setup with CME 2](#) (p. 73) have been performed: Prerequisites, Basic Setup, Motor/Feedback Setup, Amplifier Configuration, Command Input, Auto Phase.

- 5.9.2.2  Click **I Loop** to open the *Current Loop* screen:

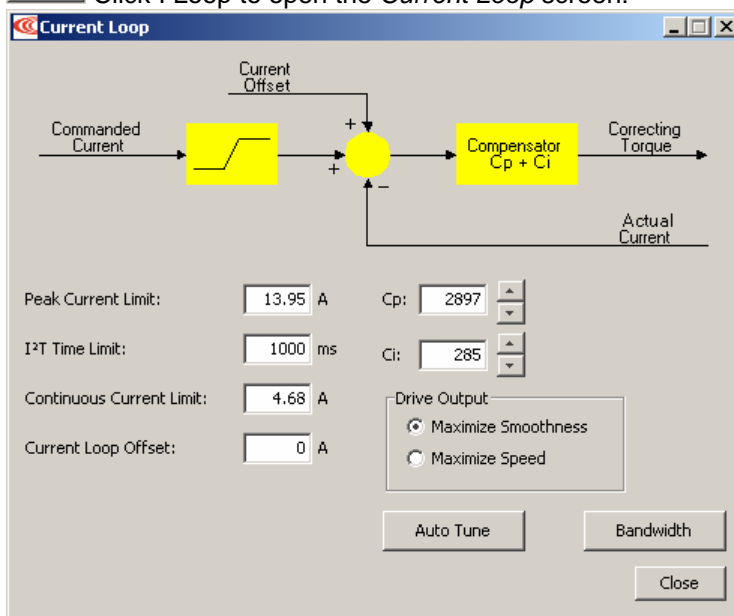

- 5.9.2.3 Verify that amplifier is hardware enabled.

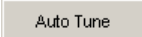
- 5.9.2.4  Click **Auto Tune** to open screen and start the Current Loop Auto Tune.

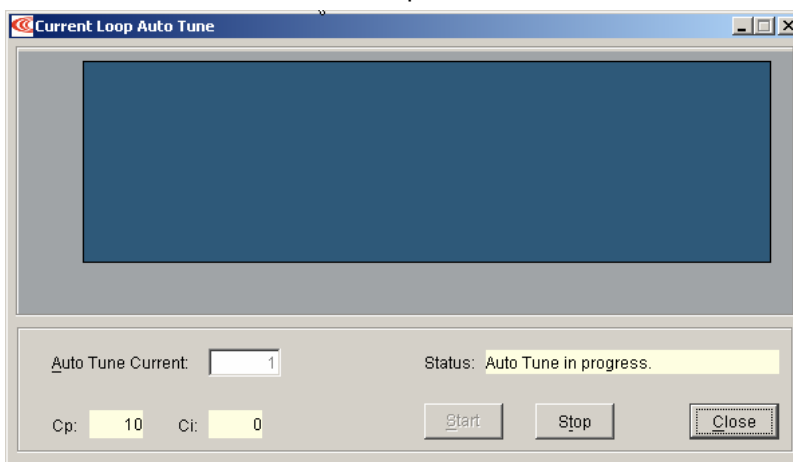

- 5.9.2.5 To Change the Auto Tune Current, Press **Stop**, enter the new current in the *Auto Tune Current* field, and then press **Start**.

5.9.2.6 Observe the auto tune process and results.

Auto Tune uses a proprietary algorithm to mimic a standard tuning approach that would be used by a trained technician, as described below:

- 1 Sets C_p and C_i to zero and then adjusts C_p and C_i for optimal values.

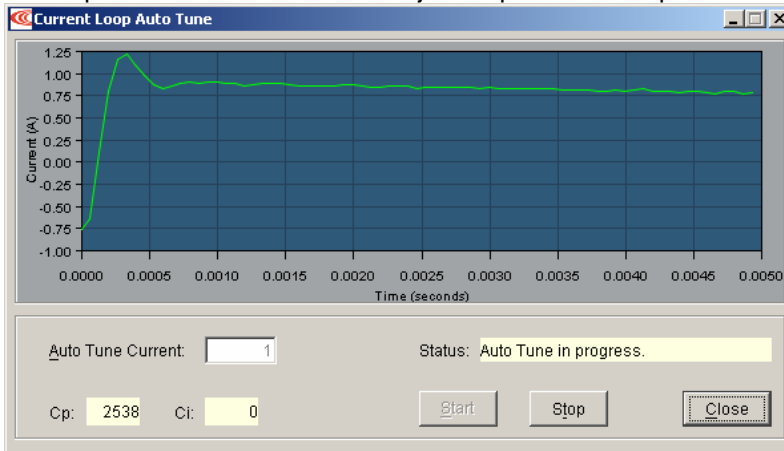

- 2 Uses a frequency sweep to determine the small signal, current loop bandwidth.



- 3 Displays the results: a set of C_p , C_i , and bandwidth value alternatives.

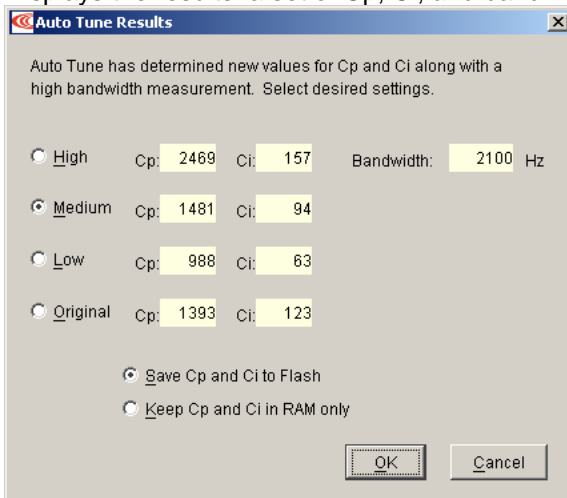

5.9.2.7 Choose an action based on Auto Tune results.

- 1 Optionally choose which set of values to save: *High, Medium, Low, or Original*. The *Medium* values, selected by default, are appropriate for most applications.
- 2 Optionally choose how to save: **Save Cp and Ci to Flash** or **Keep Cp and Ci in RAM only**.
- 3 Click **OK** to save the values as chosen, and close the *Auto Tune Results* window or click **Cancel** to close the window without saving any changes.

5.10: Velocity Loop

Initial velocity loop proportional gain (**Vp**) and velocity loop integral gain (**Vi**) values were calculated in a [previous step](#).

5.10.1: Velocity Loop Settings

For more information, see [Velocity Mode and Velocity Loop \(p. 20\)](#).

5.10.1.1 Click V Loop.

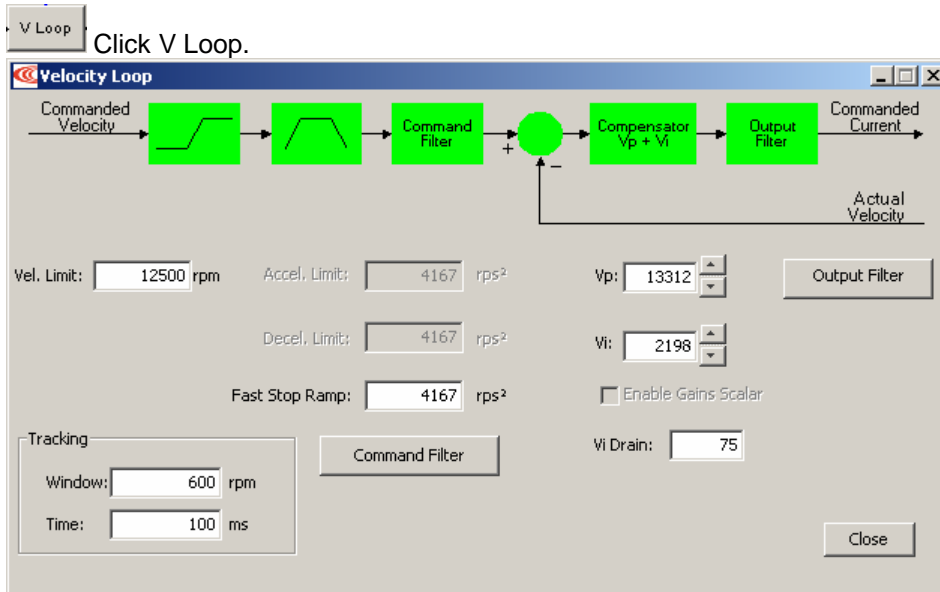

5.10.1.2 Change/verify Velocity Loop parameters as needed.

Parameter	Description
Velocity Limit	Top speed limit. Max value may depend upon the back EMF & the Encoder value. Min value: 0.
Acceleration Limit	Maximum acceleration rate. Max value may depend upon load, inertia, & peak current. Min value: 1. (Does not apply in position mode.)
Deceleration Limit	Maximum deceleration rate. Max value may depend upon load, inertia, & peak current. Min value: 1. (Does not apply in position mode.)
Tracking Window	See Tracking Window Details (p. 38) .
Tracking Time	
Vp	Velocity loop proportional gain. Range: 0 to 32,767.
Vi	Velocity loop integral gain. Range: 0 to 32,767.
Fast Stop Ramp	Deceleration rate used by the velocity loop when the amplifier is hardware disabled. Range: 0 to 100,000,000. Default: velocity loop <i>Decel. Limit</i> value. For more information, see Velocity Loop Limits (p. 20) .
Enable Gains Scalar	Increases the resolution of the units used to express Vp and Vi, providing more precise tuning. For more information, see Velocity Loop Gains Scalar (p. 21) .
Vi Drain (integral bleed)	Vi drain modifies the effect of velocity loop integral gain. The higher the Vi Drain value, the faster the integral sum is lowered. Range: 0 to 32,000. Default: 0.
Command Filter	Programmable command input filter. Disabled by default. For more information on the velocity loop filters, see the <i>CME 2 User's Guide</i> .
Output Filter	Programmable output filter. Default filter type: Low-Pass, 2-pole Butterworth (Cut Off Frequency 200 Hz). For more information on the velocity loop filters, see the <i>CME 2 User Guide</i> .

5.10.2: Manually Tune the Velocity Loop

To tune the velocity loop, apply square-wave excitation to the velocity loop and adjust velocity loop proportional gain (**Vp**) and velocity loop integral gain (**Vi**) to obtain a desired waveform. For instance:

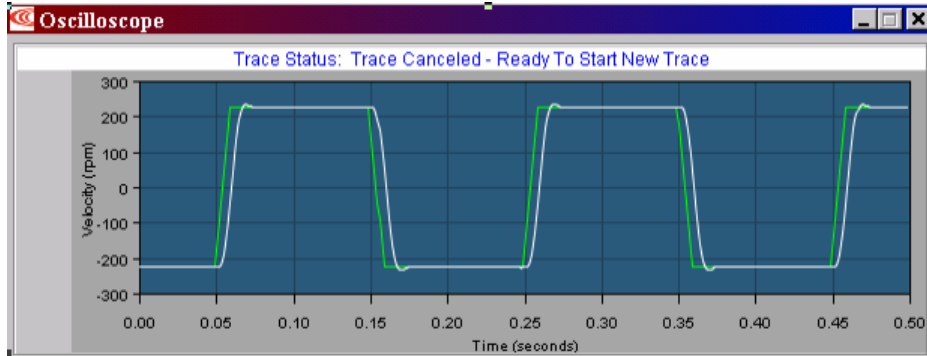

NOTE: During tuning, observe any warnings that appear to the left of the trace.

5.10.2.1  Click the Scope Tool to open the *Oscilloscope* window.

5.10.2.2  Choose **Velocity** from the Function Generator *Apply To:* list.

Auto Setup On the *Settings* tab, make sure **Auto Setup** is selected. Auto Setup automatically sets the following parameters:

Function Generator Tab	
Parameter	Description
Excitation	Square Wave
Amplitude	10% of maximum velocity value.
Frequency	5 Hz
Settings Tab	
Channel 1	Limited velocity (green)
Channel 2	Actual velocity (white)

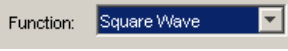
5.10.2.3  Verify that Amplitude value is not excessive for the motor.

5.10.2.4  Click **Start**.

5.10.2.5 On the *Gains* tab, adjust velocity loop proportional gain (**Vp**).

- 1 Set velocity loop integral gain (**Vi**) to zero.
- 2 Raise or lower velocity loop proportional gain (**Vp**) until desired step response is obtained. Typically, this means little or no overshoot on a 5 Hz small, slow-speed square wave.

5.10.2.6 Adjust velocity loop integral gain (**Vi**) until desired settling time is obtained.

5.10.2.7  Press **Stop** to stop the function generator.

5.10.2.8  On the Main screen, click **Save to Flash** to avoid losing the changes.

5.10.2.9 If the amplifier is to be operated in velocity mode, skip the position loop setup procedures and go to [Completion Steps](#) (p. 126).

5.11: Position Loop

Initial position loop proportional gain (Pp), velocity feed forward (Vff), and acceleration feed forward (Aff) values were calculated in a [previous step](#).

5.11.1: Position Loop Settings

For more information, see [Position Mode and Position Loop \(p. 22\)](#).

5.11.1.1 Click P Loop to open the screen:

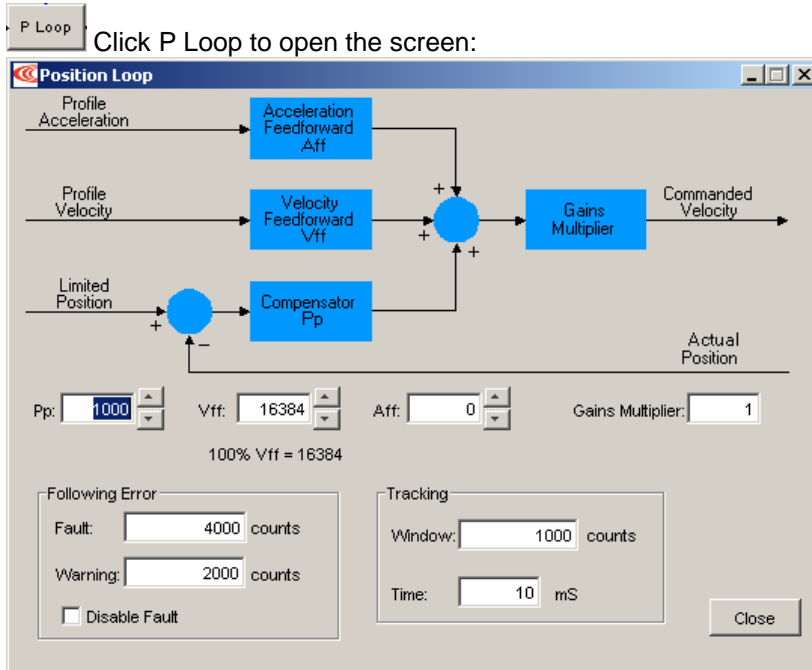

5.11.1.2 Change/verify Position Loop parameters as needed:

Option	Description	For More Information...
Gains		
Aff	Acceleration feed forward. Range: 0 to 32,767.	Trajectory Limits (p. 22)
Vff	Velocity feed forward. Range: 0 to 32,767. 100% Vff: 16,384.	
Pp	Position loop proportional gain. Range: 0 to 32,767.	
Gains Multiplier	Position loop output is multiplied by this value before going to the velocity loop. In dual encoder systems, the multiplier's initial value is calculated based on the ratio of motor encoder turns to position encoder turns.	See Feedback Parameters, Rotary (p. 88) for information on motor/position encoder ratio.
Following Error		
Fault	The level (in encoder counts) at which the following error produces a fault, which stops the servo loop. We recommend raising the fault level before tuning the loop.	Following Error Fault Details (p. 37) .
Warning	The level (in encoder counts) at which the following error produces a warning (without stopping the servo loop).	
Disable Fault	Prevents following error from triggering a fault.	
Tracking		
Tracking Window	Width of the tracking window in counts.	Tracking Window Details (p. 38) .
Tracking Time	Position must remain in the tracking window for this amount of time to be considered tracking.	

5.11.2: Manually Tune the Position Loop

To tune the position loop, minimize following error and oscillation by running profiles and adjusting position proportional gain (**Pp**), velocity feed forward (**Vff**), acceleration feed forward (**Aff**) and other settings. For instance:

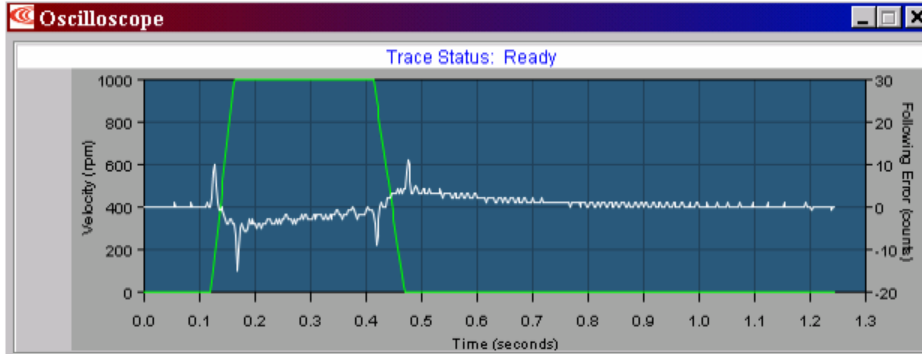

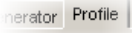
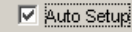

NOTE: During position loop tuning, observe any warnings that appear to the left of the trace.

5.11.2.1 Perform an auto setup test:

- 1  Click the Scope Tool to open the *Oscilloscope* window.
- 2  Select the *Profile* tab.
- 3  On the *Settings* tab, make sure that **Auto Setup** is checked. Auto Setup automatically sets the following options:

Profile Tab	
Parameter	Description
Move	Relative
Type	Trap
Distance	2000 counts
Reverse and repeat	Not selected
Settings Tab	
Channel 1	Profile velocity (green)
Channel 2	Following error (white)

- 4  If the auto setup default profile distance is not appropriate, enter an appropriate short distance.
- 5  Click **Start**.
The Profile Generator executes a short move.

NOTES:

- 1 The profile may not reach constant velocity during a short move.
- 2 If a following error occurs, open the CME 2 *Control Panel* () and click **Clear Faults**.

5.11.2.2 Set up a trapezoidal profile by setting the trajectory limits and distance. See table:

Trajectory Limits Tab	
Parameter	Description
Maximum Velocity	Set values typical of those expected to be used in the application.
Maximum Acceleration	
Maximum Deceleration	
Profile Tab	
Distance	Set the move distance to produce a complete trajectory profile. Be sure that this distance does not exceed mechanical limits of the system.
Move	Relative
Type	Trap

5.11.2.3 Adjust position proportional gain (**Pp**) to minimize following error. Note that too much position loop proportional gain (**Pp**) might cause oscillation.

- 1 On the *Gains* tab, set velocity feed forward (**Vff**) and acceleration feed forward (**Aff**) to zero.
- 2 On the *Profile* tab, click **Start**. On the *Gains* tab, adjust position loop proportional gain (**Pp**) until best result is obtained.
- 3 Click **Start** after each adjustment to test the new value on a new profile move.

NOTE: If a following error occurs, open the CME 2 *Control Panel* () and click **Clear Faults**.

5.11.2.4 Adjust velocity feed forward (Vff):

Velocity feed forward (**Vff**) reduces following error in the constant velocity portion of the profile. Often, a velocity feed forward (**Vff**) value of 16384 (100%) provides best results.

- 1 Click in the *Vff* field and adjust the value.
- 2 Click **Start** after each adjustment to test the new value on a new profile move.

5.11.2.5 Adjust acceleration feed forward (Aff):

Acceleration feed forward (**Aff**) reduces following error during profile acceleration and deceleration.

- 1 Click in the *Aff* field and adjust the value.
- 2 Click **Start** after each adjustment to test the new value on a new profile move.

NOTES:

- 1 If, after tuning the position loop, the motor makes a low frequency audible noise while enabled but not moving, the velocity loop gains (*Vp* and *Vi*) may be lowered to reduce the noise. If the gain values are set too low, the response to instantaneous rates of change might be reduced (i.e., slow correction to disturbances or transients).
- 2 If the amplifier is set up to run in position mode under analog input command, and the analog command signal produces too much noise at the motor after tuning, the Velocity Loop Command Filter may be used to reduce the noise further. See the CME 2 User Guide for more information about the velocity loop filters.

5.11.2.6 Tune to multiple sets of profiles representing typical moves that might be executed in the application. Starting with [Set up a trapezoidal profile](#), repeat the process as needed.

5.11.3: Test S-Curve Profile

NOTE: Skip this step unless the amplifier will perform CANopen S-Curve profile moves.

Jerk is the rate of change of acceleration. S-Curve moves reduce jerk to provide a smooth profile. To tune the level of jerk, run an S-Curve profile and adjust velocity, acceleration, deceleration, and jerk levels until the desired profile is obtained. For instance:

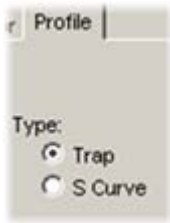
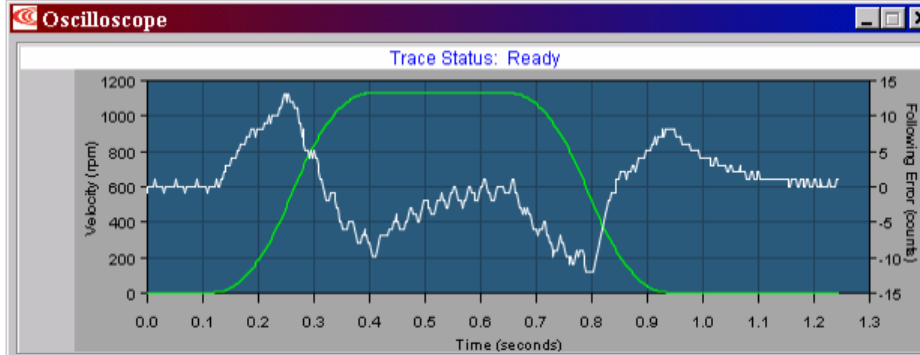

5.11.3.1 On the *Profile* tab, click the **S-Curve** button.

5.11.3.2 Adjust the following options. Set values that represent a typical move under normal operation.





Trajectory Limits Tab	
Parameter	Description
Maximum Velocity	Maximum speed of the profile.
Maximum Acceleration/Deceleration	Maximum acceleration/deceleration of the profile. The deceleration is set to be the same as acceleration.
Maximum Jerk	The value of jerk set during the calculate procedure produces an S-Curve whose maximum slope is equal to the trajectory profile slope. This value will produce a maximum acceleration that is not more than the initial default value of acceleration. Small values will produce less jerking but will take longer to complete move. Large values will produce more jerking and a more trapezoidal profile but will complete the move faster.
Profile Tab	
Distance	Increase the move distance to produce a complete trajectory profile. Use an acceptable value the does not exceed mechanical limits of the system.
Move	Relative
Type	S-Curve

5.12: Completion Steps

5.12.1: Objective

Save the work and perform additional testing with load and under normal control source.

5.12.2: Steps

- 5.12.2.1  On the *Main* screen, click **Save to Flash**.
- 5.12.2.2 Remove AC power from connector J1.
- 5.12.2.3 Attach load.
- 5.12.2.4 Reconnect AC power to connector J1.
- 5.12.2.5 Re-tune velocity and position loops if applicable.
- 5.12.2.6  On the *Main* screen, click **Save to Flash**.
- 5.12.2.7  On the *Main* screen, click **Save to Disk** (for backup or duplication).
- 5.12.2.8  Click **Control Panel** and then click **Reset**
OR
Power-cycle the amplifier.
- 5.12.2.9 The amplifier tuning procedure is complete.

CHAPTER

6: USING CME 2

This chapter provides an overview of CME 2 software features. Contents include:

Title	Page
6.1: CME 2 Overview.....	128
6.1.1: Main Screen Overview.....	128
6.1.2: Tool Bar Overview.....	128
6.1.3: Main Menu Overview.....	129
6.1.4: Functional Diagram.....	131
6.1.5: CAN or DeviceNet Information and Status Bar.....	132
6.1.6: Choosing an Amplifier from a List of Amplifiers.....	132
6.1.7: Renaming an Amplifier.....	132
6.2: Manage Amplifier and Motor Data.....	133
6.2.1: Memory.....	133
6.2.2: Disk Storage.....	133
6.2.3: Data Management Tools.....	134
6.2.4: Quick Copy Setup Procedure.....	135
6.3: Downloading Firmware.....	136
6.3.1: Acquiring Firmware from Web Site (Optional).....	136
6.3.2: Downloading Firmware to Amplifier.....	137
6.4: Control Panel.....	138
6.4.1: Control Panel Overview.....	138
6.4.2: Status Indicators and Messages.....	138
6.4.3: Control Panel Monitor Channels.....	140
6.4.4: Control Functions.....	141
6.4.5: Jog Mode.....	141
6.5: Manual Phasing.....	142
6.5.1: Manual Phase Objectives.....	142
6.5.2: Manual Phase Instructions, Quad A/B Encoder XTL Xenus.....	142
6.6: Home Function.....	144
6.6.1: Overview.....	144
6.6.2: Homing Functions Settings.....	144

6.1: CME 2 Overview

6.1.1: Main Screen Overview

CME 2 features are called out in the diagram below. Screen details vary depending on amplifier model and mode selection. Details follow in the chapter.

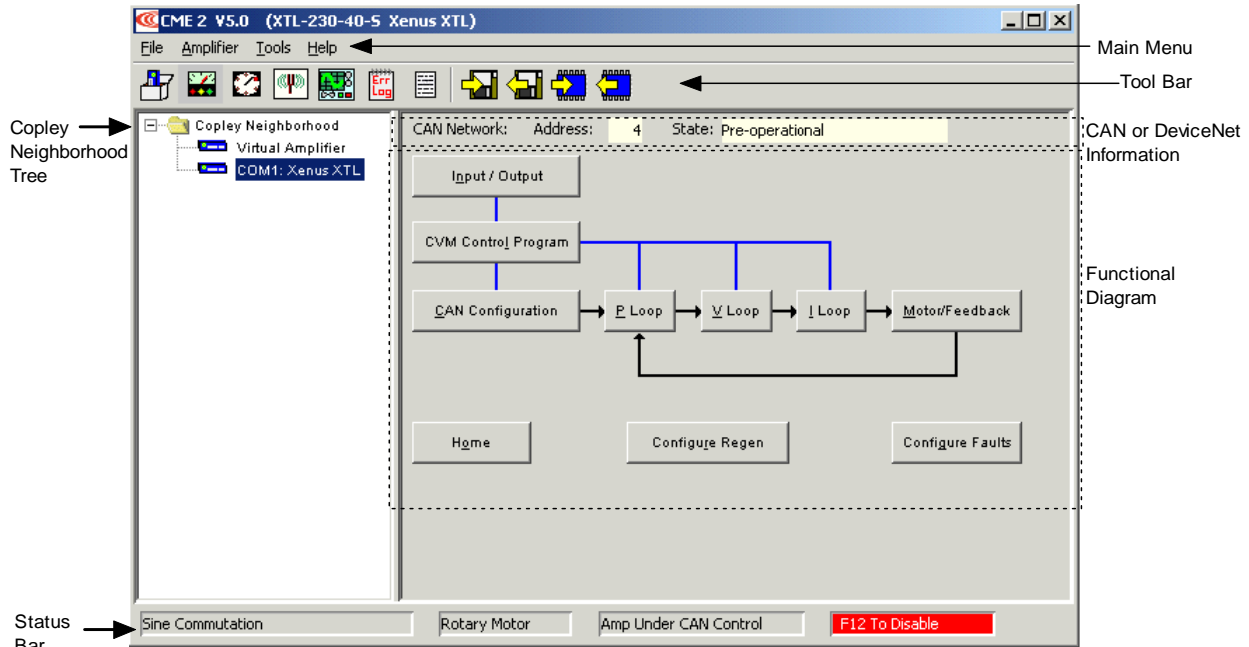

6.1.2: Tool Bar Overview

Click on any of the tools in the toolbar to access the tools described below.

Icon	Name	Description	For More Information
	Basic Setup	Opens <i>Basic Setup</i> screen.	Basic Setup (p. 81).
	Control Panel	Opens <i>Control Panel</i> .	Control Panel (p. 138).
	Auto Phase	Opens <i>Auto Phase</i> tool.	Auto Phase (p. 110).
	Auto Tune	Opens <i>Auto Tune</i> for Linear Servo Motors.	<i>CME 2 User Guide.</i>
	Scope	Opens <i>Scope</i> .	<i>CME 2 User Guide.</i>
	Error Log	Opens <i>Error Log</i> .	<i>CME 2 User Guide.</i>
	Amplifier Properties	Displays basic amplifier properties.	
	Save amplifier data to disk	Saves contents of amplifier RAM to a disk file.	Manage Amplifier and Motor Data (p. 133).
	Restore amplifier data from disk	Restores an amplifier file from disk to amplifier RAM.	
	Save amplifier data to flash	Saves contents of amplifier RAM to flash memory.	
	Restore amplifier data from flash	Restores contents of flash memory to amplifier RAM.	

6.1.3: Main Menu Overview

The CME 2 Main Menu choices are described below.

Menu	Selection	Description	For More Information
File	Save Amplifier Data	Saves contents of amplifier's RAM to a disk file.	Manage Amplifier and Motor Data (p. 133).
	Restore Amplifier Data	Restores contents of an amplifier file from disk to amplifier RAM.	
	Restore CVM Control Program	Prompts for a Copley Virtual Machine program file. The program in this file will replace the current program in flash. This procedure also results in the setting of the Indexer 2 Program option Enable Control Program on Startup. This configures the program to auto start when the amplifier is powered up or reset.	<i>Copley Indexer 2 Program User Guide.</i>
	Restore Cam Tables	Prompts for a saved Cam Table file (.cct file). All tables in amplifier flash will be replaced by the ones in this file.	See <i>Copley Camming Users Guide.</i>
	Exit	Closes CME 2. Prompts for data-saving decision.	
Amplifier	Basic Setup	Opens <i>Basic Setup</i> screen.	Basic Setup (p. 81).
	Control Panel	Opens <i>Control Panel</i> .	Control Panel (p. 138).
	Auto Phase	Opens <i>Auto Phase</i> tool.	Auto Phase (p. 110).
	Scope	Opens <i>Scope</i> .	<i>CME 2 User Guide.</i>
	Error Log	Opens <i>Error Log</i> .	<i>CME 2 User Guide.</i>
	Amplifier Properties	Displays basic amplifier properties.	
	CAN/DeviceNet Configuration	Opens the CAN or DeviceNet Configuration screen.	
	Rename	Prompts for new amplifier name.	Renaming an Amplifier (p. 132).
	Auto Tune	<i>Auto Tune</i> for Linear Servo Motors.	<i>CME 2 User Guide.</i>
Tools	Communications Wizard	Starts sequence of prompts to set up serial port.	Serial Port Setup (p. 77).
	Communications Log	Opens <i>Communications Log</i> .	<i>CME 2 User Guide.</i>
	Download Firmware	Starts prompts to download new firmware image from disk to amplifier.	Downloading Firmware (p. 136).
	Download CPLD Program	Starts prompts to download PLD code from disk to amplifier.	
	Download FPGA Program	Starts prompts to download FPGA code from disk to amplifier.	
	Firmware Recovery	Starts prompts to recover amplifier when a firmware download was interrupted.	<i>CME 2 User Guide.</i>
	Manual Phase	Opens <i>Manual Phase</i> tool.	<i>CME 2 User Guide.</i>
	View Scope Files	Opens <i>Trace Viewer</i> window.	<i>CME 2 User Guide.</i>
	I/O Line States	Opens I/O Line States window.	
	CME 2 Lock/Unlock	Opens screen for locking and unlocking CME 2 functionality.	<i>CME 2 User Guide.</i>
	ASCII Command Line	Opens screen to accept ASCII format commands.	<i>CME 2 User Guide.</i>
<i>Continued...</i>			

<i>...continued:</i>		
Menu	Selection	Description
Help	CME 2 User Guide	Opens the <i>CME 2 User Guide</i> .
	All Documents	Opens the Doc folder in the CME 2 installation folder (typically <i>c://Program Files/Copley Motion/CME 2/Doc</i>). This folder contains all of the related documents that were installed with CME 2.
	Downloads Web Page	Opens default web browser with relevant pages from Copley Controls' website.
	Software Web Page	
	View Release Notes	Opens latest CME 2 release notes in a text viewer.
	About	Displays CME 2 version information.

6.1.4: Functional Diagram

The functional diagram, shown below, provides button-click access to most of the screens used to configure an amplifier. It also indicates the flow of control from input, across all active control loops, to motor/feedback. Only those control loop buttons that are appropriate to the operational mode appear on the diagram.

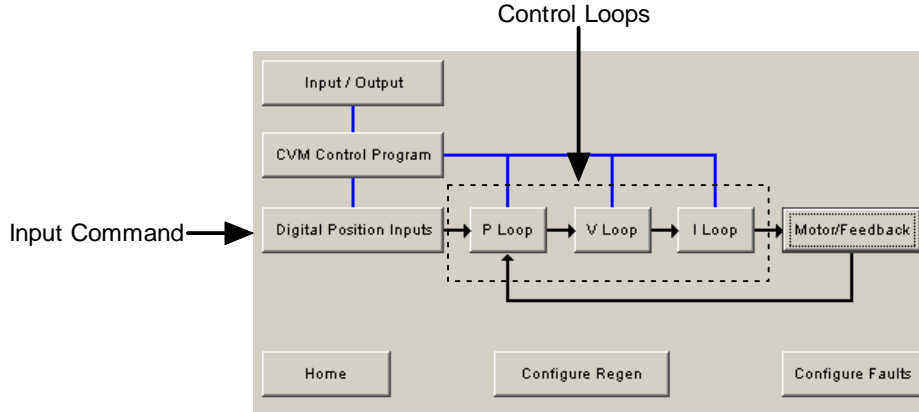

Name	Description	For More Information
Input/Output	Opens Input/Output screen.	Theory: Inputs (p. 40) and Outputs (p. 41) . Programming instructions: Amplifier Configuration (p. 93) .
CVM Control Program	Opens Copley Virtual Machine screen.	Copley Indexer Program User Guide .
Input Command	Configure the input command. Button label varies depending on the selected control loop input.	Theory: Input Command Types (p. 23) . Programming instructions: Basic Setup Screen (p. 81) .
Control Loops	Each opens a control loop configuration screen.	Theory: Operating Modes (p. 17) . Programming instructions: Current Loop (p. 116) , Velocity Loop (p. 120) , and Position Loop (p. 122) .
Motor/Feedback	Opens the Motor/Feedback screen.	Theory: Feedback (p. 16) . Programming instructions: Motor/Feedback Setup (p. 84) .
Home	Configure and test homing.	Home Function (p. 144) .
Configure Regen	Opens Regen Resistor screen.	Theory: Regen Resistor Theory (p. 42) . Programming instructions: Regen Resistor (p. 102) .
Configure Faults	Opens Fault Configuration screen.	Theory: Faults (p. 34) . Programming instructions: Non-Latched and Latched Custom Outputs (p. 100) .

6.1.5: CAN or DeviceNet Information and Status Bar

The *Main* screen displays the basic CAN or DeviceNet information. The example below shows CAN information:

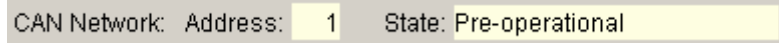

The *Address* field shows the amplifier’s present CAN or DeviceNet address. This value is updated on +24 Vdc power-up or reset only (for more information, see [CAN Addressing \[p.29\]](#)) or the *Copley DeviceNet Programmer’s Guide*. When the Position Loop Input is set to CAN, the *State* field shows the state of the amplifier’s CANopen state machine (for more information, see Copley Control’s *CANopen Programmer’s Manual*).

The status bar describes the present commutation mode, motor type, and amplifier control status as shown below. It also includes a reminder that pressing the F12 function key while CME 2 is running disables the amplifier.



6.1.6: Choosing an Amplifier from a List of Amplifiers

If, as shown on left, below, there is only one serial port set up for communications with an amplifier, CME 2 automatically attempts to connect to the amplifier on that port on CME 2 startup.

If, as shown at center, below, multiple PC serial ports have been set up for communications with multiple amplifiers, CME 2 polls all the amplifiers and displays their names in the *Copley Neighborhood*. To choose an amplifier, click on the amplifier name.

If, as shown on right, below, one amplifier serves as a CME 2 multi-drop gateway for one or more node amplifiers, the node amplifiers are indented under the gateway.

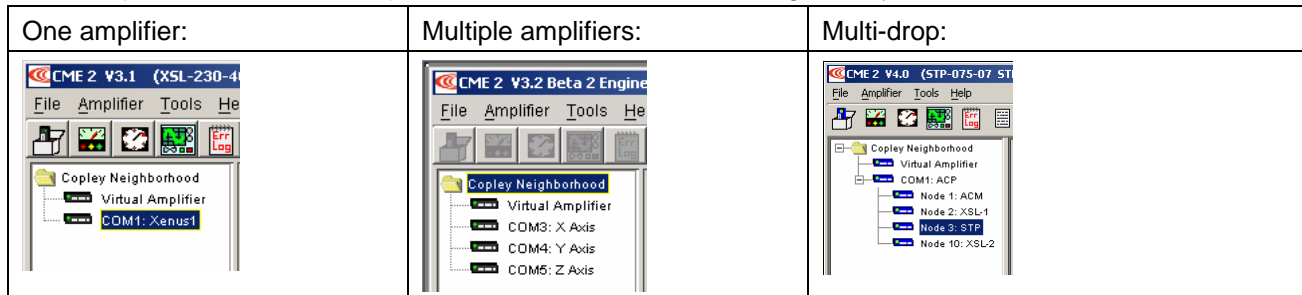

6.1.7: Renaming an Amplifier

Each amplifier represented in the *Copley Neighborhood* amplifier tree has a name. The default name for an amplifier is *unnamed*. Use this procedure to rename an amplifier.

6.1.7.1 Choose Main Menu **Amplifier**→**Rename** to open the *Rename Amplifier* screen.



6.1.7.2 Enter the new name.

6.1.7.3 Click **OK** to close the screen and save the new name or click **Cancel** to close the screen without saving the name.

6.2: Manage Amplifier and Motor Data

6.2.1: Memory

To maintain amplifier and motor settings, the amplifier uses volatile RAM memory and non-volatile flash memory. Data can also be saved to disk for backup and distribution.

Volatile and Flash Memory

Volatile memory holds status data and certain user-entered information data during operation, whereas flash memory permanently stores the data for loading into volatile memory at +24 Vdc power-up or reset, as described below.

Volatile	Flash
Contents erased when amplifier is reset or powered off.	Permanent. Contents retained when the amplifier is reset or powered off.
Initial contents read from flash on +24 Vdc power-up. Contents then updated in real time to reflect certain operational conditions and changes entered with CME 2 software. At any time, the user can use CME 2 to restore certain data from flash into volatile memory.	Modified only by using a Save to Flash tool or by closing certain screens (<i>Motor/Feedback</i> , <i>Basic Setup</i> , <i>Homing</i> , or <i>CAN Configuration</i>), whose contents are automatically saved to flash upon closing of the screen.

How the Amplifier Uses Volatile and Flash Memory

As described below, some data resides in flash only, some in volatile memory only, and some in both.

Data Resides In	Data
Flash only	This category includes all data represented on the <i>Motor/Feedback</i> screen, <i>Basic Setup</i> screen, and <i>CAN Configuration</i> screen. This data is automatically saved to flash as soon as its entry is confirmed (when the user clicks the appropriate Save to Flash button, or closes the screen).
Flash and Volatile	Includes all user-entered data represented on other screens, such as gains, limits, and I/O, faults, and regen settings. Initial values for this data are factory-set in flash. They are loaded from flash to volatile memory with each power-up or amplifier reset. This data is saved to flash only when a user clicks the appropriate Save to Flash button. It is flushed from volatile memory with each power-down or amplifier reset.
Volatile only	Includes operating status data such as actual position, actual current, and amplifier temperature. Such data is never stored in flash. It is flushed from volatile memory with each power-down or amplifier reset.

6.2.2: Disk Storage

Amplifier Data Files and Motor Data Files

At any time, the user can save certain data from volatile and flash memory to a file on disk. From the *Main* screen, the user can save all user-entered data represented on all screens (the data described as *Flash only* and *Flash and Volatile* on p. 133). This data is saved in a Copley Controls amplifier data file with a .ccx filename extension.

From the *Motor/Feedback* screen, the user can save all data represented on the *Motor/Feedback* screen. This data is saved in a Copley Controls motor data file with a .ccm filename extension.

A .ccx file can be restored to return the amplifier to a previous state or to copy settings from one amplifier to another, as described in *Quick Copy Setup Procedure* (p. 135). This procedure can be performed via a direct RS-232 serial connection or on node amplifiers via the serial connection gateway amplifier.

6.2.3: Data Management Tools

Amplifier Data Management Tools

Operations performed using the amplifier data management tools at the top of the *Main* screen (shown below) affect amplifier settings, including motor/feedback data. (CVM Control Program data is not saved by these operations.)

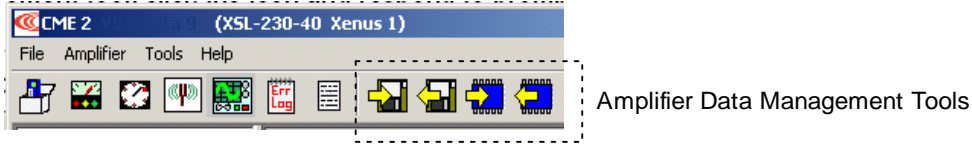

The amplifier data management tools are described below.

Icon	Name	Description
	Save amplifier data to disk	Saves all user-entered data represented on all screens from volatile and flash memory to a disk file with a .ccx filename extension.
	Restore amplifier data from disk	Restores amplifier and motor data from a .ccx file to the amplifier's volatile and flash memory. Note that only certain data is saved to flash by this operation (the data described as <i>Flash only</i> on p. 133). To assure that all data (including the data described as <i>Flash and Volatile</i>) is stored in flash, use the <i>Save amplifier data to flash</i> tool.
	Save amplifier data to flash	Saves contents of the amplifier's volatile memory to the amplifier's flash memory.
	Restore amplifier data from flash	Restores contents the amplifier's flash memory to amplifier's volatile RAM.

To use a data management tool, click the icon and respond to prompts.

Motor Data Management Tools

Operations performed using the data management tools at the bottom of the *Motor/Feedback* screen (shown below) affect only user-entered data that is represented on the *Motor/Feedback* screen.

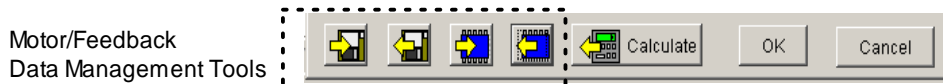

The motor data management tools are described below.

Icon	Name	Description
	Save motor data to disk	Saves only motor/feedback data from the PC to a disk file with a .cm filename extension. Amplifier data that is not represented on the <i>Motor/Feedback</i> screen is not saved in this file, and this operation does not affect any .ccx files.
	Restore motor data from disk	Restores only motor data from a disk file with a .cm filename extension to the PC. Amplifier data that is not represented on the <i>Motor/Feedback</i> screen is not affected.
	Save motor data to flash	Saves the contents of the <i>Motor/Feedback</i> screen from PC to the amplifier's flash memory. Amplifier data that is not represented on the <i>Motor/Feedback</i> screen is not saved. Can be used to assure that all changes are saved to flash without closing the <i>Motor/Feedback</i> screen.
	Restore motor data from flash	Restores only motor data from the amplifier's flash memory to the PC. Amplifier data that is not represented on the <i>Motor/Feedback</i> screen is not affected. Can be used before closing the <i>Motor/Data</i> screen to restore settings to the previously saved values.

To use a data management tool, click the icon and respond to prompts.

6.2.4: Quick Copy Setup Procedure

Use this procedure to configure an amplifier/motor pair by copying a .ccx file that was prepared for the amplifier/motor combination.

- 6.2.4.1 Make sure the amplifier is connected to the PC using the J5 RS-232 connector.
For wiring instructions, see [RS-232 Serial Communications \(J5\)](#) (p. 61).



- 6.2.4.2 Start CME 2 by double-clicking the CME 2 desktop shortcut icon:

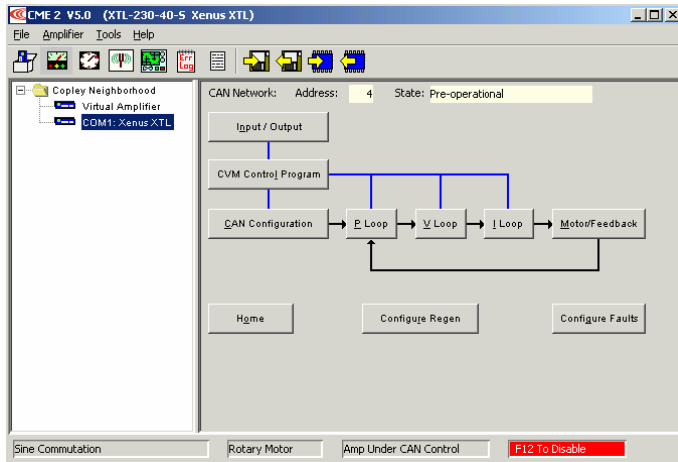

- 6.2.4.3 On the *Main* screen, click **Restore amplifier data from disk**.
- 6.2.4.4 When prompted, navigate to the folder containing the appropriate .ccx file. Highlight the file name and then click **Open** to load the file data into volatile memory.
- 6.2.4.5 On the *Main* screen, click **Save to Flash** to save the new settings to flash memory.
- 6.2.4.6 If you do not need to load a CVM Control Program, skip to Step 6.2.4.7. To load a CVM Control Program, choose **File→Restore CVM Control Program**. When prompted, navigate to the folder containing the appropriate .ccp file. Highlight the file name and then click **Open** to load the file data into flash memory. This procedure also results in the setting of the Indexer 2 Program option Enable Control Program on Startup. This configures the program to auto start when the amplifier is powered up or reset.
- 6.2.4.7 If you do not need to load a set of Cam Tables, the process is complete. To load a set of Cam Tables, choose **File→Restore Cam Tables**. When prompted, navigate to the folder containing the appropriate .cct file. Highlight the file name and then click **Open** to load the file data into flash memory.

TIP: When copying amplifier data to multiple amplifiers in a production environment, consider locking CME 2 to prevent accidental changes to settings. For more information on locking/unlocking CME 2, see the *CME 2 User's Guide*.

6.3: Downloading Firmware

6.3.1: Acquiring Firmware from Web Site (Optional)

- 6.3.1.1 In an internet browser, navigate to:
<http://www.copleycontrols.com/Motion/Downloads/firmware.html>
- 6.3.1.2 Under click on the appropriate firmware name.
- 6.3.1.3 When prompted, save the file to the *Firmware Image* folder in the CME 2 installation folder.
(The default installation folder is
C:\Program Files\Copley Motion\CME 2\FirmwareImage.)
The folder should now contain a file named *Xenus_Firmware.zip*.
- 6.3.1.4 Extract the contents of the zip file to the same location.
The folder should now contain the files *Xenus_Firmware.zip* and the latest *.cff* file.
- 6.3.1.5 If desired, delete *Xenus_Firmware.zip* to save disk space.

6.3.2: Downloading Firmware to Amplifier

NOTE: Firmware can only be downloaded to an amplifier via a direct serial port connection between the amplifier and the PC. CME 2 does not support downloading firmware to a node amplifier via a multi-drop gateway amplifier.

- 6.3.2.1 On the *Main* screen choose **Tools**→**Download Firmware** to open the *Download Firmware* window.

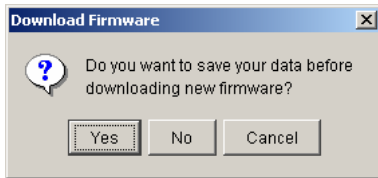

- 6.3.2.2 To download new firmware without saving amplifier and motor data, click **No** and then proceed to Step 6.3.2.4.

- 6.3.2.3 To save amplifier and motor data for backup purposes before downloading firmware, click **Yes**.

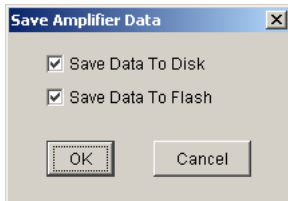

- 1 Use check marks to select whether to save to disk, flash, both, or neither.
- 2 Click **OK** to save data and continue to select a firmware image, or click **Cancel** to continue without saving data.
- 3 If *Save Data to Disk* was checked, use the *Save Amplifier Data to Disk* screen to browse to the folder where you want to save the .ccx file. Then enter a name in the *Name* field. Then click **Save**.
When the *Firmware Images* window appears, proceed to Step 6.3.2.4.

- 6.3.2.4 Use the *Firmware Images* window to locate and select a firmware image file.

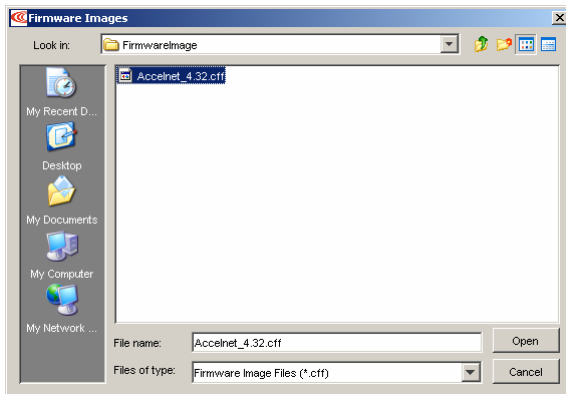

- 6.3.2.5 Click **Open** to begin the download.
(Or click **Cancel** to close the screen without downloading new firmware.)
A message window displays a series of progress messages:

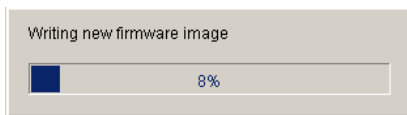

When the message window closes, the firmware download is complete.

6.4: Control Panel

6.4.1: Control Panel Overview

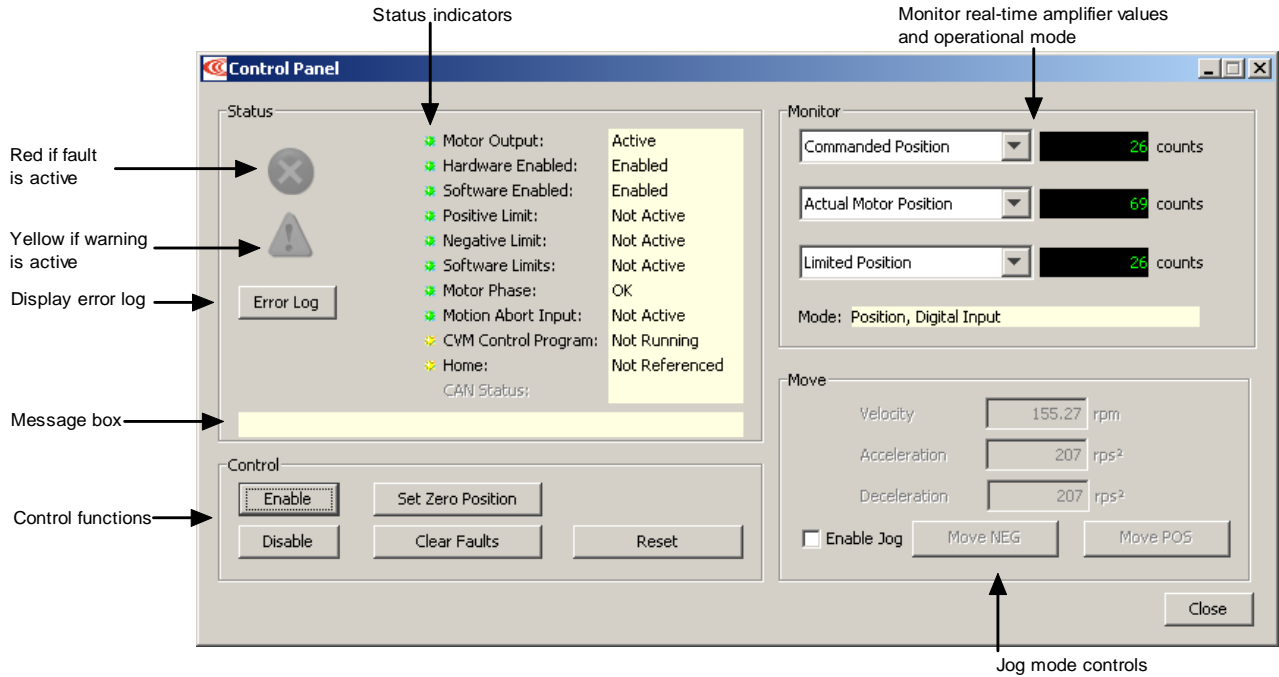

To access the control panel, click the **Control Panel** icon () on the *Main* screen. Each of the features labeled below is described in the following sections.



6.4.2: Status Indicators and Messages

The *Status* area includes status indicator lights (described below) and a message box. All green lights indicate the amplifier is enabled and ready to accept motion commands.

Indicator	States/Description
Motor Output	State of the PWM output stage. Red if the output stage is inactive (disabled)
Hardware Enabled	State of the hardware enable input(s). Red if one or more enable inputs are inactive.
Software Enabled	State of the software enable. Red if the amplifier is disabled by software.
Positive Limit	State of the positive limit switch input. Red indicates an activated positive limit switch.
Negative Limit	State of the negative limit switch input. Red indicates an activated negative limit switch.
Software Limits	State of the software limits. Red indicates an activated software limit.
Motor Phase	Indicates a motor phasing error. Red indicates a motor phasing error exists.
Motion Abort Input	State of the programmed Motion Abort Input. Red indicates the input is active.
CVM Control Program	Status of the CVM Control Program.
Home	Indicates whether the axis has successfully been referenced (homed).
CAN Status	The status of the CAN Bus. Yellow indicates a CAN warning limit reached. Red indicates a bus error detected. (If the CAN Status indicator is replaced by the DeviceNet Status indicator, see the <i>Copley DeviceNet Programmer's Guide</i> .)
<i>Continued...</i>	

<i>...continued:</i>	
Indicator	States/Description
	The fault indicator goes red when a fault is active. Check the status message box for a description of the most recent fault: <code>Fault: Under Voltage</code> . Check the Error Log for a full history of faults and warnings.
	The warning indicator goes yellow when a warning is active. Check the status message box for a description of the most recent: <code>Warning: Pos Outside of Tracking Window</code> . Check the Error Log for a full history of faults and warnings.
Message Box	Displays status descriptions.

The message box below the indicators displays the most recent active fault or warning message.

6.4.3: Control Panel Monitor Channels

The Control Panel Monitor channels can display real-time values on up to three separate variables.

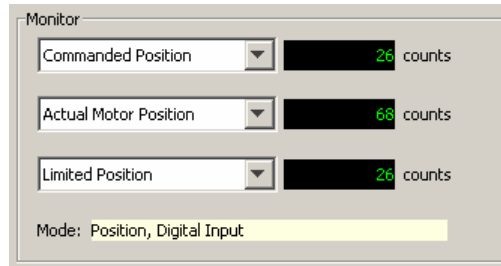

To set up a monitor display box, click in the list box and select a variable from the list.

Disabled disables the display. Other options represent the following amplifier values:

- Actual Current
- Actual Motor Velocity
- Actual Motor Position
- Actual Load Velocity
- Actual Load Position
- Velocity Error
- Following Error
- Commanded Current
- Commanded Velocity
- Commanded Position
- Profile Velocity
- Profile Acceleration
- Passive Load Position
- Limited Position
- Analog Command
- Bus Voltage
- Amplifier Temperature
- Motor Phase Angle

Mode: Displays the amplifier's present operating mode. In camming it also displays the active cam table number.

6.4.4: Control Functions

The *Control* area of the screen, shown here, provides functions related to overall amplifier control. The screen options are different when the *Position Loop Input* is **CAN**.

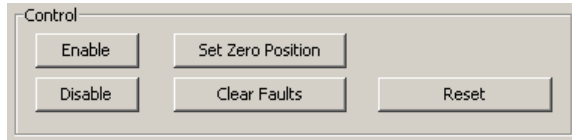

Control the operational state of the amplifier using the buttons described below.

Control	Description
Enable	Click to software enable the amplifier.
Disable	Click to software disable the amplifier.
Set Zero Position	Click to set the amplifier's actual position counter to zero.
Clear Faults	Click to clear all amplifier faults.
Reset	Click to reset the amplifier.



WARNING

Risk of unexpected or uncontrolled motion.

Using the CME 2 *Set Zero Position* function while the amplifier is operating under CANopen control could cause unexpected or uncontrolled motion.

Failure to heed this warning can cause equipment damage.

6.4.5: Jog Mode

Jog mode provides a simple way to generate forward or reverse commands as described here:

6.4.5.1 To put the amplifier in jog mode, set the **Enable Jog** option.

6.4.5.2 Set up a jog move by setting the following mode-specific parameters:

Mode	Parameter	Description
Current	Current	Current applied to the motor. Limited by current loop <i>Continuous Current</i> . Warning: Unloaded motors may, depending on torque setting, ramp up in speed very quickly.
	Current Ramp	The rate at which the current will increase and decrease.
Velocity	Jog Speed	Velocity of the jog move. Limited by velocity loop <i>Vel. Limit</i> .
Position	Velocity	Velocity of the jog move. Limited by velocity loop <i>Vel. Limit</i> .
	Acceleration	Acceleration limit of the jog move.
	Deceleration	Deceleration limit of the jog move.

6.4.5.3 Command the move.

Mode	Steps
Current	<ul style="list-style-type: none"> Hold Pos to apply positive current to the motor or hold down Neg to apply negative current to the motor. Release the button to command zero current.
Velocity	<ul style="list-style-type: none"> Hold Jog Pos to command a forward velocity or hold down Jog Neg to command a negative velocity. Release the button to command zero velocity.
Position	<ul style="list-style-type: none"> Hold Move Pos to generate a forward move profile or hold Move Neg to generate a negative move profile. Release the button to stop movement. <p>NOTE: A position mode jog move continuously updates the commanded position. If a following error develops with Following Error Fault is disabled, motion will not stop on button release. Instead, it stops when actual position = commanded position.</p>

6.5: Manual Phasing

6.5.1: Manual Phase Objectives

The CME 2 Manual Phase tool lets the user phase a brushless motor, monitor signals, check configuration wiring, and control a microstepping current vector.

6.5.2: Manual Phase Instructions, Quad A/B Encoder XTL Xenus

- 6.5.2.1 Make sure that no load is connected to the motor.
- 6.5.2.2 On the *Main* screen, choose **Tools**→**Manual Phase** to open *Manual Phase*.

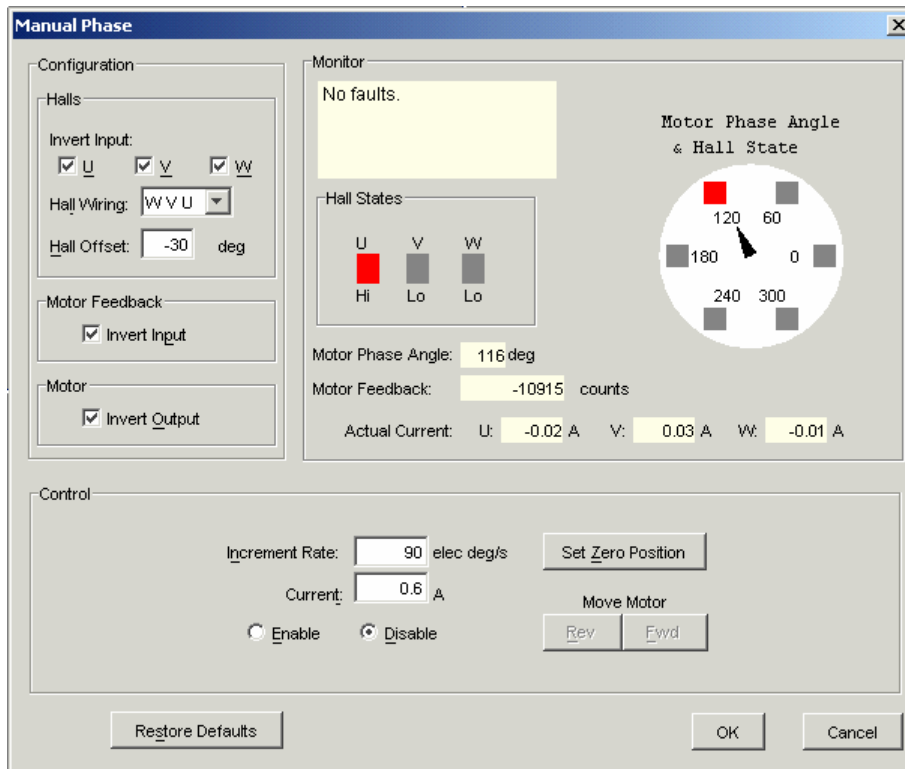

6.5.2.3

Verify the **Current** setting and then enable the amp by selecting **Enable** in the Control area of the Manual Phase window.

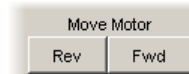

To control the current vector rotation, command the motor forward or reverse.
NOTE: Some motors have bearings stiction, so helping the motor with mechanical force is acceptable. Motors with no friction may need friction added to steady motion.

- 6.5.2.4 If the motor cannot keep up with the rate of vector rotation, then reduce the *Increment Rate* or increase the *Current*.
- 6.5.2.5 Verify that pressing forward button moves motor forward. If it does not, toggle the Motor Invert Output box setting.
- 6.5.2.6 Verify actual position count agrees with direction of rotation: increasing counts in forward direction and decreasing counts in reverse direction. If it does not, toggle the Encoder Invert Input box setting.

6.5.2.7 Monitor the vector rotation through one electrical cycle for proper Hall transitions.

- 1 Verify that the red indicator rotates in the same direction as the motor phase angle, and that the transition occurs when the needle is between indicators (± 30 degrees, as shown below).

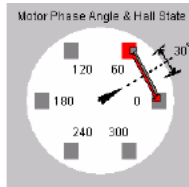

- 2 If the needle and Hall states do not track properly, use the *Hall Wiring* list box (shown below) to swap the amplifier’s Hall wire configuration.

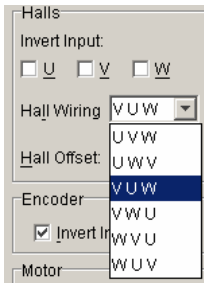

- 3 If the red indicator transition leads or lags behind the centered needle by more than 30 degrees, then try adjusting the *Hall Offset* in +/- 30 degree increments:



6.5.2.8 Phasing of a motor with encoder and Halls is complete. Click **OK**.

6.6: Home Function

6.6.1: Overview

The CME 2 Home function can be used to set and test homing parameters.

6.6.2: Homing Functions Settings

6.6.2.1 On *Main* screen, click **Home** to open the *Homing* screen.

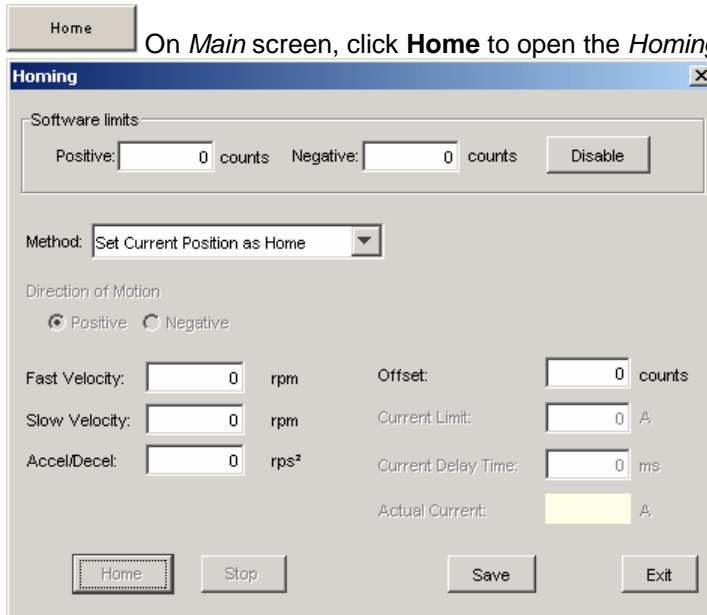

6.6.2.2 Select homing options described below.

Parameter	Description
Software limits: Positive	Position of user-defined travel limits that take effect after homing operation.
Software limits: Negative	
Software limits: Disable	Disables the use of software limits by setting both limits to zero.
Method	Homing method. See <i>Homing Methods</i> in the <i>CME 2 User Guide</i> .
Direction of Motion	Initial direction of motion for the homing method (Pos or Neg).
Fast Velocity	The velocity used to find a limit or home switch. Also used when moving to an offset position, or a resolver or Servo Tube index position.
Slow Velocity	The velocity used to find a switch edge, incremental or analog encoder index pulse, or hard stop.
Accel/Decel	The acceleration and deceleration rate used during homing.
Offset	Execute a move of this distance after the reference is found. Set actual position to 0 and call the new position home.
Current Limit	Hard stop home is reached when the amplifier outputs the homing Current Limit continuously for the time specified in the Delay Time.
Current Delay Time	
Actual Current	Shows actual current being applied to windings during homing.

6.6.2.3 Optionally click **Home** to begin a homing sequence.

6.6.2.4 To stop the homing sequence before it is completed, click **Stop**.

6.6.2.5 Click **Save** to save the settings to flash memory. Click **Exit** to close the screen.

APPENDIX

A: REGEN RESISTOR SIZING AND CONFIGURATION

This chapter describes the formulas used to determine if a regen resistor is required and what the optimal resistor characteristics would be for a given application. For an overview of regeneration and regen resistors, see [Regen Resistor Theory \(p. 42\)](#).

The contents of this chapter include:

Title	Page
A.1: Sizing a Regen Resistor.....	146
A.2: Configuring a Custom Regen Resistor	150

A.1: Sizing a Regen Resistor

A.1.1: Gather Required Information

Calculating the power and resistance of the regen resistor requires information about the amplifier and the rotary or linear motor application.

- A.1.1.1 For all applications, gather the following information:
- 1 Details of the complete motion profile, including times and velocities
 - 2 Amplifier model number
 - 3 Applied line voltage to the amplifier
 - 4 Torque constant of the motor
 - 5 Resistance (line-to-line) of the motor windings.
- A.1.1.2 For rotary motor applications, gather this additional information:
- 1 Load inertia seen by the motor
 - 2 Inertia of the motor.
- A.1.1.3 For linear motor applications, gather this additional information:
- 1 Mass of the moving load
 - 2 Mass of the motor forcer block if the motor rod is stationary
OR
Mass of the motor rod if the motor forcer block is stationary.

A.1.2: Observe the Properties of Each Deceleration During a Complete Cycle of Operation

- A.1.2.1 For each deceleration during the motion cycle, determine:
- 1 Speed at the start of the deceleration
 - 2 Speed at the end of the deceleration
 - 3 Time over which the deceleration takes place.

A.1.3: Calculate Energy Returned for Each Deceleration

Use the following formulas to calculate the energy returned during each deceleration:

Rotary motor:

$$E_{\text{dec}} = \frac{1}{2} J_t (\omega_1^2 - \omega_2^2)$$

Where:

E_{dec} = Energy returned by the deceleration, in joules.

J_t = Load inertia on the motor shaft plus the motor inertia in kg m^2 .

ω_1 = Shaft speed at the start of deceleration in radians per second.

ω_2 = Shaft speed at the end of deceleration in radians per second.

ω = 2π RPS.

Linear motor:

$$E_{\text{dec}} = \frac{1}{2} M_t (V_1^2 - V_2^2)$$

Where:

E_{dec} = Energy returned by the deceleration, in joules.

M_t = Total mass of the load and the moving part of the motor in kg.

V_1 = Velocity at the start of deceleration in meters per second.

V_2 = Velocity at the end of deceleration in meters per second.

A.1.4: Determine the Amount of Energy Dissipated by the Motor

Calculate the amount of energy dissipated by the motor due to current flow through the motor winding resistance using the following formulas.

$$P_{\text{motor}} = \frac{3}{4} R_{\text{winding}} (F / Kt)^2$$

Where:

P_{motor} = Power dissipated in the motor in watts.

R_{winding} = Line to line resistance of the motor.

F = Force needed to decelerate the motor:

Nm for rotary applications

N for linear applications

Kt = Torque constant for the motor:

Nm/Amp for rotary applications

N/Amp for linear applications

$$E_{\text{motor}} = P_{\text{motor}} T_{\text{decel}}$$

Where:

E_{motor} = Energy dissipated in the motor in joules

T_{decel} = Time of deceleration in seconds

A.1.5: Determine the Amount of Energy Returned to the Amplifier

Calculate the amount of energy that will be returned to the amplifier for each deceleration using the following formula.

$$E_{\text{returned}} = E_{\text{dec}} - E_{\text{motor}}$$

Where:

E_{returned} = Energy returned to the amplifier, in joules

E_{dec} = Energy returned by the deceleration, in joules

E_{motor} = Energy dissipated by the motor, in joules

A.1.6: Determine if Energy Returned Exceeds Amplifier Capacity

Compare the amount of energy returned to the amplifier in each deceleration with the amplifier's energy absorption capacity. For related amplifier specifications, see [Regen Circuit Output \(p. 45\)](#).

For mains voltages not listed in the specification table, use the following formula to determine the energy that can be absorbed by the amplifier.

$$W_{\text{capacity}} = \frac{1}{2} C (V_{\text{regen}}^2 - (1.414 V_{\text{mains}})^2)$$

Where:

W_{capacity} = The energy that can be absorbed by the bus capacitors, in joules.

C = Bus capacitance in farads.

V_{regen} = Voltage at which the regen circuit turns on, in volts.

V_{mains} = Mains voltage applied to the amplifier, in volts AC.

A.1.7: Calculate Energy to be Dissipated for Each Deceleration

For each deceleration where the energy exceeds the amplifier's capacity, use the following formula to calculate the energy that must be dissipated by the regen resistor:

$$E_{\text{regen}} = E_{\text{returned}} - E_{\text{amp}}$$

Where:

E_{regen} = Energy that must be dissipated in the regen resistor, in joules.

E_{returned} = Energy delivered back to the amplifier from the motor, in joules.

E_{amp} = Energy that the amplifier will absorb, in joules.

A.1.8: Calculate Pulse Power of Each Deceleration that Exceeds Amplifier Capacity

For each deceleration where energy must be dissipated by the regen resistor, use the following formula to calculate the pulse power that will be dissipated by the regen resistor:

$$P_{\text{pulse}} = E_{\text{regen}} / T_{\text{decel}}$$

Where:

P_{pulse} = Pulse power in watts.

E_{regen} = Energy that must be dissipated in the regen resistor, in joules.

T_{decel} = Time of the deceleration in seconds.

A.1.9: Calculate Resistance Needed to Dissipate the Pulse Power

Using the maximum pulse power from the previous calculation, calculate the resistance value of the regen resistor required to dissipate the maximum pulse power: For related amplifier specifications, see [Regen Circuit Output \(p. 45\)](#).

$$R = V_{\text{regen}}^2 / P_{\text{pulse max}}$$

Where:

R = Resistance in ohms.

$P_{\text{pulse max}}$ = The maximum pulse power.

V_{regen} = The voltage at which the regen circuit turns on.

Choose a standard value of resistance less than the calculated value. This value must be greater than the minimum regen resistor value specified in [Regen Circuit Output \(p. 45\)](#).

A.1.10: Calculate Continuous Power to be Dissipated

Use the following formula to calculate the continuous power that must be dissipated by the regen resistor. Use each deceleration where energy is dissipated by the regen resistor.

$$P_{\text{cont}} = (E_{\text{regen 1}} + E_{\text{regen 2}} + E_{\text{regen ...}}) / T_{\text{cycle}}$$

Where:

P_{cont} = The continuous power that will be dissipated by the resistor in watts.

$E_{\text{regen n}}$ = Energy being dissipated during decelerations, in joules.

T_{cycle} = Total cycle time in seconds.

Choose a resistor with a power rating equal to or greater than the calculated continuous power. Verify that the calculated power value is less than the continuous regen power rating specified in [Regen Circuit Output \(p. 45\)](#).

A.1.11: Select Fuses

For custom regen resistors, Cooper Bussman KLM fuses, or equivalent, should be selected. The peak and continuous currents, as well as the peak current time, must be taken into consideration for proper fuse selection. The duration of the peak current is the deceleration time (T_{decel}) associated with the maximum pulse power regen event.

Use the following formulas to determine the minimum peak and continuous current ratings of the fuse. For related amplifier specifications, see [Regen Circuit Output \(p. 45\)](#).

The peak current is determined by the chosen regen resistor value.

$$I_{\text{peak}} = V_{\text{regen}} / R_{\text{regen}}$$

Where:

I_{peak} = The current through the regen resistor during regeneration in amps.

V_{regen} = The voltage at which the regen circuit turns on.

R_{regen} = The resistance value of the chosen regen resistor in ohms.

The continuous current is determined by the continuous regen power.

$$I_{\text{cont}} = P_{\text{cont}} / V_{\text{regen}}$$

Where:

I_{cont} = The minimum continuous current rating the fuse requires in amps.

P_{cont} = The continuous power calculated in the previous step, in watts.

V_{regen} = The voltage at which the regen circuit turns on.

A.2: Configuring a Custom Regen Resistor

A.2.1: Regen Configuration Objective and Warning

Configure the amplifier to operate properly with the custom resistor.



WARNING

Incorrect values may damage amplifier or external regen resistor.

For the regen I^2T algorithms to work correctly, the values entered in the following steps must be correct. Damage to the external regen resistor may result from incorrect values entered. Damage to the amplifier may result if an incorrect resistance value is entered.

Failure to heed this warning can cause equipment damage.

A.2.2: Regen Configuration Instructions

A.2.2.1



Click **Configure Regen** to open the *Regen Resistor* screen.

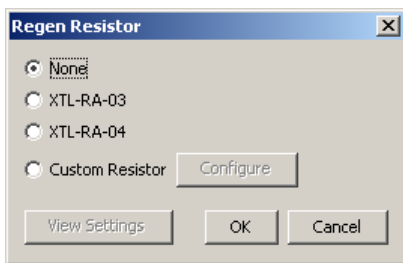

A.2.2.2

If configuring a standard Copley Controls regen resistor, select the model number and click **Finish** to save the configuration and close the screen. Otherwise, continue Select *Custom Resistor* and then click **Configure** to open the *Custom Regen Configuration* screen.

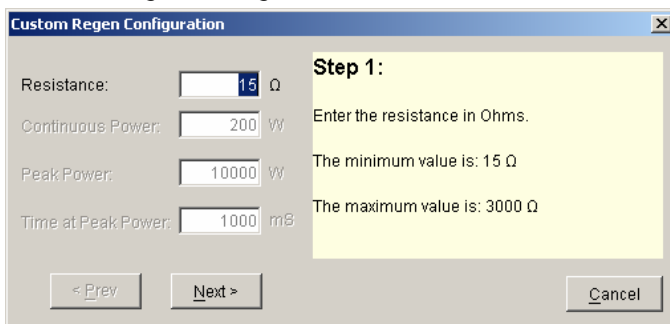

A.2.2.3

Enter a **Resistance** within the range described on the screen. Click **Next** for Step 2.

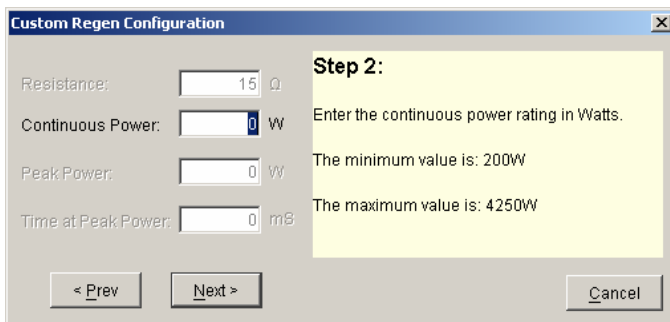

A.2.2.4 Enter a **Continuous Power** within the range described. Click **Next** for Step 3.

The screenshot shows the 'Custom Regen Configuration' dialog box at Step 3. On the left, there are four input fields: Resistance (15 Ω), Continuous Power (200 W), Peak Power (450 W), and Time at Peak Power (0 mS). The 'Continuous Power' field is highlighted. On the right, a yellow box contains the text: 'Step 3: Enter the peak power rating in Watts. The minimum value is: 200W. The maximum value is: 10000W'. At the bottom, there are three buttons: '< Prev', 'Next >', and 'Cancel'.

A.2.2.5 Enter a **Peak Power** within the range described. Click **Next** for Step 4.

The screenshot shows the 'Custom Regen Configuration' dialog box at Step 4. On the left, there are four input fields: Resistance (15 Ω), Continuous Power (200 W), Peak Power (450 W), and Time at Peak Power (50 mS). The 'Peak Power' field is highlighted. On the right, a yellow box contains the text: 'Step 4: Enter the peak power duration in milliseconds. The minimum value is: 50 mS. The maximum value is: 5000 mS'. At the bottom, there are three buttons: '< Prev', 'Next >', and 'Cancel'.

A.2.2.6 Click **Next** for Step 5.

The screenshot shows the 'Custom Regen Configuration' dialog box at Step 5. On the left, there are four input fields: Resistance (15 Ω), Continuous Power (200 W), Peak Power (450 W), and Time at Peak Power (50 mS). The 'Time at Peak Power' field is highlighted. On the right, a yellow box contains the text: 'Step 5: Custom regen configuration is complete! Press Finish to accept the values entered and save them to the amplifier's RAM and flash. To change any of the values press Prev'. At the bottom, there are three buttons: '< Prev', 'Finish', and 'Cancel'.

A.2.2.7 Review the configuration.

A.2.2.8 Click **Finish** to save the configuration to volatile and flash memory and close the screen.

This page for notes.

APPENDIX

B: I²T TIME LIMIT ALGORITHM

The current loop I²T limit specifies the maximum amount of time that the peak current can be applied to the motor before it must be reduced to the continuous limit or generate a fault. This chapter describes the algorithm used to implement the I²T limit.

B.1: I²T Algorithm

B.1.1: I²T Overview

The I²T current limit algorithm continuously monitors the energy being delivered to the motor using the I²T Accumulator Variable. The value stored in the I²T Accumulator Variable is compared with the I²T setpoint that is calculated from the user-entered Peak Current Limit, I²T Time Limit, and Continuous Current Limit. Whenever the energy delivered to the motor exceeds the I²T setpoint, the algorithm protects the motor by limiting the output current or generates a fault.

B.1.2: I²T Formulas and Algorithm Operation

Calculating the I²T Setpoint Value

The I²T setpoint value has units of Amperes²-seconds (A²S) and is calculated from programmed motor data. The setpoint is calculated from the Peak Current Limit, the I²T Time Limit, and the Continuous Current Limit as follows:

$$\text{I}^2\text{T setpoint} = (\text{Peak Current Limit}^2 - \text{Continuous Current Limit}^2) * \text{I}^2\text{T Time Limit}$$

I²T Algorithm Operation

During amplifier operation, the I²T algorithm periodically updates the I²T Accumulator Variable at a rate related to the output current Sampling Frequency. The value of the I²T Accumulator Variable is incrementally increased for output currents greater than the Continuous Current Limit and is incrementally decreased for output currents less than the Continuous Current Limit. The I²T Accumulator Variable is not allowed to have a value less than zero and is initialized to zero upon reset or +24 Vdc logic supply power-cycle.

Accumulator Increment Formula

At each update, a new value for the I²T Accumulator Variable is calculated as follows:

$$\begin{aligned} \text{I}^2\text{T Accumulator Variable}_{n+1} = & \\ \text{I}^2\text{T Accumulator Variable}_n & \\ +(\text{Actual Output Current}_{n+1}^2 - \text{Continuous Current Limit}^2) * \text{Update period} & \end{aligned}$$

After each sample, the updated value of the I²T Accumulator Variable is compared with the I²T setpoint. If the I²T Accumulator Variable value is greater than the I²T Setpoint value, then the amplifier limits the output current to the Continuous Current Limit. When current limiting is active, the output current will be equal to the Continuous Current Limit if the commanded current is greater than the Continuous Current Limit. If instead the commanded current is less than or equal to the Continuous Current Limit, the output current will be equal to the commanded current.

B.1.3: I²T Current Limit Algorithm – Application Example

I²T Example: Parameters

Operation of the I²T current limit algorithm is best understood through an example. For this example, a motor with the following characteristics is used:

- Peak Current Limit – 12 A
- I²T Time Limit – 1 S
- Continuous Current Limit – 6 A

From this information, the I²T setpoint is:

$$I^2T \text{ setpoint} = (12 \text{ A}^2 - 6 \text{ A}^2) * 1 \text{ S} = 108 \text{ A}^2\text{S}$$

See the example plot diagrams on the next page.

I²T Example: Plot Diagrams

The plots that follow show the response of an amplifier (configured w/ I²T setpoint = 108 A²S) to a given current command. For this example, DC output currents are shown in order to simplify the waveforms. The algorithm essentially calculates the RMS value of the output current, and thus operates the same way regardless of the output current frequency and wave shape.

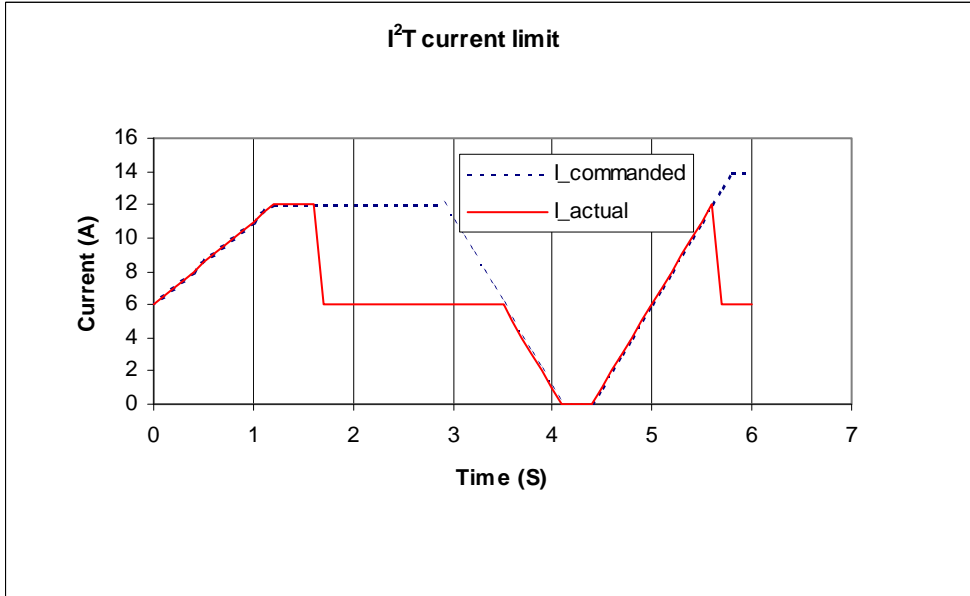

A)

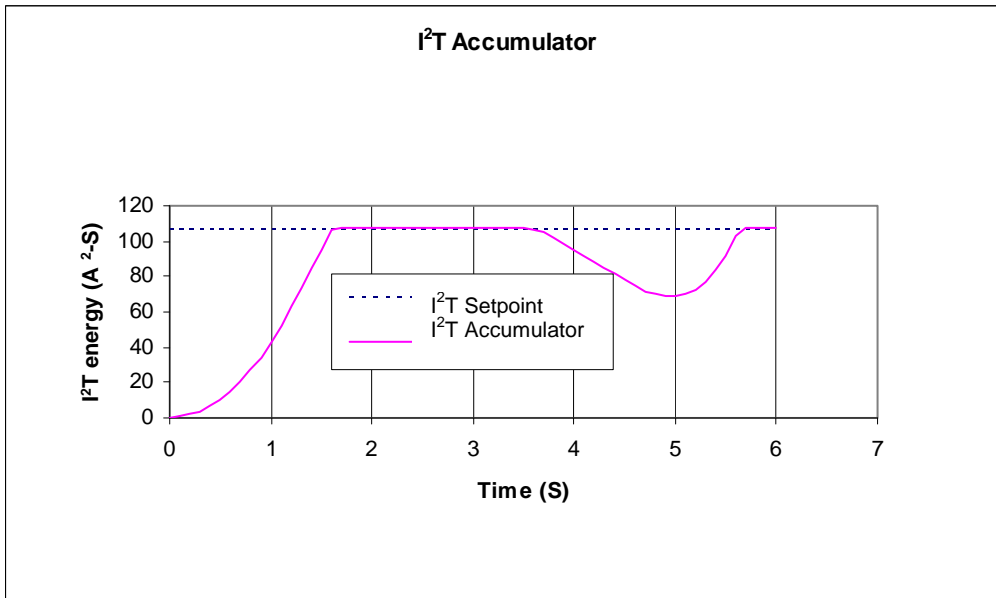

B)

At time 0, plot diagram A shows that the actual output current follows the commanded current. Note that the current is higher than the continuous current limit setting of 6 A. Under this condition, the I²T Accumulator Variable begins increasing from its initial value of zero. Initially, the output current linearly increases from 6 A up to 12 A over the course of 1.2 seconds. During this same period, the I²T Accumulator Variable increases in a non-linear fashion because of its dependence on the square of the current.

At about 1.6 seconds, the I²T Accumulator Variable reaches a values equal to the I²T setpoint. At this time, the amplifier limits the output current to the continuous current limit even though the commanded current remains at 12 A. The I²T Accumulator Variable value remains constant during

the next 2 seconds since the difference between the actual output current and the continuous current limit is zero.

At approximately 3.5 seconds, the commanded current falls below the continuous current limit and once again the output current follows the commanded current. Because the actual current is less than the continuous current, the I²T Accumulator Variable value begins to fall incrementally.

The I²T Accumulator Variable value continues to fall until at approximately 5.0 seconds when the commanded current goes above the continuous current limit again. The actual output current follows the current command until the I²T Accumulator Variable value reaches the I²T setpoint and current limiting is invoked.

APPENDIX

C: THERMAL CONSIDERATIONS

This chapter describes operating temperature characteristics, heatsink options, and heatsink mounting instructions. Contents include:

C.1: Operating Temperature and Cooling Configurations	160
C.1.2: Heatsink and Fan Configurations	161
C.2: Heatsink Mounting Instructions	162

C.1: Operating Temperature and Cooling Configurations

The following charts show the maximum allowable ambient temperature of Xenus amplifiers for a variety of operating conditions and cooling configurations. The cooling options are for Xenus amplifiers with no heatsink, with the low profile heatsink and with the standard heatsink all with and without forced-air cooling. The operating conditions considered cover a range of continuous output currents at both 120 Vac and 240 Vac mains voltages.

Model XTL-230-18 (-R, -S) Mains 120 Vac

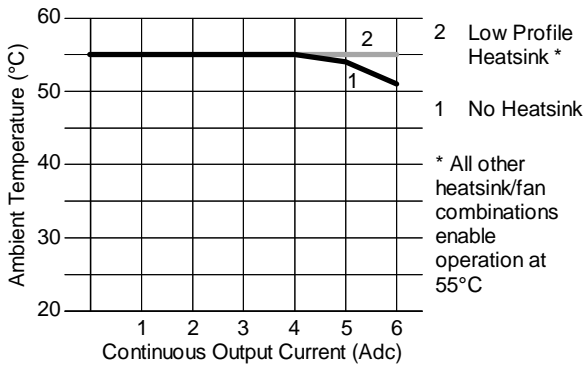

Mains 240 Vac

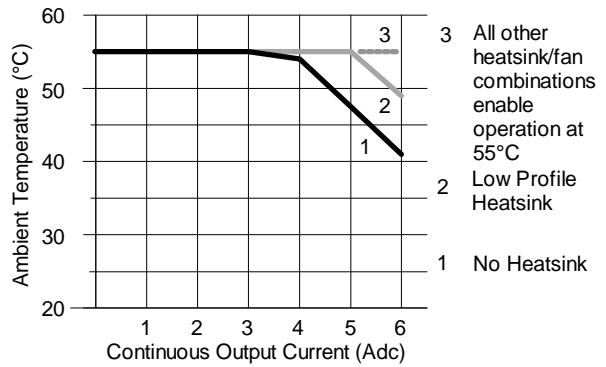

Model XTL-230-36 (-R, -S) Mains 120 Vac

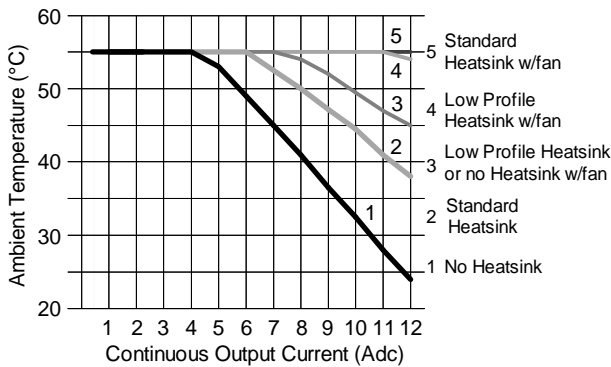

Mains 240 Vac

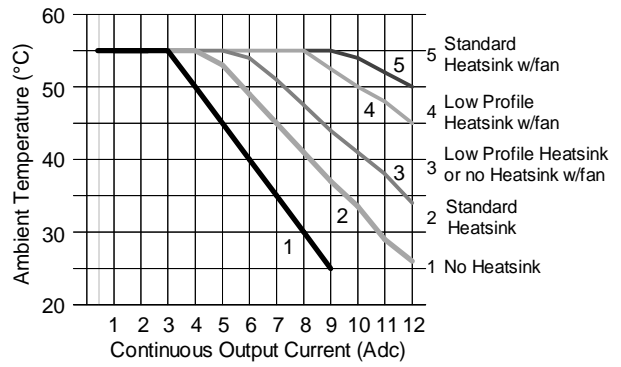

Model XTL-230-40 (-R, -S) Mains 120 Vac

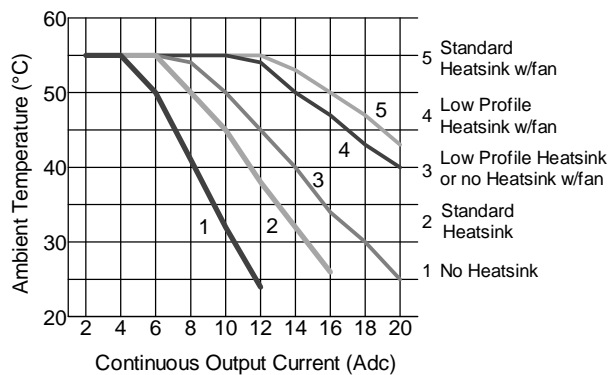

Mains 240 Vac

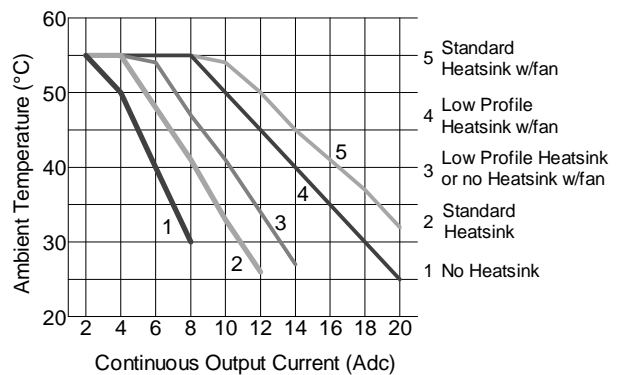

The various cooling configurations are shown on the following page.

C.1.2: Heatsink and Fan Configurations

No Heatsink

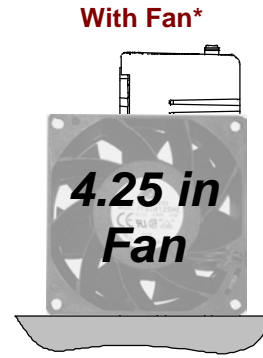
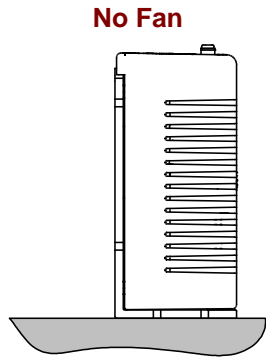

Low-Profile Heatsink

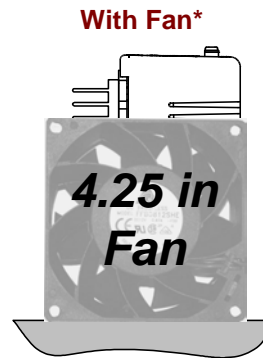
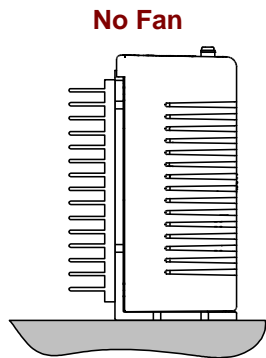

Standard Heatsink

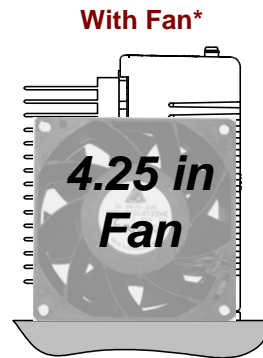
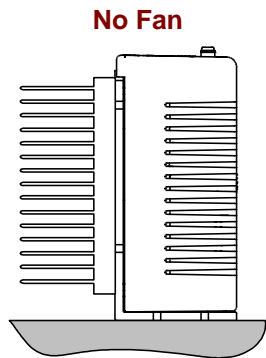

* Select a 4.25-inch square fan that supplies forced air at a minimum rate of 300 linear feet per minute

C.2: Heatsink Mounting Instructions

A dry film interface pad is used in place of thermal grease. The pad is die-cut to shape and has holes for the heat sink mounting screws. There are two protective sheets, blue on one side and clear on the other. Both must be removed when the interface pad is installed.

C.2.1 Remove the blue protective sheet from one side of the pad.

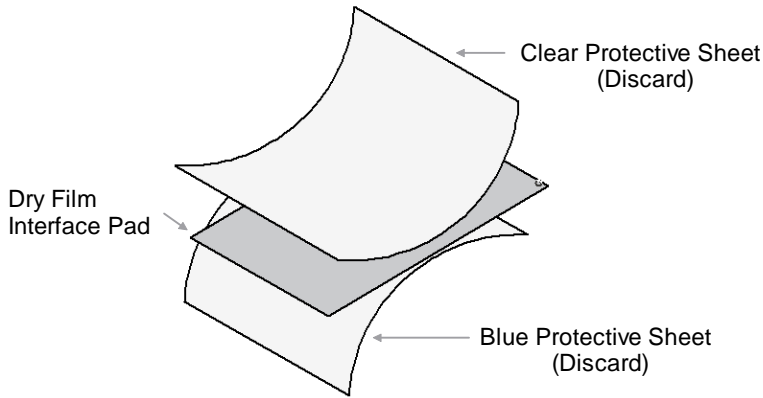

C.2.2 Place the interface pad on the amplifier, taking care to center the pad holes over the heatsink mounting holes.

C.2.3 Remove the clear protective sheet from the pad.

C.2.4 Mount the heatsink onto the amplifier taking care to see that the holes in the heatsink, interface pad, and amplifier all line up.

C.2.4 Torque the #6-32 mounting screws to 8~10 lb-in (0.9~1.13 Nm).

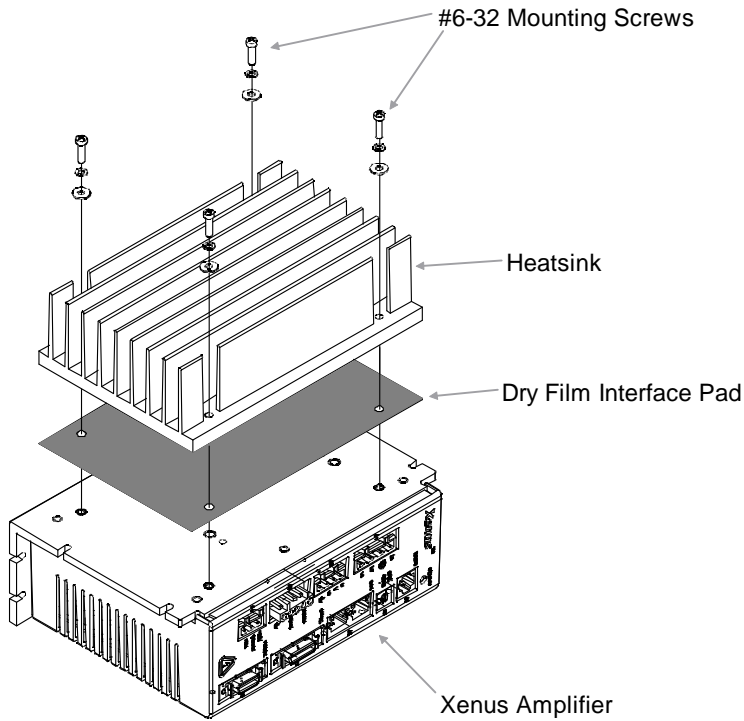

NOTE: The drawing shows the standard heatsink kit (XTL-HS), but the mounting instructions given are valid for the low profile heatsink kit (XTL-HL) as well.

APPENDIX

D: XENUS FILTER

This chapter provides an overview of the Model XTL-FA-01 edge filter.

The contents of this chapter include:

Title	Page
D.1: Overview.....	164
D.2: XTL-FA-01 Edge Filter Specifications	165
D.3: Thermal Considerations	165
D.4: XTL-FA-01 Edge Filter Dimensions.....	166
D.5: XTL-FA-01 Edge Filter Wiring	167
D.6: XTL-FA-01 Edge Filter Ordering.....	171

D.1: Overview

The XTL-FA-01 edge filter can be used to minimize noise on the output of any Xenus amplifier.

D.1.1: Differential and Common Mode Filtering

Most noise is capacitively coupled from the motor power cable to neighboring cables. To minimize this noise, the XTL-FA-01 edge filter uses both differential edge filtering and common mode filtering. Differential edge filtering reduces the high frequency component of the PWM signal, thus producing a signal with less energy that can be coupled during transmission. Common mode filtering reduces the unnecessary common mode noise generated by PWM signals.

D.1.2: Description and Functional Diagram

The differential filter increases the rise time by at least a factor of 3, substantially reducing noise in the system. Copley Controls amplifiers typically have a 150 ns-rise time (high frequency component in the MHz range). Thus, the edge filter can increase rise time to 500 ns, reducing the high frequency noise emissions by the square law. The differential filter is designed with 82 μH inductors and a proprietary passive circuit. The inductance will provide a total of 164 μH in series with the load, helping to reduce ripple current. This brings low inductance motors into the required range.

The common mode filter is designed with a 220 μH common mode toroid that works with the cable capacitance to earth ground to remove common mode switching noise.

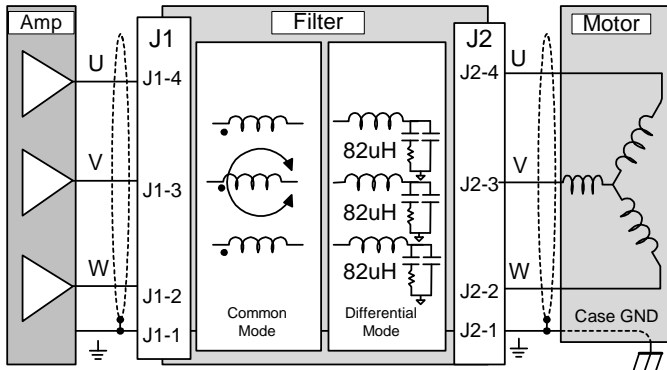

D.1.3: PWM Output Plot

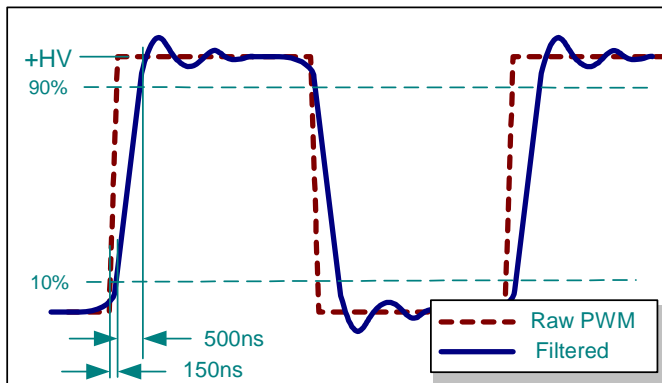

D.2: XTL-FA-01 Edge Filter Specifications

Input	Voltage, maximum	373 Vdc
	Current, maximum	20 Adc
Output	Voltage, maximum	373 Vdc
	Current, maximum	20 Adc
Peak Current/Peak Current Time		40 Adc for 1 second
Rise/Fall Time		500 nS (typical)
Differential Mode Inductance		82 μ H per phase, 162 μ H phase-phase (nominal)
Common Mode Inductance		220 μ H (nominal)
Nominal Resistance		27 milliohms per leg, 54 milliohms phase-phase (nominal)
Agency Approvals		UL508C, EN60204, RoHS

D.3: Thermal Considerations

Cooling Requirements

When used with XTL-230-18 or XTL 230-36 amplifiers, the XTL-FA-01 operates below maximum temperature values, and thus requires no cooling fan.

When used with XTL-40 amplifiers running continuous currents greater than 12 Adc, the XTL-FA-01 should be cooled with an external fan. The fan should have a flow rate of at least 110 CFM. The filter has been tested using the Comair Rotron MD24B2 24 Vdc powered fan.

Fan Mounting Guidelines

Most of the filter's heat is transferred to ambient air, rather than through the heat plate. Thus, it is very important to mount the filter and fan in such a way that the fan can blow up through the filter's cover slots. Mount the filter on edge and mount the fan below it so that it blows up through the cover slots.

There is no heatsink option for the XTL-FA-01 edge filter.

D.4: XTL-FA-01 Edge Filter Dimensions

The following diagram shows the mounting dimensions of the XTL-FA-01 Edge Filter.

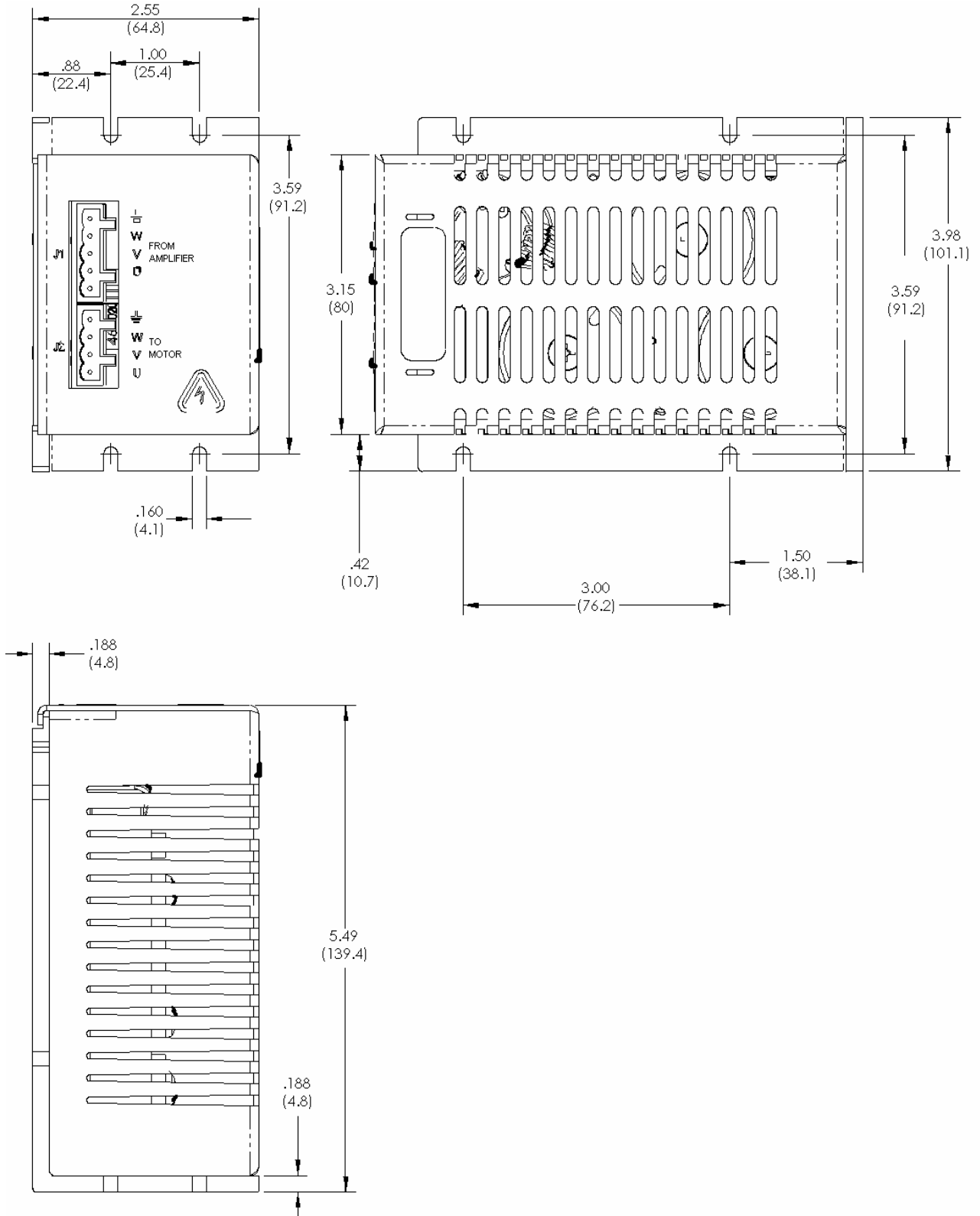

D.5: XTL-FA-01 Edge Filter Wiring

This section describes the wiring of the XTL-FA-01 Edge Filter.

D.5.2: Electrical Codes and Warnings

Be sure that all wiring complies with the National Electrical Code (NEC) or its national equivalent, and all prevailing local codes.



DANGER: Hazardous voltages.

Exercise caution when installing.

Failure to heed this warning can cause equipment damage, injury, or death.

DANGER



Risk of electric shock.

High-voltage circuits on Xenus J1, J2, and J3 and on Filter J1 and J2 are connected to mains power.

Failure to heed this warning can cause equipment damage, injury, or death.

DANGER



Do not ground mains-connected circuits.

With the exception of the ground pins on Xenus J1, J2, and J3 and on Filter J1 and J2, all of the other circuits on these connectors are mains-connected and must never be grounded.

WARNING

Failure to heed this warning can cause equipment damage.

D.5.2: Connector Locations

Edge Filter J1 connects to Xenus J2. Edge Filter J2 connects to the motor.



D.5.3: Cable Notes

- 1 Keep the Edge Filter J1 to Xenus J2 cable as short as possible. A typical length is 7 inches.
- 2 To reduce noise, twisted shielded cable must be used and the signal cables should not be bundled in the same conduit.

D.5.4: Input (J1) From Amplifier

Mating Connector

Description	Euro-style, 5 position, 5.0 mm pluggable female terminal block
Manufacturer PN	Wago 51118042 or 721-105/026-047/RN01-0000
Wire Size	22 - 12 AWG
Recommended Wire	12 AWG, 600 V (Shielded cable used for CE compliance)
Wire Insertion/Extraction Tool	Wago 231-131
Connector and tool are included in connector kit XTL-FK.	

Pin Description

Pin	Signal	Function
1	Ground	Chassis ground and cable shield
2	Phase W	Phase W input from amplifier
3	Phase V	Phase V input from amplifier (use for DC motor connection)
4	Phase U	Phase U input from amplifier (use for DC motor connection)
5	---	No connection

D.5.5: Output (J2) To Motor

Mating Connector

Description	Euro-style, 4 position, 5.0 mm pluggable female terminal block.
Manufacturer PN	Wago 51118008 or 721-104/026-047/RN01-0000
Wire Size	22 - 12 AWG
Recommended Wire	12 AWG, 600 V (Shielded cable used for CE compliance)
Wire Insertion/Extraction Tool	Wago 231-131
Connector and tool are included in connector kit XTL-FK.	

Pin Description

Pin	Signal	Function
1	Ground	Chassis ground and cable shield
2	Phase W	Phase W output to motor
3	Phase V	Phase V output to motor (use for DC motor connection)
4	Phase U	Phase U output to motor (use for DC motor connection)

D.5.6: Diagram: Edge Filter Wiring with Brushless Motor

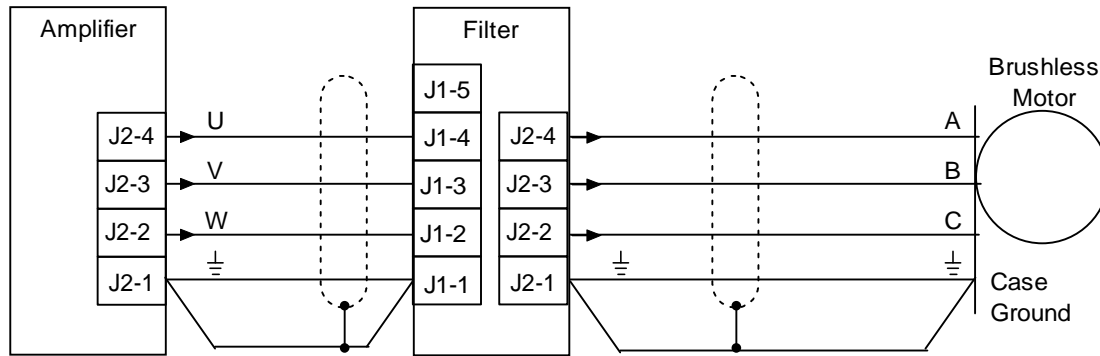

D.5.7: Diagram: Edge Filter Wiring with Brush Motor

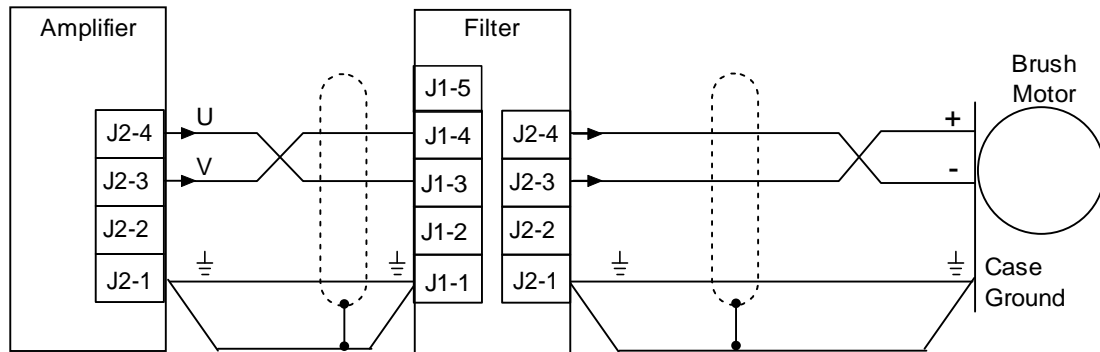

D.6: XTL-FA-01 Edge Filter Ordering

Filter

Model	Description
XTL-FA-01	Xenus Edge Filter

Connector Kit

Model	Qty	Ref	Description	Mfr. Model No.
XTL-FK	1	J1	Plug, 5 position, 5.0 mm, female	Wago 51118042 or 721-105/026-047/RN01-0000
	1	J2	Plug, 4 position, 5.0 mm, female	Wago 51118008 or 721-104/026-047/RN01-0000
	2	--	Insertion / Extraction Tool	Wago 231-131

APPENDIX

E: CONNECTING FOR SERIAL CONTROL

This chapter describes how to connect one or more amplifiers for control via the RS-232 bus on one of the amplifiers.

E.1: Single-Axis and Multi-Drop

An amplifier's RS-232 serial bus can be used by CME 2 for amplifier commissioning. The serial bus can also be used by an external control application (HMI, PLC, PC, etc.) for setup and direct serial control of the amplifier. The control application can issue commands in ASCII format.

For experimentation and simple setup and control, a telnet device such as the standard Microsoft Windows HyperTerminal can also be used to send commands in ASCII format. For more information, see *Copley Controls ASCII RS-232 User Guide*.

The serially connected amplifier can also be used as a multi-drop gateway for access to other amplifiers linked in a series of CAN bus connections.

Instructions for hooking up a single-axis connection and a multi-drop network appear below.

E.1.2: Single-Axis Connections

For RS-232 serial bus control of a single axis, set the CAN node address of that axis to zero (0). Note that if the CAN node address is switched to zero after power-up, the amplifier must be reset or power cycled to make the new address setting take effect.

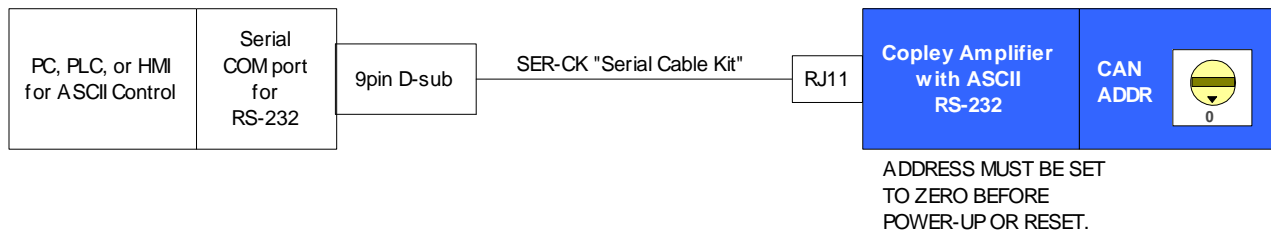

E.1.3: Multi-Drop Network Connections

A serially connected amplifier can be used as a multi-drop gateway for access to other amplifiers linked in a series of CAN bus connections. Set the CAN node address of the serially connected amplifier (gateway) to zero (0). Assign each additional amplifier in the chain a unique CAN node address value between 1 and 127. For more information on CAN node address assignment, see [CAN Addressing \(p. 29\)](#) and [CAN Interface \(p. 109\)](#). Use 120 Ohms termination on the first and last amplifier.

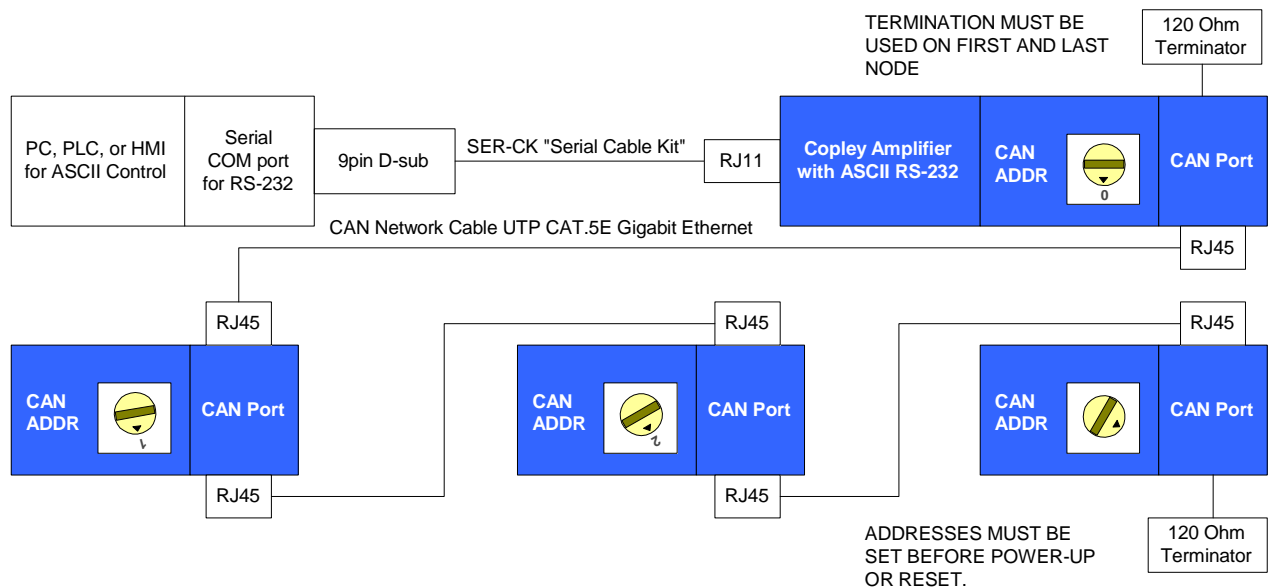

APPENDIX

F: ORDERING GUIDE AND ACCESSORIES

This chapter lists part numbers for amplifiers and accessories. Contents include:

F.1: Amplifier Model Numbers	176
F.2: Accessory Model Numbers.....	177
F.3: Order Example	178
F.5: Copley Standard Regen Resistor Specifications.....	179
F.5.1: Specifications	179
F.5.2: Dimensions.....	179

F.1: Amplifier Model Numbers

Model Number	Description
XTL-230-18	Xenus Servoamplifier 6/18 A
XTL-230-18-HL	Xenus Servoamplifier 6/18 A with factory-fitted, low-profile heatsink
XTL-230-18-HS	Xenus Servoamplifier 6/18 A with factory-fitted, standard heatsink
XTL-230-36	Xenus Servoamplifier 12/36 A
XTL-230-36-HL	Xenus Servoamplifier 12/36 A with factory-fitted, low-profile heatsink
XTL-230-36-HS	Xenus Servoamplifier 12/36 A with factory-fitted, standard heatsink
XTL-230-40	Xenus Servoamplifier 20/40 A
XTL-230-40-HL	Xenus Servoamplifier 20/40 A with factory-fitted, low-profile heatsink
XTL-230-40-HS	Xenus Servoamplifier 20/40 A with factory-fitted, standard heatsink
XTL-230-18-R	Xenus Servoamplifier 6/18 A with resolver feedback
XTL-230-18-R-HL	Xenus Servoamplifier 6/18 A with resolver feedback and factory-fitted, low-profile heatsink
XTL-230-18-R-HS	Xenus Servoamplifier 6/18 A with resolver feedback and factory-fitted, standard heatsink
XTL-230-R-36	Xenus Servoamplifier 12/36 A with resolver feedback
XTL-230-36-R-HL	Xenus Servoamplifier 12/36 A with resolver feedback and factory-fitted, low-profile heatsink
XTL-230-36-R-HS	Xenus Servoamplifier 12/36 A with resolver feedback and factory-fitted, standard heatsink
XTL-230-40-R	Xenus Servoamplifier 20/40 A with resolver feedback
XTL-230-40-R-HL	Xenus Servoamplifier 20/40 A with resolver feedback and factory-fitted, low-profile heatsink
XTL-230-40-R-HS	Xenus Servoamplifier 20/40 A with resolver feedback and factory-fitted, standard heatsink
XTL-230-18-S	Xenus Servoamplifier 6/18 A with sin/cos feedback
XTL-230-18-S-HL	Xenus Servoamplifier 6/18 A with sin/cos feedback and factory-fitted, low-profile heatsink
XTL-230-18-S-HS	Xenus Servoamplifier 6/18 A with sin/cos feedback and factory-fitted, standard heatsink
XTL-230-S-36	Xenus Servoamplifier 12/36 A with sin/cos feedback
XTL-230-36-S-HL	Xenus Servoamplifier 12/36 A with sin/cos feedback and factory-fitted, low-profile heatsink
XTL-230-36-S-HS	Xenus Servoamplifier 12/36 A with sin/cos feedback and factory-fitted, standard heatsink
XTL-230-40-S	Xenus Servoamplifier 20/40 A with sin/cos feedback
XTL-230-40-S-HL	Xenus Servoamplifier 20/40 A with sin/cos feedback and factory-fitted, low-profile heatsink
XTL-230-40-S-HS	Xenus Servoamplifier 20/40 A with sin/cos feedback and factory-fitted, standard heatsink
NOTE: Heatsink kits may be ordered separately.	

F.2: Accessory Model Numbers

Software

Model	Description
CME2	CME 2 Drive Configuration Software (CD-ROM)
CML	Copley Motion Libraries (CD-ROM)
CMO	Copley Motion Objects (CD-ROM)

Connector Kit with Solder-Cup Feedback and Control Connectors

Model	Qty	Ref	Description	Mfr. Model No.
XTL-CK	1	J1	Plug, 4 position, 7.5 mm, female	Wago: 51118287 or 721-204/026-045/RN01-0000
	1	J2	Plug, 4 position, 5.0 mm, female	Wago: 51118008 or 721-104/026-047/RN01-0000
	1	J3	Plug, 5 position, 5.0 mm, male	Wago: 51111279 or 721-605/000-044/RN01-0000
	1	J4	Plug, 3 position, 5.0 mm, female	Wago: 51117974 or 721-103/026-047/RN01-0000
	4	--	Tool, wire insertion and extraction	Wago: 231-131
	1	J7	Connector, High Density D-Sub Male 26 position, solder-cup	Norcomp: 180-026-103L001
	1		Back shell, for 26-pin connector	Norcomp: 939-015-020R121
	1	J8	Connector, High Density D-Sub Male 15 position, solder-cup	Norcomp: 180-015-103L001
	1		Back shell, for 15-pin connector	Norcomp: 939-009-020R121

CANopen Connector Kit

Model	Qty	Ref	Description	Mfr. Model No.
XTL-NK	1	--	Sub-D 9-position female to RJ-45 adapter	
	1	J6	CAN bus Network Cable, 10 ft (3 m)	
	1		CAN bus RJ-45 Network Terminator	

Individual Cable Assemblies (and Related Accessories)

Model	Ref	Description	Mfr. Model No.
SER-CK	J5	RS-232 Serial Cable Kit (for connecting PC to amplifier)	
XTL-CV		Sub-D 9-position female to RJ-45 adapter (PC to CANopen cable adapter)	
XTL-NC-10	J6	CAN bus Network Cable, 10 ft (3 m)	
XTL-NC-01		CAN bus Network Cable, 1 ft (0.3 m)	
XTL-NT		CAN bus Network Terminator	

Heatsink Kit, Low Profile

Model	Qty	Description
XTL-HL	1	Heatsink, low-profile
	1	Heatsink thermal material
	1	Heatsink hardware mounting kit

Heatsink Kit, Standard

Model	Qty	Description
XTL-HS	1	Heatsink, standard
	1	Heatsink thermal material
	1	Heatsink hardware mounting kit

Regen Resistor Assemblies

Model	Description
XTL-RA-03	Regen Resistor Assembly (for use with XTL-230-18)
XTL-RA-04	Regen Resistor Assembly (for use with XTL-230-36 and XTL-230-40)

Edge Filter

Model	Description
XTL-FA-01	Xenus Edge Filter

XTL-FA-01 Edge Filter Connector Kit

Model	Qty	Ref	Description	Mfr. Model No.
XTL-FK	1	J1	Plug, 5 position, 5.0 mm, female	Wago: 51118042 or 721-104/026-047/RN01-0000
	1	J2	Plug, 4 position, 5.0 mm, female	Wago: 51111277 or 721-105/026-047/RN01-0000
	2	--	Insertion / Extraction Tool	Wago 231-131

F.3: Order Example

Order 1 XTL-230-18 amplifier with standard heatsink fitted at the factory, Connector Kit, CME 2 CD, and serial cable kit:

Qty	Item	Description
1	XTL-230-18-HS	Xenus Servoamplifier with standard heatsink installed
1	XTL-CK	Connector Kit with solder cup connectors
1	CME 2	CME 2 CD
1	SER-CK	Serial Cable Kit for connecting the PC to the amplifier

F.5: Copley Standard Regen Resistor Specifications

F.5.1: Specifications

Specifications for Copley’s standard regen resistors are described below.

Model	Resistance	Default Continuous Power	Max Continuous Power	Peak Power	Peak Power Time	For Use With
XTL-RA-03	30 ohms	65 W	400 W	5 kW	1000 ms	XTL-230-18 XTL-230-18-R XTL-230-18-S
XTL-RA-04	15 ohms	65 W	400 W	10 kW	1000 ms	XTL-230-36 XTL-230-36-R XTL-230-36-S XTL-230-40 XTL-230-40-R XTL-230-40-S



WARNING

High Temperature Risk.

Setting Default Continuous Power for a standard Copley regen resistor to a value greater than the default of 65 W may cause the resistor casing to heat to temperatures that could cause injury. If higher settings are required, contact Copley Controls customer support.

Failure to heed this warning can cause equipment damage or injury.

F.5.2: Dimensions

The diagram below shows XTL-RA-03 and XTL-RA-04 mounting dimensions (in mm).

