



Industrial Panel PCs and Displays HMI solutions for the operation and visualisation of machines and systems

adstec

Industrial IT

Panel PCs and displays (monitors) in wide-screen form factor ADS-TEC operating devices have already been tried and tested many times in harsh environments and perform their services reliably. As HMI with touch-screen operation for numerous customer applications for control and visualisation, they are uncompromisingly reduced to the essential, optimised in every detail, powerful and durable. Technology 100% made in Germany.

Panel PCs OPC7000 series

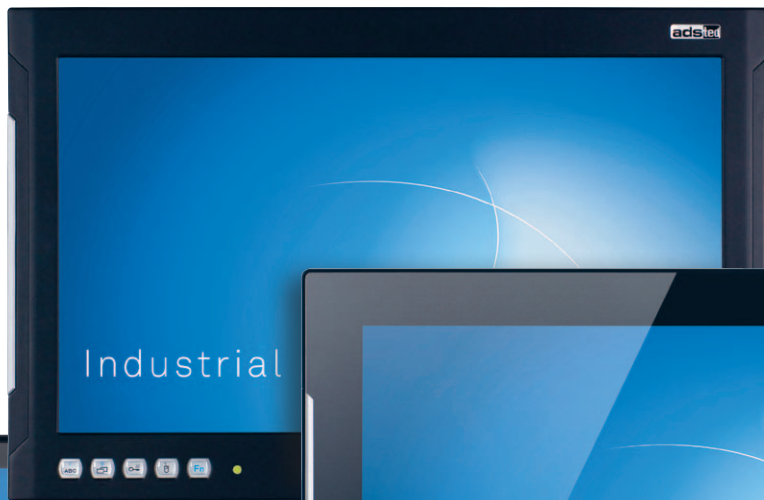

Panel PCs OPC8000 series

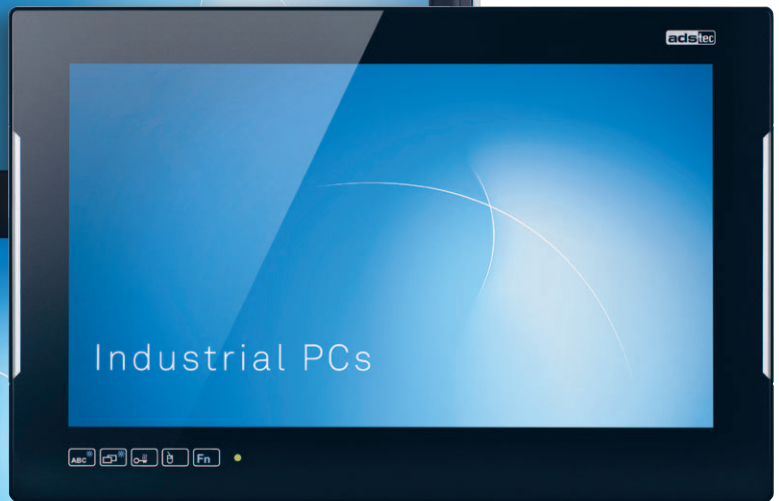

Panel PCs and Displays OPC/OPD8017/8024



Industrial IT platforms for production environments **Technology for Professionals**

You can count on it. ADS-TEC has been providing up-to-date and powerful PC technology with an industry-orientated design for more than three decades. 100% depth of development and state of the art processes form the basis for customer-related products and individual solutions. Technology 100% made in Germany – a good feeling for ADS-TEC customers.



OPC/OPD8000 series **Added values**

- Panel PCs in six different sizes for numerous customer applications
- Monitors with outstanding touch performance in two sizes
- Robust systems with award-winning design and high performance
- Practical five front keys for selected variants
- Everything from a single source: Even more possibilities with the ADS-TEC software tools Big-LinX and X-Remote
- Additional security with the ADS-TEC service packages

OPC/OPD8000 series **Areas of application**

- Operating and monitoring in machine and plant construction
- Monitoring and control in switch cabinet construction
- Visualisation and operation in packaging industry and automotive area

ADS-TEC Industrial Panel PCs and Displays at a glance



OPC7000 series Panel PCs with resistive industrial touch-screen

- Widescreen form factor in 8", 13.3", 15.4" and 21.5"
- Sturdy aluminium die-cast case
- Rear service access to the mass storage, RAM, VGA, 15-pin HDSUB, battery and fan
- Front USB



OPC8000 series Panel PCs with capacitive multi-touch technology

- Widescreen form factor in 8", 13.3", 15.4" and 21.5"
- Sturdy aluminium die-cast case
- Rear service access to the mass storage, RAM, VGA, 15-pin HDSUB, battery and fan
- Multi-finger operation thanks to PCAP multi-touch



OPC8017/8024 The fanless terminals

- Panel PC with capacitive multi-touch technology
- 17.3" and 23.8" full HD widescreen display
- Fanless device concept with passive cooling
- Multi-finger operation thanks to PCAP multi-touch
- UL certification in acc. with UL 61010-1



OPD8017/80124 The fanless displays

- Monitor solution with capacitive multi-touch technology
- 17.3" and 23.8" full HD widescreen display
- Fanless device concept with passive cooling
- Multi-finger operation thanks to PCAP multi-touch
- UL certification in acc. with UL 61010-1

OPC7000 Series Product Benefits

HMI solutions for operation, visualisation and control **Tried and tested, reliable, robust**

The award winning OPC7000 and OPC8000 series operating devices are specially tailored for operation and monitoring in demanding industrial environments and are resistant even to extreme loads. The right choice if you are looking for a high-performance HMI solution.

OPC7000 series **Proven and reliable in harsh environments**

- 5-wire resistive industrial touch-screen
- Front panel made of glass-fibre reinforced plastic (painted)
- Front USB
- UL-Certification for Information Technology Equipment (UL 60950-1)*



reddot design award
winner 2010



Designpreis
Deutschland
2011
NOMINIERT

OPC8000 Series Product Benefits

HIGHLIGHTS

- OPC8000 series Panel PCs with the latest multi-touch technology
- Thermally treated front glass – robust and stable
- The latest operating systems with Windows® 10 IoT Enterprise



OPC8000 series Outstanding design and state-of-the-art technology

- Capacitive multi-touch technology
- Thermally treated front glass – robust and stable
- Extremely low reflection for optimum viewing
- Pleasant feel and non-sparkling effect
- Modern and high-quality design



reddot design award
winner 2013



Flexible operation State-of-the-art multi-touch technology

- Multi-finger operation thanks to PCAP multi-touch
- Simple and intuitive: drag, swipe, rotate, zoom
- Convenient operation of machines and systems

OPC7000 and OPC8000 Series Product Benefits

Panel PCs from ADS-TEC **Reliable in harsh environments**

- Display sizes in the latest full HD wide-screen form factor 8", 13.3", 15.4" and 21.5"
- Five tried-and-tested, robust front keys
- Sturdy aluminium die-cast case
- Extended temperature range -20 °C to +60 °C*
- Convenient service access to hard disk, mSATA, RAM, VGA HD-SUB 15-pin connector, battery and fan

Technology **Reduced to the essentials**

- Powerful cooling system permits high processor performance, even at demanding operating temperatures
- Three (with 8") or up to five rear USB interfaces, optionally with fast USB 3.0**
- Serial interface (9-pin D-SUB RS232)
- Two (with 8") or three independent 10/100/1000 Ethernet ports
- 24 VDC power supply
- Industrial FLASH storage system / 2.5" SATA
- CMOS backup battery 1/2AA with 850 mAh (4-times higher capacity than the standard)



* Only with mSATA variants with extended temperature range

** For details, see Technical Data on page 14 and 16



Panel mounting **Quick and easy**

- Captive clamping fixtures integrated in the panel
- Simple locking thanks to Quick-Snap
- Retraction of the clamping pieces using finger or screwdriver
- Easy access even in the case of narrow installation situations
- Force transmission into robust die-cast case

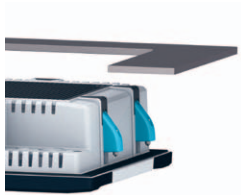

Step 1

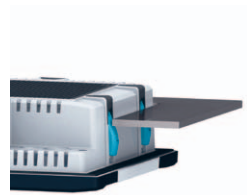

Step 2



Step 3



Step 4

Quick mounting of the Panel PCs thanks to Quick-Snap*



Optional aluminium casing **All-round protection to IP54***

- IP54 all-round protection against dust and splash water
- Rear service access – cable connections easily interchangeable
- Mounting suitable for VESA 75 and VESA 100 bracket

* Not applicable for OPC7008 and OPC8008

OPC8017/8024 Product Benefits

The fanless Panel PCs **Clearly structured, fanless and reduced to the essentials**

The latest OPC8017/8024 operating devices make convenient control and monitoring of machines, systems and processes in full HD resolution possible. With economical Intel® processors, quick flash storage systems and Windows® 10 IoT Enterprise, this Human Machine Interface combines everything that you require for efficient visualisation and control.



OPC8017/8024 **The fanless HMI terminals**

- Display sizes in the latest wide-screen form factor in 17.3" and 23.8" full HD
- Clearly structured visualisation and control of machines and systems
- Chemically toughened and anti-reflective front panel
- Convenient multi-finger operation using PCAP multi-touch – even with gloves
- Fanless device concept with passive cooling
- Simple replacement of the 2.5" SSD and CMOS battery without opening the device



Certifications **OPC8017/8024**

- UL listed for USA and Canada (UL 61010-1, UL 61010-2-201)
- CCC confirmation for China
- CE for Europe

OPD8017/8024 Product Benefits

The fanless monitor solutions **Clearly structured, expandable and reduced to the essentials**

With the modern OPD8017/8024 full-HD displays as monitor solutions, clearly structured visualisation becomes possible in your process environment. Simple connection to the computer environment is possible via the HDMI/DP display input, and the existing USB 2.0 interface makes it possible to connect the most popular USB peripheral devices.

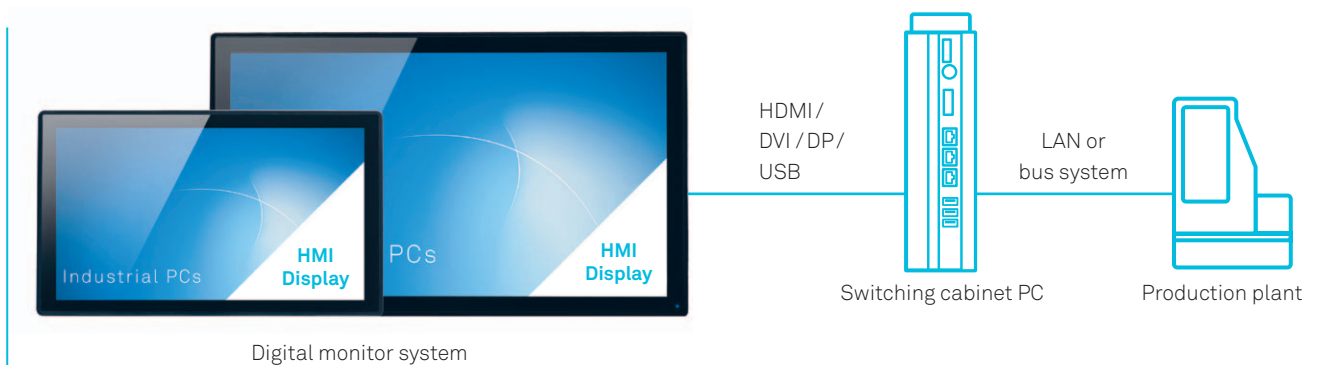

OPD8017/8024 Displays as fanless monitor solutions

- Display sizes in the latest wide-screen form factor in 17.3" and 23.8" full HD
- Clearly structured visualisation of your processes
- Chemically toughened and anti-reflective front panel
- Convenient multi-finger operation using PCAP multi-touch – even with gloves



Certifications **OPD8017/8024**

- UL listed for USA and Canada (UL 61010-1, UL 61010-2-201)
- CCC confirmation for China
- CE for Europe

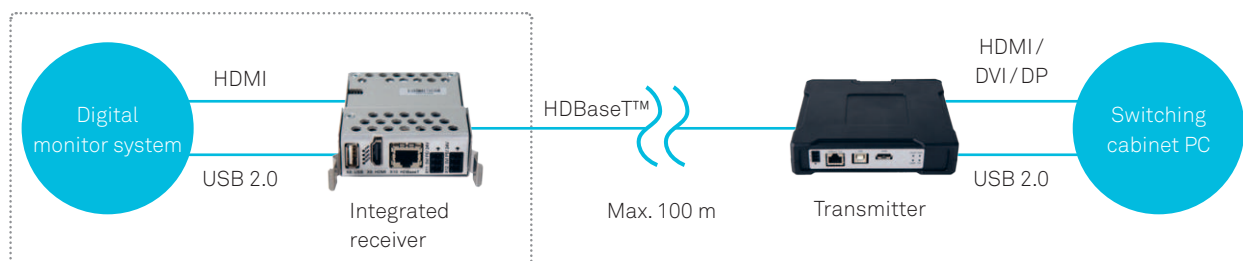

HDBaseT™ Extender Kit **The additional option for longer distances**

Bridges distances between computer and monitor of up to 100 m by extending with the HDBaseT™ Extender Kit

- Extender Kit consisting of receiver module for installation in the OPD and transmitter module for installation in the switch cabinet

Panel PCs even better with ADS-TEC software tools

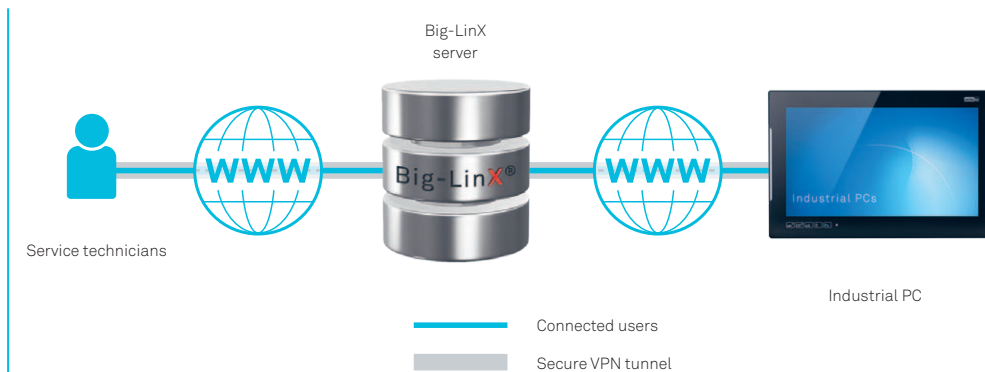

Secure connection in the event that service should be necessary **With the ADS-TEC Big-LinX® remote management client**

With the Windows-based client, always stay securely connected to ensure smooth operation with the OPC series.

- Secure connection by means of Smartcard-secured VPN tunnel
- Software, firmware and BIOS are always kept up-to-date via the connection to the ADS-TEC IoT service platform Big-LinX

With Big-LinX, a central platform for remote maintenance of any number of terminals is available for technicians or service groups.

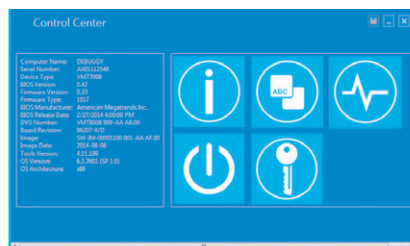

Configuration Center **Customised settings quick and easy**

- USB lock to protect against unauthorised access
- Option of soft keyboard configuration
- Front panel keys for customer-specific assignment

X-Remote®

X-Remote® Duplication and remote operation of PC desktops via local networks and the Internet



Your advantages at a glance

- Direct real-time control and operation of distributed systems and processes with the ADS-TEC remote control software »X-Remote«
- Windows-based PC monitor surfaces, including the operation thereof, can be duplicated and dynamically adapted to display screen resolutions
- Simple construction of a monitoring centre in a network in which multiple remote desktops can be displayed on one screen and operated if necessary
- X-Remote can also be set up on mobile terminals for operation and monitoring – even via WLAN

ADS-TEC Service – more security

ADS-TEC service packages **Extended Warranty in Basic, Silver and Gold or comprehensive protection with »Full Comprehensive Coverage FCC«**

In order to cover technical malfunctions it is possible, beyond the statutory warranty, to purchase an ADS-TEC industrial IT product for an extended service. In this way, it is possible to have longer-term protection against repair costs due to technical malfunctions.

| | without service package |  |  |  |
|---------------------------------------------------------------------------|-------------------------|-----------------------------------------------------------------------------------|------------------------------------------------------------------------------------|-------------------------------------------------------------------------------------|
| Protection against technical malfunctions | – * | ✓ | ✓ | ✓ |
| Contract term | – * | 36/60 months | 36/60 months | 36/60 months |
| Processing time for the industrial IT products in event of service | 20 AT | 10 AT | 5 AT | 3 AT |
| Protection against mechanical damages | – * | – | – | – |

ADS-TEC Services **Overview of the packages**

With the Basic, Silver and Gold packages, defined reaction times during 36 or 60 months can be specified for the repair, in order to keep the downtime as short as possible. These are calculated in working days (AT) from arrival of the Service Article at ADS-TEC until once again returned to the transport provider after successful repair, exclusive of any possible period subject to a cost estimate (for a repair outside of the guarantee service).

| | without service package |  |
|--------------------------------------------------------------------------|-------------------------|--------------------------------------------------------------------------------------|
| Repair costs are accepted, even in the event of mechanical damage | – * | ✓ |

ADS-TEC Services **Comprehensive protection »Full Comprehensive Coverage FCC«**

»Comprehensive Coverage« is the service which is comparable to fully comprehensive insurance for industrial computing products, which also takes effect in the event of sudden and externally-caused defects such as damage caused by a fall or the mechanical destruction of a touch-screen. All repair costs are covered.

ADS-TEC Services **Services & customising made to measure**

Tailored to your requirements, we provide other services such as the planning and implementation of roll-outs or the customising of operating systems and applications such as soft keyboards and RFID. Our made-to-measure service, support and maintenance agreements also ensure that you have the best possible support over the entire service life.

*only contractually agreed warranty

OPC7000 Series Technical Data

Device data

| | OPC7008 | OPC7013 | OPC7015 | OPC7022 |
|---------------------------------------------|------------------------------------------------------------------|------------------------------------------------------------------------------------------------------------------------------------------------------------------------|------------------------------------------------------------------------------------------------------------------------------------------------------------------------------------------------------|--------------------------------------------------|
| Housing | Die-casting aluminium, powder-coated | | | |
| Front panel | Glass-fibre reinforced plastic, painted | | | |
| Display | LED backlight Resolution Display colours | 8" TFT 800 x 480 pixels max. 256k | 13.3" TFT 1280 x 800 pixels max. 256k | 15.4" TFT 1280 x 800 pixels max. 16.2 Mio. |
| | Manual brightness adjustment of the display | | | |
| Touch | Resistive industrial touch-screen | | | |
| Processor/ Graphics controller** | Intel Atom® N2600 1.6 GHz Intel® GMA3600 ¹ | Intel® Celeron® 847E 1.10 GHz Intel® Core™ i5-2515E 2.50 GHz Intel® Core™ i7-2655LE 2.20 GHz Intel® Celeron® 2002E 1.50 GHz Intel® Core™ i5-4400E 2.70 GHz | Intel® HD Graphics ² Intel® HD Graphics 3000 ² Intel® HD Graphics 3000 ² Intel® HD Graphics ³ Intel® HD Graphics 4600 ³ | |
| RAM | 4 GB DDR3 | 4 GB DDR3 8 GB DDR3 | | |
| Mass storage | mSATA SSD mSATA SSD Industrial | 2.5" HDD SATA mSATA SSD mSATA SSD Industrial | | |
| Interfaces | 1 x COM 1 (RS232) Rear: 3 x USB 2.0 Front: 1 x USB 2.0 | | Rear: 5 x USB 2.0 Front: 1 x USB 2.0 With Celeron® 847E, Core™ i5-2515E, Core™ i7-2655LE or Rear: 2 x USB 2.0 & 2 x USB 3.0 Front: 1 x USB 2.0 With Celeron® 2002E, Core™ i5-4400E | |
| Network | 2 x 1 Gbit/s Ethernet RJ45 | 3 x 1 Gbit/s Ethernet RJ45 | | |
| Power adapter | 24 VDC +/- 20% (19 to 29 VDC) | | | |
| Operating system | Windows Embedded Standard 7 (32 Bit) | Windows Embedded Standard 7 (32 Bit / 64 Bit) Windows 7 Ultimate (32 Bit / 64 Bit) Windows 10 IoT Enterprise (64 Bit) | | |
| Protection class | IP65 at front | | | |
| Operating temperature | 0 °C to +55 °C -20 °C to +60 °C* | 5 °C to +45 °C, -20 °C to +60 °C* | | 5 °C to +45 °C |
| Dimensions (W x H x D) | 256 x 192 x 66 mm | 353 x 261 x 64 mm | 413 x 290 x 68 mm | 553 x 355 x 68 mm |
| Installation depth | 64 mm | 64 mm | 68 mm | 68 mm |
| Installation recess*** (W x H) | 240 x 176 mm | 332 x 240 mm | 392 x 269 mm | 532 x 334 mm |
| Weight | 1.9 kg | 2.8 kg | 4.1 kg | 7.5 kg |
| Vibration resistance | DIN EN 60068-2-6 | | | |
| Shock resistance | DIN EN 60068-2-27 | | | |
| Humidity | 10 to 85% non-condensing | | | |

* Only with mSATA variants with mSATA SSD Industrial ** Shared memory *** Tolerance +/- 1 mm

¹DirectX 9.0 and OpenGL 3.0 support ²DirectX 10.1 and OpenGL 3.1 support ³DirectX 11.1 and OpenGL 4 support

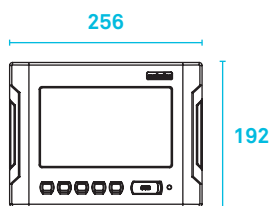

OPC7008

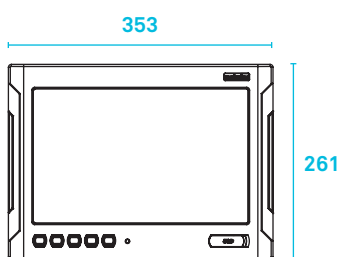
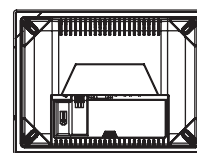
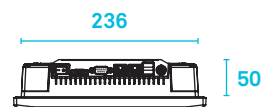
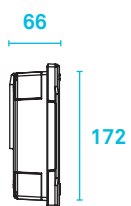

OPC7013

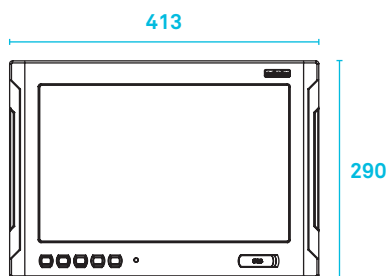
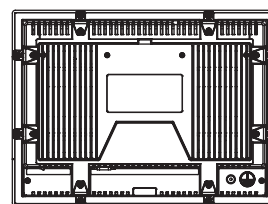
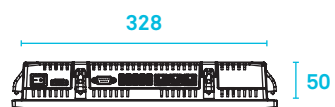
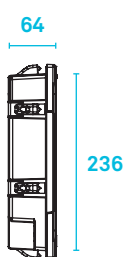

OPC7015

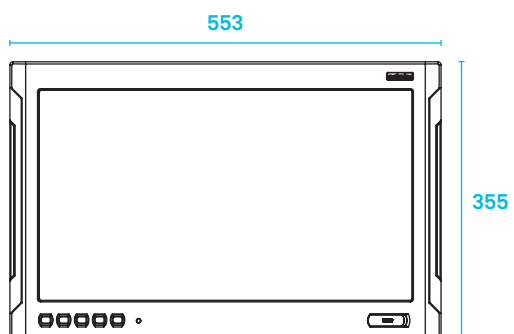
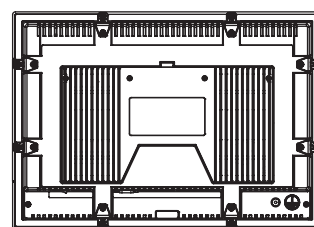
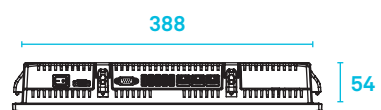
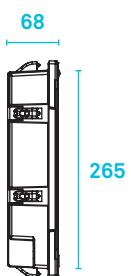

OPC7022

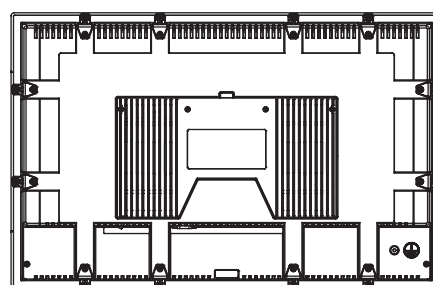
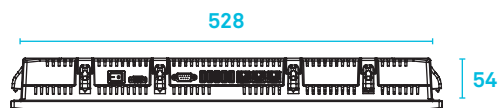
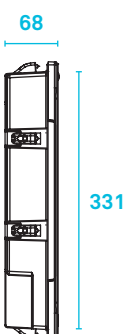

OPC8000 Series Technical Data

Device data

| | OPC8008 | OPC8013 | OPC8015 | OPC8022 |
|------------------------------------------|----------------------------------------------------------------------------|------------------------------------------------------------------------------------------------------------------------------------------------------------------------|--------------------------------------------------------------------------------------------------------------------------------------------------------------------------------------------|----------------------------|
| Housing | Die-casting aluminium, powder-coated | | | |
| Front panel | 3 mm glass panel, thermally toughened and anti-reflective | | | |
| Display | 8" TFT LED backlight | 13.3" TFT LED backlight | 15.4" TFT LED backlight | 21.5" TFT LED backlight |
| Resolution | 800 x 480 pixels | 1280 x 800 pixels | 1280 x 800 pixels | 1920 x 1080 pixels |
| Display colours | max. 262k | max. 262k | max. 16.2 mill. | max. 16.7 mill. |
| | Manual brightness adjustment of the display | | | |
| Touch | PCAP multi-touch | | | |
| Processor/ Grafikcontroller** | Intel Atom® N2600 1.6 GHz Intel® GMA3600 ¹ | Intel® Celeron® 847E 1.10 GHz Intel® Core™ i5-2515E 2.50 GHz Intel® Core™ i7-2655LE 2.20 GHz Intel® Celeron® 2002E 1.50 GHz Intel® Core™ i5-4400E 2.70 GHz | Intel® HD Graphics ² Intel® HD Graphics 3000 ² Intel® HD Graphics 3000 ² Intel® HD Graphics ³ Intel® HD Graphics 4600 ³ | |
| RAM | 4 GB DDR3 | 4 GB DDR3 8 GB DDR3 | | |
| Mass storage | mSATA SSD mSATA SSD Industrial | 2.5" HDD SATA mSATA SSD mSATA SSD Industrial | | |
| Interfaces | 1 x COM 1 (RS232) | | | |
| | Rear side: 3 x USB 2.0 | Rear: 5 x USB 2.0 With Celeron® 847E, Core™ i5-2515E, Core™ i7-2655LE or Rear: 2 x USB 2.0 & 2 x USB 3.0 With Celeron® 2002E, Core™ i5-4400E | | |
| Network | 2 x 1 Gbit/s Ethernet RJ45 | 3 x 1 Gbit/s Ethernet RJ45 | | |
| Power adapter | 24 VDC +/- 20% (19 to 29 VDC) | | | |
| Operating system | Windows Embedded Standard 7 (32 Bit), Windows 7 Ultimate (32 Bit) | Windows Embedded Standard 7 (32 Bit / 64 Bit) Windows 7 Ultimate (32 Bit / 64 Bit) Windows 10 IoT Enterprise (64 Bit) | | |
| Protection class | IP65 at front | | | |
| Operating temperature | 0 °C to +55 °C -20 °C to +60 °C* | 5 °C to +45 °C, -20 °C to +60 °C* | | 5 °C to +45 °C |
| Dimensions (W x H x D) | 258 x 194 x 62 mm | 353 x 261 x 63 mm | 426 x 303 x 66 mm | 567 x 369 x 66 mm |
| Installation depth | 65 mm | 65 mm | 69 mm | 69 mm |
| Installation recess*** (W x H) | 240 x 176 mm | 332 x 240 mm | 392 x 269 mm | 532 x 334 mm |
| Weight | 1.8 kg | 3.6 kg | 4.9 kg | 8.6 kg |
| Vibration resistance | DIN EN 60068-2-6 | | | |
| Shock resistance | DIN EN 60068-2-27 | | | |
| Humidity | 10 to 85% non-condensing | | | |

* Only with mSATA variants with extended temperature range ** Shared memory *** Tolerance +/- 1 mm

¹DirectX 9.0 and OpenGL 3.0 support ²DirectX 10.1 and OpenGL 3.1 support ³DirectX 11.1 and OpenGL 4 support

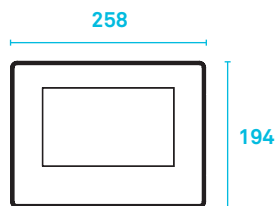

OPC8008

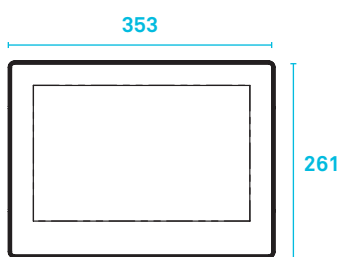
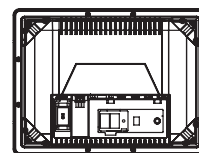
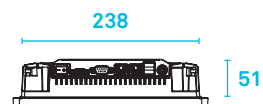
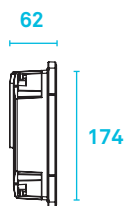

OPC8013

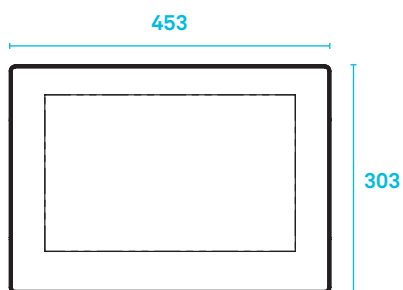
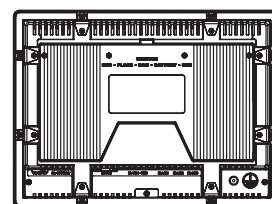
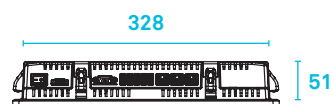
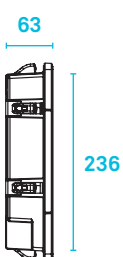

OPC8015

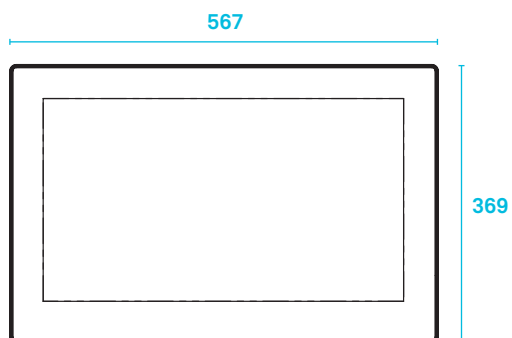
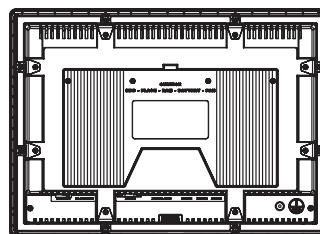
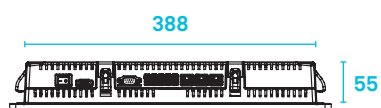
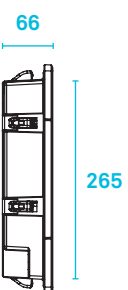

OPC8022

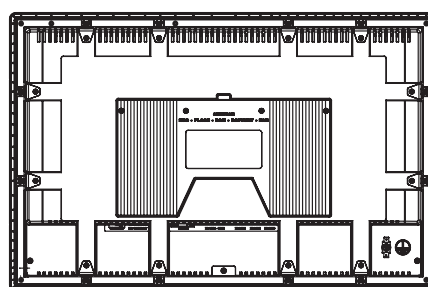
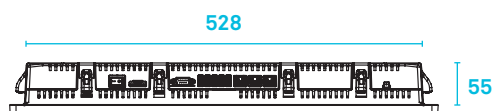

OPC/OPD8017/8024 Technical Data

Device data

| | OPC8017 | OPC8024 | OPD8017 | OPD8024 |
|-------------------------------------|-------------------------------------------------------------------------------------------------------------------------------------|----------------------------|----------------------------------------------------------------|----------------------------|
| Housing | Galvanised sheet-metal housing | | | |
| Front panel | 3 mm glass panel, thermally toughened and anti-reflective | | | |
| Display | 17.3" TFT LED backlight | 23.8" TFT LED backlight | 17.3" TFT LLED backlight | 23.8" TFT LED backlight |
| Resolution | 1920 x 1080 pixels | 1920 x 1080 pixels | 1920 x 1080 pixels | 1920 x 1080 pixels |
| Display colours | max. 16.7 Mio. | max. 16.7 Mio. | max. 16,7 Mio. | max. 16.7 Mio. |
| | Manual brightness adjustment of the display | | | |
| Touch | PCAP multi-touch made of toughened glass | | | |
| Processor | Intel® Celeron™ 1.6 GHz (2980U) Intel® Core™ i5 1.9 GHz (4300U) | | - | - |
| RAM | 4 GB DDR3 8 GB DDR3 | | - | - |
| Mass storage | mSATA SSD Industrial 2.5" SSD SATA | | - | - |
| Interfaces | 1 x USB 2.0 2 x USB 3.0 1 x SD card slot | | 1 x HDMI, 1 x display port 3 x USB 2.0 1 x USB 2.0 slave | |
| Network | 2 x 1 Gbit/s Ethernet RJ45 | | - | |
| Power adapter | 24 VDC +/- 25 % (18 to 30 VDC) | | | |
| Operating system | Windows Embedded Standard 7 (64 Bit) Windows 7 Ultimate [for Embedded Systems] (64 Bit) Windows 10 IoT Enterprise (64 Bit) | | - | - |
| Protection class | IP65 at front, IP20 at rear (not verified by UL, tested by ADS-TEC) | | | |
| Operating temperature | 0 °C to +50 °C | 0 °C to +45 °C | 0 °C to +50 °C | 0 °C to +45 °C |
| Dimensions (W x H x D) | 433 x 263 x 88 mm | 580 x 349 x 88 mm | 433 x 263 x 72 mm | 580 x 349 x 72 mm |
| Installation depth | 83 mm | 83 mm | 77 mm | 77 mm |
| Installation recess* (W x H) | 422 x 252 mm | 569 x 338 mm | 422 x 252 mm | 569 x 338 mm |
| Weight | 4.8 kg | 8.1 kg | 4,5 kg | 7,8 kg |
| Vibration resistance | EN 60068-2-6 3M5 (in accordance with 60721-3-3) | | | |
| Shock resistance | EN 60068-2-27 3M5 (in accordance with 60721-3-3) | | | |
| Humidity | 10 to 85% non-condensing | | | |

*Tolerance +/- 0.3 mm

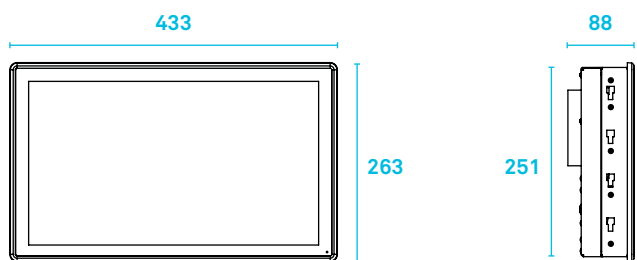

OPC8017

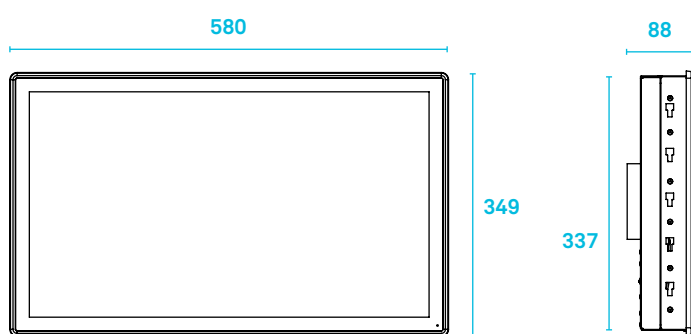
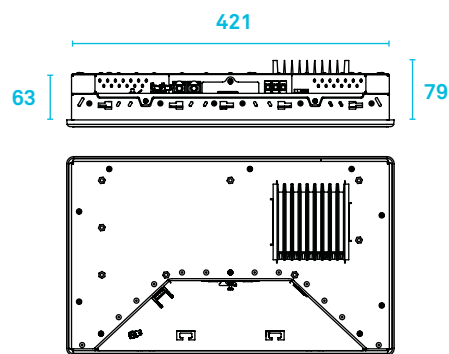

OPC8024

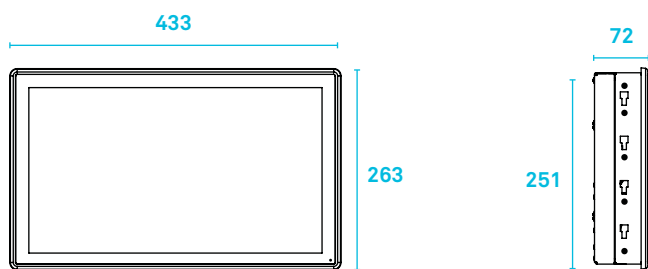
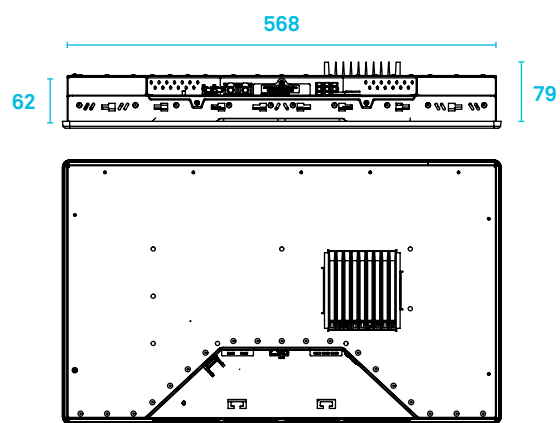

OPD8017

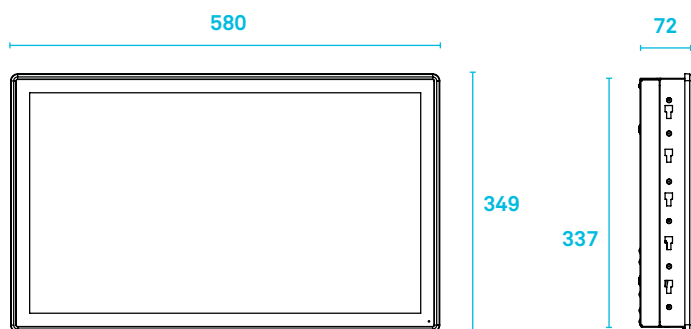
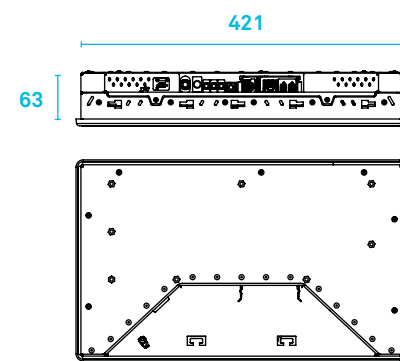

OPD8024

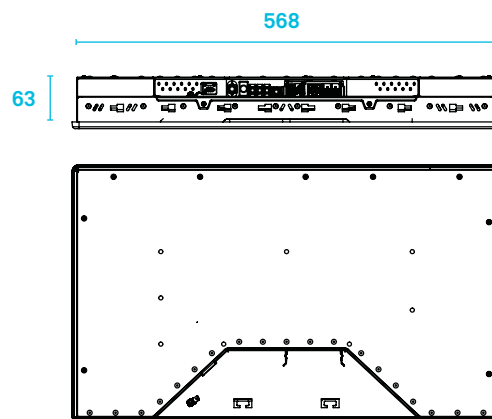



Company headquarters (above) in Nürtingen near Stuttgart, production site in Wilsdruff near Dresden

ads-tec GmbH **A strong partner**

- Products from ADS-TEC have been developed in-house for over 35 years
- 100% depth of development is the basis for long-term and individual solutions
- Services: concept, excellent design, development, fabrication and long-term support
- Modern processes for development, supply chain management, production and service
- References and applications: e.g., automation, logistics, medicine and the construction equipment industry as well as network operators, energy suppliers and public utilities
- International certifications for IT products and battery storage
- In-house laboratory and testing facilities
- Highest safety standards
- Leading technology and current technological standards
- Permanent technology transfer in cooperation with universities
- Intel® Technology Provider Platinum Partner and member of the Intel® Internet of Things Solutions Alliance
- Involvement in networks and associations
- Numerous ADS-TEC research projects funded by federal and state governments

Technology 100% made in Germany



Technology
Provider
Platinum 2018



 TECHNOLOGY
MADE IN GERMANY

adstec

Industrial IT